

NEW!
INTERACTIVE PDF
Click on the underlined text

BILZ

TAPPING PRODUCTS & ADVANCED SOLUTIONS

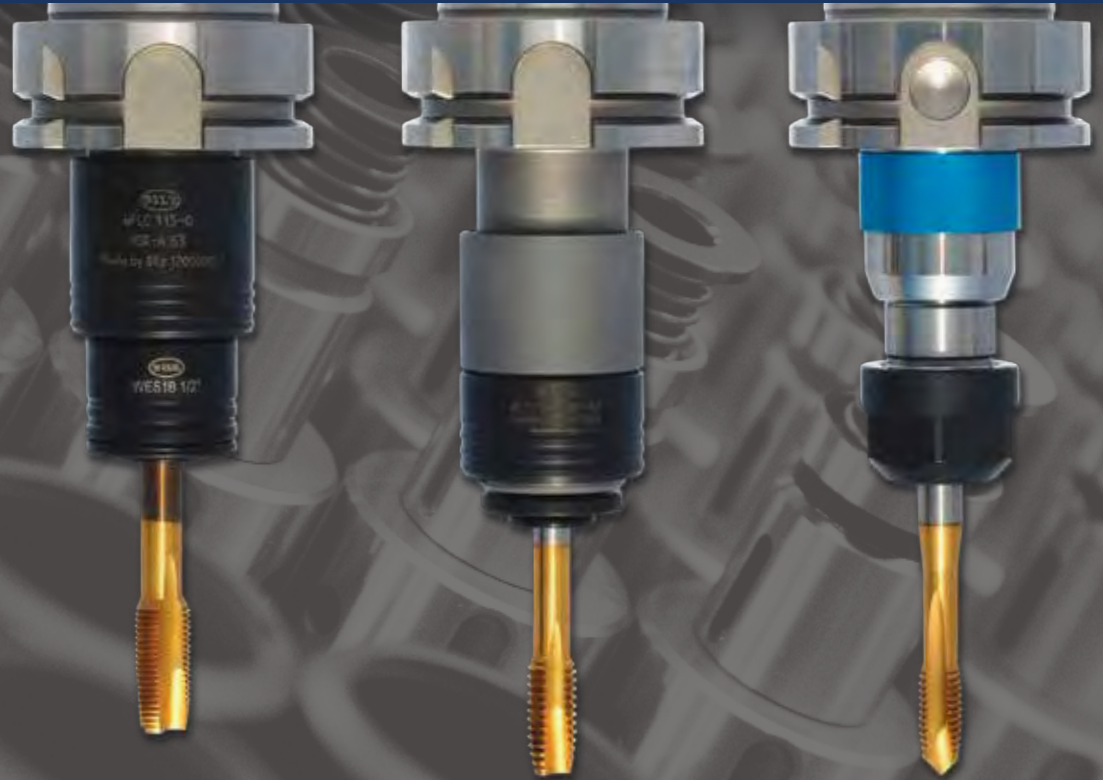

INNOVATION | PERFORMANCE | QUALITY

www.bilzusa.com



BILZ

we hold our promise

The Foundation. For over 90 years, Bilz has been a leading supplier of tool holders, tapping technology and shrink fit systems. The main reason for this success is our people. Bilz has over 350 experienced and motivated individuals working every day to improve and enhance the products we offer. Our goal is to improve your manufacturing processes with a complete set of solutions that are efficient and dependable. As a result, we have become an innovative and trusted partner to companies around the world in industries including aerospace, automotive, die mold & machining, medical equipment and power generation.





Dear Reader,

As everyone knows, money is made at the “cutting edge”. The productivity of this cutting edge influences the total costs of cutting processes, while its share of total manufacturing costs amounts to only 4–6%.

Most production and cutting experts will agree with these statements.

What is required to fully profit from the performance of the cutting edge and increase tool life? This catalog will support you in selecting the optimal clamping tools for your “cutting edges”.

Our long experience as a traditional family-run company helps us to develop products you can rely on . Bilz has compiled a comprehensive product range in this catalog. Many improvements have been included.

“Always better” is not just a slogan for us. It is a promise, our commitment to quality. We and our products keep our promises. In addition to this product range we can offer you various custom-designed solutions.

Please talk to us about new solutions for your applications.

Many people react, we act.

On behalf of the whole Bilz Team,

A handwritten signature in blue ink, appearing to be "H. Bilz".



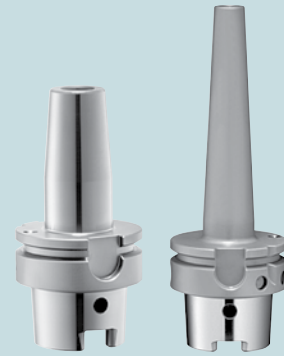

TAPPING

(MQL) MINIMUM QUANTITY LUBRICANT

INDUCTION SHRINK-FIT SYSTEM

For decades, Bilz has been the global leader in tapping technology. Quality engineered and well designed, Bilz tap holders are the industry standard.

Special features like length compensation (tension/compression), quick change, parallel float, internal coolant or external coolant are incorporated in many different combinations in our chucks.

ADVANTAGES

- Faster Tool Set-ups
- Increased Tap Life
- Improved Thread Quality
- Faster Tool Changes

APPLICATIONS

- Tapping and thread forming on all possible applications with many different machine spindle connections.



Minimum Quantity Lubricant (MQL) technology provides unmatched efficiency in coolant delivery. The system delivers coolant immediately upon start-up with consistent pressure, and the optimized sealed design provides a leak-free coolant stream.

Reduced coolant usage and coolant handling leads to a safer workplace, lower maintenance costs, and a smaller impact on the environment. MQL is available in Shrink Fit holders and Synchro Chuck holders.

ADVANTAGES

- More efficient coolant consumption
- Environmentally friendly
- Up to 100% increase in tool life
- Reduce coolant costs up to 19%

APPLICATIONS

- Perfect for any application where safer and more-efficient coolant usage is desired. Specific industries include Aerospace, Automotive, Die & Mold, Medical Equipment and more.



The finest shrink fit holders available. Precise manufacturing and our exclusive “counter bore” technology optimize the advantages of using shrink fit tooling. Combine the Bilz ThermoGrip holders with the Bilz ThermoGrip machines and you have the ultimate shrink fit system.

Bilz holders offer the best part finish quality, longer tool life, and higher feed rates and speeds. All of this is accomplished due to micrometer accuracy in runout, high cutting tool rigidity and extremely high clamping forces.

TOOL OPTIONS

- Standard chucks
- Slimline chucks
- Heavy duty (thick walled) chucks
- JetSleeve
- TER shrink-fit collets

APPLICATIONS

- Milling, drilling and reaming
- Milling and reaming on driven tooling
- Micro milling applications





CNC HOLDERS

Our CNC Holder line provides options for all industry-standard sizes and configurations for collet chucks, end mill holders, shell mill holders, hi-power milling chucks, and face mill holders.

Each product represents the latest technology, and reflects our commitment to quality and innovation. We also support our products with unmatched application expertise and customer service.

ADVANTAGES

- Latest tool holding technology
- Extensive product line
- Strong, high-quality products
- Very accurate and durable

APPLICATIONS

- CNC holders are used in a variety of industries including Aerospace, Automotive, Die & Mold, Medical Equipment and more.



FLOATING HOLDERS

Bilz Floating Holders enable the serial production of perfectly aligned reamed bores with the automatic centering of the reamer after every cycle, protecting the reamer from any side forces.

Our Floating Holders can be used horizontally or vertically and can be delivered with internal coolant supply and integrated length adjustment.

ADVANTAGES

- Axial float without play
- Maintenance free
- Adjustable centering
- High coolant pressure

APPLICATIONS

- Using reamer tools where the machining spindle and the bore in the workpiece are not 100% aligned.
- Used in transfer lines, lathes and custom machinery

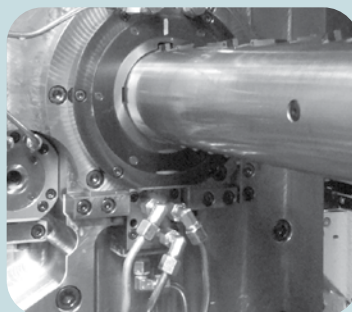

SPECIAL TOOL HOLDERS

Our Specialty Holders represent a unique set of products that offer cost-effective capabilities you won't find from any other manufacturer. In fact, nearly all Special Holders can demonstrate a substantial cost savings when compared to other methods.

ADVANTAGES

- Expand your capabilities
- Make your spindle more productive
- Meet unique customer requirements
- Open a new range of potential

APPLICATIONS

- Specialty tool holders can be used to help machine unique profiles, provide critical part ID and marking, and even set and drive studs.



QUICK-CHANGE TAPPING SYSTEMS FOR CNC MACHINES

Bilz is the global leader in precision quick-change tapping systems for CNC machine tools, offering a broad range of choices with full tension/compression compensation as well as self-reversing tapping attachments. Bilz CNC tapping solutions covers a full-range of applications from rigid tapping, where the Synchro Chuck offers improved tool life and thread quality, through high-speed tapping at speeds up to 4,000 RPM using a tool-changer compatible gear attachment (GNCK) with integral reversing capability. Bilz tapping systems are available in all commonly used machine tool spindle styles including HSK, V-Flange style (BT or CAT), DIN (SK or AD) and various straight shank configurations.



Rigid Tapping Holders – Synchro Chuck

- For rigid tapping on CNC machine tools
- Compensates for synchronization errors to extend tap life and to improve thread quality
- For high-speed steel and carbide taps
- Precision collet with coolant through tool options



Rigid Tapping Holders – WF

- Basic quick-change tap holders for use on CNC machine tools with rigid feed capability
- Various shank options available, integral (ACME, B-taper, Morse taper, HSK, straight, and TR) and modular (CAT, MAS-BT)
- Thru-coolant up to 50 bar/ 725 psi



Compensating Tapping Holders – WFLC & WFLK

- Length compensating quick-change holders available with tension-only or tension/compression feature that compensates for differences between spindle speed, feed rate, and tap pitch.
- Unique ball placement for superior length compensation
- Available integral “hard-start” mechanism adjusts cutting pressure to ensure positive start of tapping cycle
- Various shank options available, integral (ACME, B-taper, Morse taper, HSK, straight, and TR) and modular (CAT, MAS-BT)
- Thru-coolant to 50 bar/750 psi available (WFLC-IKP)



Self-Reversing Tapping Attachments GNCN and GNCK

- Tapping attachment with integral reversing gear
- Tapping speeds up to 4,000 RPM
- For CNC machines with automatic toolchangers
- Thru-coolant to 50 bar/750 psi (GNCK)

Bilz modular, quick-change tap adapters provide the ultimate in machining flexibility. They are available in a full-range of sizes, styles, and configurations to handle virtually any application requirement on manual, CNC, or special machine tools at any volume level. Bilz offers solid, length-adjustable, close-center, and thru-coolant capable tap adapters in all standard configurations meeting ANSI, DIN, ISO, and JIS specifications. Bilz tap adapters are precision manufactured to ensure long tap life as well as optimum performance and low life-cycle cost.



Positive Drive – WE

- Basic non-torque quick-change tap adapter
- Suitable for use with thru-coolant or coolant-around taps (KP-style)
- Interchangeable with other brands of tap adapters



Positive Drive Length-Adjustable – WEN

- Length-adjustable, non-torque design allows tap length to be preset
- Excellent for close-center applications
- Suitable for use with thru-coolant or coolant-around taps (KP-option)
- Available in extended lengths, and with optional thru-coolant



Torque-Control – WES

- Integral torque clutch prevents tap breakage
- Left-hand tap clutches available
- Suitable for use with thru-coolant or coolant-around taps (KP-option)



Torque-Control Length-Adjustable – WESN

- Length-adjustable design allows tap length to be preset
- Integral, adjustable torque clutch prevents tap breakage
- Suitable for use with thru-coolant or coolant-around taps (KP-option)
- Available in extended lengths, and with optional thru-coolant



Thru-Coolant Collet Type – WE IKP-ESX







- Ideal for carbide taps and thru-coolant tapping applications
- Available in single-angle (ER) -16, -20, -25, -32 and -40 collet sizes







Reducing Adapter – WRE

- Allows the use of smaller series adapters in larger tapping chucks
- Reduced cost for smaller size tapping



















CONTENTS

Legend	9		
	Quick Change Tapping Systems Introduction	10-11	
<u>WF Rigid CAT V-Flange Coolant Through</u>		<u>12</u>	
<u>WF Rigid BT Flange Coolant Through</u>		<u>12</u>	
<u>WF Rigid Straight Shank Coolant Through</u>		<u>13</u>	
<u>WFLK Tension/Compression CAT V-Flange</u>		<u>14</u>	
<u>WFLK Tension Only CAT V-Flange</u>		<u>14</u>	
<u>WFLK Tension/Compression BT Flange</u>		<u>15</u>	
<u>WFLK Tension Only BT Flange</u>		<u>15</u>	
<u>WFLK Tension/Compression Straight Shank</u>		<u>16</u>	
<u>WFLK Tension Only Straight Shank</u>		<u>16</u>	
<u>WFLC Tension/Compression Straight Shank Coolant Through</u>		<u>16</u>	
<u>WFP Parallel Float CAT V-Flange</u>		<u>17</u>	
<u>WFP Parallel Float BT Flange</u>		<u>17</u>	
<u>WFP Parallel Float Straight Shank</u>		<u>17</u>	
<u>WFLC Tension/Compression HSK Shank</u>		<u>18</u>	
<u>WFLC Tension Only HSK Shank</u>		<u>18</u>	
<u>WFLC Tension/Compression HSK Shank Coolant Through</u>		<u>19</u>	
<u>WFLC Tension Only HSK Shank Coolant Through</u>		<u>19</u>	
	WE/WER ANSI Adapter	20	
<u>WE/WER-KP ANSI Slotted Adapter</u>		<u>21</u>	
<u>WE/WE-KP DIN Adapter</u>		<u>22</u>	
<u>Tap Shank and Square Dimensional Chart</u>		<u>23</u>	
	WES/WESR ANSI Torque Control Adapter	24	
<u>WES DIN Torque Control Adapter</u>		<u>25</u>	
	WEN/WEN-KP ANSI Adjustable Length Adapter	26	
<u>WE/WEN-KP DIN Adjustable Length Adapter</u>		<u>27</u>	
	WEN/WEN-KP/WEN-IKP Extended Length Adapter	28	
	WE-ER Collet Adapter	29	
<u>WEK Extended Range Adapter</u>		<u>29</u>	
<u>WESK Extended Range Torque Control Adapter</u>		<u>29</u>	
<u>WRE Reducing Adapter</u>		<u>29</u>	
	Automotive Shank Tap Chucks	30	
<u>WF Rigid ACME Shank</u>		<u>30</u>	
<u>WF Rigid TR (DIN) Shank</u>		<u>30</u>	
<u>WF Rigid Morse Taper Shank</u>		<u>30</u>	
<u>WF Rigid B Taper</u>		<u>31</u>	
<u>WFLK Tension/Compression Morse Taper Shank</u>		<u>31</u>	
<u>WFLK Tension/Compression ACME Shank</u>		<u>32</u>	
<u>WFLK Tension/Compression TR Shank</u>		<u>32</u>	
<u>WFP Parallel Float ACME Shank</u>		<u>33</u>	

WFP Parallel Float TR (DIN) Shank	33
WFP Parallel Float Morse Taper Shank	33
 ASBA Over Spindle Adapter ANSI/Metric	34
SSM ANSI Quick Change Nut	34
ASBVA Over Spindle Adapter ANSI/Metric	35
SSM DIN Quick Change Nut	35
 SBK Quick Change System	36
SBK Morse Taper Master Holder	36
SELK Tension/Compression Adapter	36
SEK/ER Collet Adapter	37
SEK/B Taper	37
 TA Reversing Tapping Attachment	38–39
 DSPL Tapping Chuck	40
GNCK Reversing Tapping Attachement	41–43

 Synchro Chuck Introduction	44–45
Synchro Chuck HSK Shank	46–47
Synchro Chuck Straight Shank	48
Synchro Chuck V-Flange	48
ER-GB Square Drive Tap Collets	49–50
DS/ER Seal Discs	51
ER Single Angle Collets	52–53
ER Collet Nuts	54
ER Wrenches	55
Synchro Chuck Accessories	56–57
MQL Overview	58–59
Advanced Solutions	60–67
PN-GPK Floating Holder	61
<i>formbore</i> System	62–66
SCF Stud Driver	67
ET Engraving Tool	67
STF Stamping Tool	67
Technical Information	68–75

LEGEND

 Concentricity	 Minimum Quantity Lubrication (MQL) 10 bar	 Screw
 Length Adjustment	 Hard Start	 Collet Nut
 Length Compensation Compression	 Ball Bearing	 Thread Size
 Length Compensation Tension	 Wrench	 10 bar
 Radial Parallel Float	 Sealing Disc	 15 bar
 Safety Clutch	 Collet	 20 bar
		 50 bar

QUICK CHANGE TAPPING

Bilz is the original developer and patent holder for this globally accepted and widely used product. For over 50 years, Bilz has been the leader in the marketplace with this smart solution for high quality tap clamping for most tapping applications.

By using the combination of Bilz tapping adaptors and Bilz quick change tapping chucks, tool changing times can be minimized. On transfer lines and special application machines, where down time costs are high, these efficiencies represent significant savings. CNC machines can also realize the benefits of reduce setup time and tool change time with the Bilz Quick Change tapping system.

The adaptors are designed for optimum efficiency. Removal and replacement in the chuck is rapid and the location and locking of the tap in the adaptor is simple and effective.



VIEW
THE
WEBSITE



Quick Change Adaptors for Tapping and Thread Forming

By using the combination of Bilz tapping adaptors and Bilz quick change tapping chucks, tool changing times can be minimized. On transfer lines and special application machines where down time costs are high, these efficiencies represent significant savings. The adaptors are designed for optimum efficiency. Removal and replacement in the chuck is rapid and the location and locking of the tap in the adaptor is simple and effective.

In all cases the drive of the tap is realized by the square. The tap shank is held in position by a quick locking mechanism. Adaptors with length adjustment are available for setting off the machine, extended length adaptors are available for areas of difficult access, adjustable safety clutch adaptor, to prevent tap breakage. In all cases, a dedicated adaptor is required for each combination of tap shank and square.

Adaptors for other applications, such as those for accepting collets, and dies for external threads or for increased shank diameters, and reducing adaptors complete this product family.



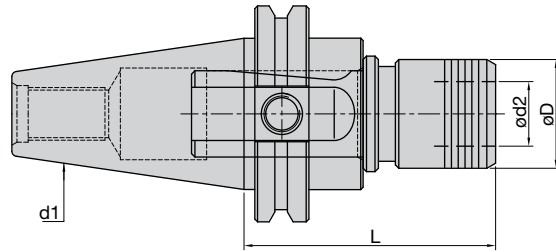

WF – CAT V-Flange

Catalog No.	Description	Shank (d ₁)	Coolant Fed	Dimensions					
				Size (d ₂)	Inch Tap Range	Metric Tap Range	Pipe Tap Range	d	l
117011	WF 1 IKP M/CAT40	CAT40	YES	1	#0-9/16	M3-M12	1/8	1.26	2.92
117012	WF 1 IKP M/CAT50	CAT50	YES	1	#0-9/16	M3-M12	1/8	1.26	2.92
117021	WF 2 IKP M/CAT40	CAT40	YES	2	1/4-7/8	M8-M20	1/8-1/2	1.97	3.50
117022	WF 2 IKP M/CAT50	CAT50	YES	2	1/4-7/8	M8-M20	1/8-1/2	1.97	3.50
117032	WF 3 IKP M/CAT50	CAT50	YES	3	13/16-1-3/8	M14-M33	1/2-1"	2.81	4.81

Note: Coolant Thru @ 50 BAR/725 PSI

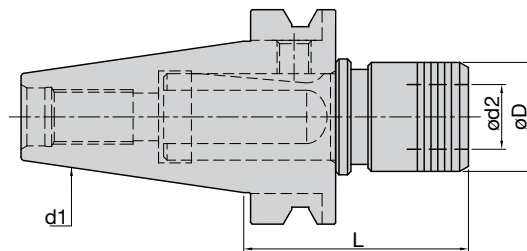

WF – BT

Catalog No.	Description	Shank (d ₁)	Coolant Fed	Dimensions					
				Size (d ₂)	Inch Tap Range	Metric Tap Range	Pipe Tap Range	d	l
11700532	WF 1/BT30	BT30	NO	1	#0-9/16	M3-M12	1/8	1.26	2.44
117014	WF 1 IKP M/BT40	BT40	YES	1	#0-9/16	M3-M12	1/8	1.26	2.60
117015	WF 1 IKP M/BT50	BT50	YES	1	#0-9/16	M3-M12	1/8	1.26	3.33
117024	WF 2 IKP M/BT40	BT40	YES	2	1/4-7/8	M8-M20	1/8-1/2	1.97	3.19
117025	WF 2 IKP M/BT50	BT50	YES	2	1/4-7/8	M8-M20	1/8-1/2	1.97	4.00
117035	WF 3 IKP M/BT50	BT50	YES	3	13/16-1-3/8	M14-M33	1/2-1"	2.81	5.31

Note: Coolant Thru @ 50 BAR/725 PSI

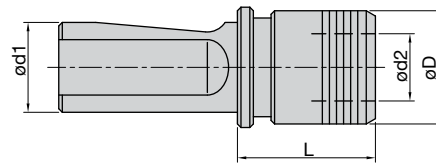

WF – Straight Shank									
Catalog No.	Description	Shank d ₁	Coolant Fed	Dimensions					
				Adapter Size d ₂	Inch Tap Range	Metric Tap Range	Pipe Tap Range	d	l
Inch Shank									
11700623	WF 1 IKP M/ 3/4	0.75	YES	1	#0-9/16	M3-M12	1/8	1.26	1.53
11700624	WF 1 IKP M/1	1.0	YES	1	#0-9/16	M3-M12	1/8	1.26	1.53
11700625	WF 2 IKP M/1	1.0	YES	2	1/4-7/8	M8-M20	1/8-1/2	1.97	2.13
11700626	WF 3 IKP M/1.5	1.5	YES	3	13/16-1-3/8	M14-M33	1/2-1"	2.81	3.44
Metric Shank									
11700702	WF 1 IKP MS/25	25MM	YES	1	#0-9/16	M3-M12	1/8	1.26	1.53
11700703	WF 2 IKP MS/25	25MM	YES	2	1/4-7/8	M8-M20	1/8-1/2	1.97	2.13
11700704	WF 3 IKP MS/32	32MM	YES	3	13/16-1-3/8	M14-M33	1/2-1"	2.81	3.44

Note: Coolant Thru @ 50 BAR/725 PSI

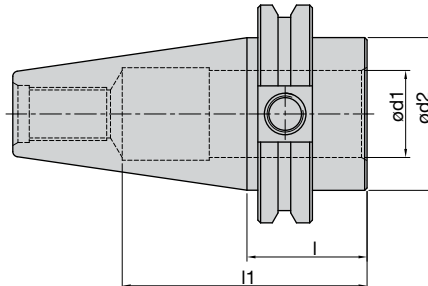
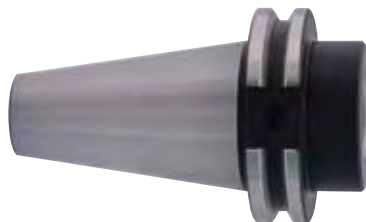

V-Flange Toolholder Modular						
SAP No.	Catalog No.	Description	Dimensions			
			d ₁	d ₂	l ₁	l
12934216	12934216	CAT40 w/1 Bore	1.0	45	68.5	1.375
12934218	12934218	CAT50 w/1 Bore	1.0	70	84.5	1.375
12934219	12934219	CAT50 w/1.5 Bore	1.5	70	84.5	1.375
12934221	12934221	BT40 w/1 Bore	1.0	45	68.5	1.062
12934223	12934223	BT50 w/1 Bore	1.0	70	84.5	1.875
12934880	12934880	BT50 w/1.5 Bore	1.5	70	84.5	1.875
99831412	*WA25/A126/B40	40 Taper 25mm Bore	25mm	50	54	1.378
98831533	*WA25/A126/B50	50 Taper 25mm Bore	25mm	70	54	1.378

*For coolant thru the flange, use with MS25 shank tools.

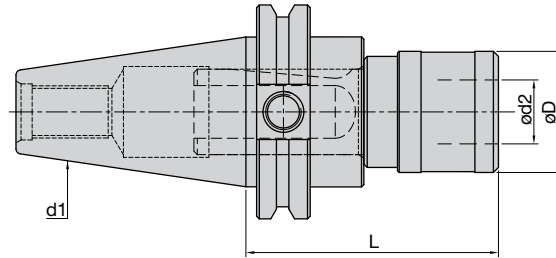

WFLK – CAT V-Flange											
Catalog No.	Description	Shank (d1)	Coolant Fed	Dimensions							
				Adapter Size (d2)	Inch Tap Range	Metric Tap Range	Pipe Tap Range	Comp. (inch)	Tension (inch)	D	L
Tension & Compression Chucks											
100001	WFLK 013 BM/CAT40	CAT40	NO	0	#0-5/16	M3-M10	NA	0.26	0.26	1.02	2.96
100003	WFLK 013 BM/CAT50	CAT50	NO	0	#0-5/16	M3-M10	NA	0.30	0.30	1.02	2.96
100011	WFLK 115 BM/CAT40	CAT40	NO	1	#0-9/16	M3-M12	1/8	0.30	0.30	1.42	2.96
100013	WFLK 115 BM/CAT50	CAT50	NO	1	#0-9/16	M3-M12	1/8	0.49	0.49	1.42	2.96
100021	WFLK 225 BM/CAT40	CAT40	NO	2	1/4-7/8	M8-M20	1/8-1/2	0.49	0.49	2.09	3.86
100023	WFLK 225 BM/CAT50	CAT50	NO	2	1/4-7/8	M8-M20	1/8-1/2	0.79	0.79	2.09	3.86
100030	WFLK 340 BM/CAT50	CAT50	NO	3	13/16-1-3/8	M14-M33	1/2-1"	0.79	0.79	3.07	5.16
100040	WFLK 445 BM/CAT50	CAT50	NO	4	1"-1-7/8	M22-M45	3/4-1-7/8	0.89	0.89	6.41	5.79
Tension Only Chucks											
100011-0	WFLK 115-0 BM/CAT40	CAT40	NO	1	#0-9/16	M3-M12	1/8	0	0.59	1.417	2.66
100013-0	WFLK 115-0 BM/CAT50	CAT50	NO	1	#0-9/16	M3-M12	1/8	0	0.59	1.417	2.66
100021-0	WFLK 225-0 BM/CAT40	CAT40	NO	2	1/4-7/8	M8-M20	1/8-1/2	0	0.98	2.087	3.37
100023-0	WFLK 225-0 BM/CAT50	CAT50	NO	2	1/4-7/8	M8-M20	1/8-1/2	0	0.98	2.087	3.37
100030-0	WFLK 340-0 BM/CAT50	CAT50	NO	3	13/16-1-3/8	M14-M33	1/2-1"	0	1.38	3.071	4.37

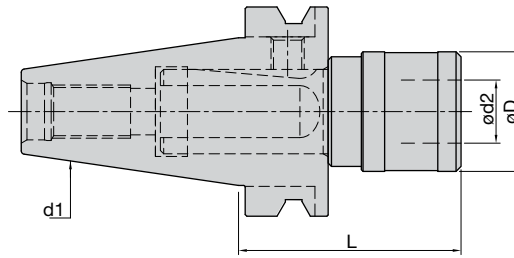

WFLK – BT Flange											
Catalog No.	Description	Shank (d1)	Coolant Fed	Dimensions							
				Adapter Size (d2)	Inch Tap Range	Metric Tap Range	Pipe Tap Range	Comp. (inch)	Tension (inch)	D	L
Tension & Compression Chucks											
100005	WFLK 013 BM/BT40	BT40	NO	0	#0-5/16	M3-M10	NA	0.26	0.26	1.024	2.65
100007	WFLK 013 BM/BT50	BT50	NO	0	#0-5/16	M3-M10	NA	0.30	0.30	1.024	3.46
12418146	WFLK 115 B/BT30	BT30	NO	1	#0-9/16	M3-M12	1/8	0.30	0.30	1.417	2.60
100015	WFLK 115 BM/BT40	BT40	NO	1	#0-9/16	M3-M12	1/8	0.30	0.30	1.417	2.65
100017	WFLK 115 BM/BT50	BT50	NO	1	#0-9/16	M3-M12	1/8	0.49	0.49	1.417	3.46
100024	WFLK 225 BM/BT40	BT40	NO	2	1/4-7/8	M8-M20	1/8-1/2	0.49	0.49	2.087	3.55
100026	WFLK 225 BM/BT50	BT50	NO	2	1/4-7/8	M8-M20	1/8-1/2	0.79	0.79	2.087	4.36
100032	WFLK 340 BM/BT50	BT50	NO	3	13/16-1-3/8	M14-M33	1/2-1"	0.79	0.79	3.071	5.66
100042	WFLK 445 BM/BT50	BT50	NO	4	1"-1-7/8	M22-M45	3/4-1-7/8	0.89	0.89	6.41	6.29
Tension Only Chucks											
100015-0	WFLK 115-0 BM/BT40	BT40	NO	1	#0-9/16	M3-M12	1/8	0	0.59	1.417	2.36
100017-0	WFLK 115-0 BM/BT50	BT50	NO	1	#0-9/16	M3-M12	1/8	0	0.59	1.417	3.16
100024-0	WFLK 225-0 BM/BT40	BT40	NO	2	1/4-7/8	M8-M20	1/8-1/2	0	0.98	2.087	3.06
100026-0	WFLK 225-0 BM/BT50	BT50	NO	2	1/4-7/8	M8-M20	1/8-1/2	0	0.98	2.087	3.87
100032-0	WFLK 340-0 BM/BT50	BT50	NO	3	13/16-1-3/8	M14-M33	1/2-1"	0	1.38	3.071	4.87

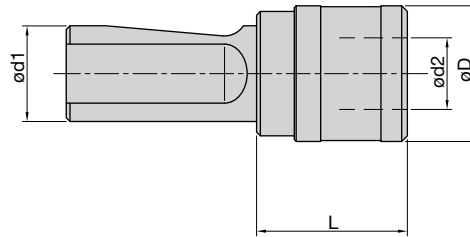

WFLK – Straight Shank – Non-Coolant											
Catalog No.	Description	Shank (d1)	Coolant Fed	Dimensions							
				Adapter Size (d2)	Inch Tap Range	Metric Tap Range	Pipe Tap Range	Comp. (inch)	Tension (inch)	D	L
Tension & Compression Chucks											
12008082	WFLK 013 BM/1	1.0	NO	0	#0-5/16	M3-M10	NA	0.26	0.26	1.024	1.58
12018209	WFLK 115 BM/ 3/4	0.75	NO	1	#0-9/16	M3-M12	1/8	0.3	0.3	1.417	1.58
12018298	WFLK 115 BM/1	1.0	NO	1	#0-9/16	M3-M12	1/8	0.3	0.3	1.417	1.58
12028377	WFLK 225 BM/1	1.0	NO	2	1/4-7/8	M8-M20	1/8-1/2	0.49	0.49	2.087	2.48
12038247	WFLK 340 BM/1.5	1.5	NO	3	13/16-1-3/8	M14-M33	1/2-1"	0.79	0.79	3.071	3.78
12048164	WFLK 445 BM/1.5	1.5	NO	4	1"-1-7/8	M22-M45	3/4-1-7/8	0.89	0.89	3.78	4.41
Tension Only Chucks											
12018486	WFLK 115-0 BM/1	1.0	NO	1	#0-9/16	M3-M12	1/8	0.3	0.3	1.417	1.29
12028429	WFLK 225-0 BM/1	1.0	NO	2	1/4-7/8	M8-M20	1/8-1/2	0.49	0.49	2.087	1.99
12038353	WFLK 340-0 BM/1.5	1.5	NO	3	13/16-1-3/8	M14-M33	1/2-1"	0.79	0.79	3.071	3.09

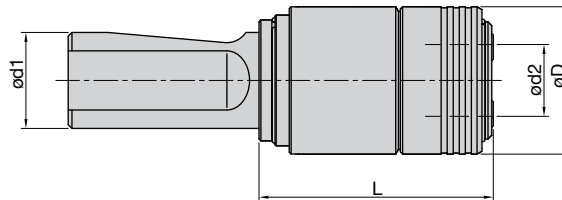

WFLC – Straight Shank – Coolant Through											
Catalog No.	Description	Shank (d1)	Coolant Fed	Dimensions							
				Adapter Size (d2)	Inch Tap Range	Metric Tap Range	Pipe Tap Range	Comp. (inch)	Tension (inch)	D	L
Tension & Compression Chucks											
38218003	WFLC 115 IKP M/1	1.0	YES	1	#0-9/16	M3-M12	1/8	0.3	0.3	1.417	2.441
38228002	WFLC 220 IKP M/1	1.0	YES	2	1/4-7/8	M8-M20	1/8-1/2	0.49	0.49	2.087	3.858
38038027	WFLC 335 IKP M/1.5	1.5	YES	3	13/16-1-3/8	M14-M33	1/2-1"	0.79	0.79	3.071	5.787
38248002	WFLC 440 IKP M/1.5	1.5	YES	4	1-1-7/8	M22-M45	3/4-1-7/8	0.89	0.89	3.78	4.41
38218002	WFLC 115-IKP/ MS25	25MM	YES	1	#0-9/16	M3-M12	1/8	7.5	7.5	39	62
38228001	WFLC 220-IKP/ MS25	25MM	YES	2	1/4-7/8	M8-M20	1/8-1/2	10	10	60	98
38238001	WFLC 335-IKP/ MS32	32MM	YES	3	13/16-1-3/8	M14-M33	1/2-1"	17.5	17.5	86	147

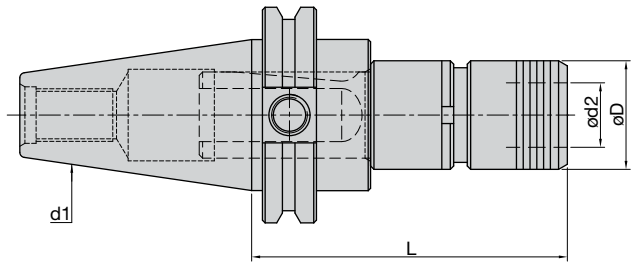

WFP – CAT V-Flange				Dimensions						
Catalog No.	Description	Shank (d1)	Coolant Fed	Adapter Size (d2)	Inch Tap Range	Metric Tap Range	Pipe Tap Range	Float	D	L
112111	WFP 1 M/CAT40	CAT40	NO	1	#0-9/16	M3-M12	1/8	0.02	1.26	3.66
112112	WFP 1 M/CAT50	CAT50	NO	1	#0-9/16	M3-M12	1/8	0.02	1.26	3.66
112221	WFP 2 M/CAT40	CAT40	NO	2	1/4-7/8	M8-M20	1/8-1/2	0.04	1.97	4.69
112222	WFP 2 M/CAT50	CAT50	NO	2	1/4-7/8	M8-M20	1/8-1/2	0.04	1.97	4.69

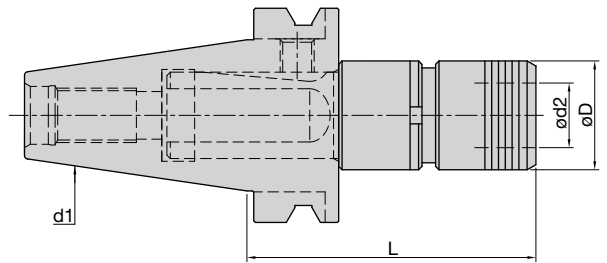

WFP – BT				Dimensions						
Catalog No.	Description	Shank (d1)	Coolant Fed	Adapter Size (d2)	Inch Tap Range	Metric Tap Range	Pipe Tap Range	Float	D	L
112114	WFP 1 M/BT40	BT40	NO	1	#0-9/16	M3-M12	1/8	0.02	1.26	3.34
112115	WFP 1 M/BT50	BT50	NO	1	#0-9/16	M3-M12	1/8	0.02	1.26	4.16
112224	WFP 2 M/BT40	BT40	NO	2	1/4-7/8	M8-M20	1/8-1/2	0.04	1.97	4.37
112225	WFP 2 M/BT50	BT50	NO	2	1/4-7/8	M8-M20	1/8-1/2	0.04	1.97	5.19

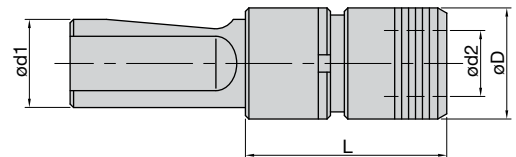

WFP – Straight Shank				Dimensions						
Catalog No.	Description	Shank (d1)	Coolant Fed	Adapter Size (d2)	Inch Tap Range	Metric Tap Range	Pipe Tap Range	Float	D	L
11212540	WFP 1 M/1"	1.0	NO	1	#0-9/16	M3-M12	1/8	0.02	1.26	2.28
11222540	WFP 2 M/1"	1.0	NO	2	1/4-7/8	M8-M20	1/8-1/2	0.04	1.97	3.31

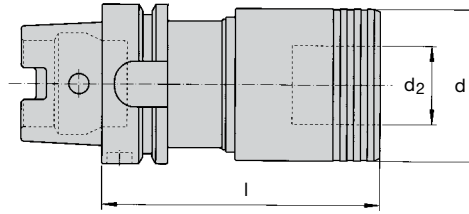

WFLC – HSK-A – Non-Coolant											
SAP No.	Catalog No.	Designation	Adapter Size	Dimensions (mm)							
				Tap Range			Length Compensation		d	d ₂	l
				Metric	Inch	Pipe	Comp.	Tens.			
Tension & Compression											
6728133	38018200	WFLC 115/HSK-A50	1	M3-M14	#0-9/16	1/8	7.5	7.5	39.0	19.0	72.0
6727989	38018053	WFLC 115/HSK-A63	1	M3-M14	#0-9/16	1/8	7.5	7.5	39.0	19.0	72.0
6728062	38018128	WFLC 115/HSK-A80	1	M3-M14	#0-9/16	1/8	7.5	7.5	39.0	19.0	75.0
6728020	38018084	WFLC 115/HSK-A100	1	M3-M14	#0-9/16	1/8	7.5	7.5	39.0	19.0	80.0
6728386	38028174	WFLC 220/HSK-A50	2	M8-M24	5/16-7/8	1/4-1/2	10.0	10.0	60.0	31.0	110.0
6728293	38028075	WFLC 220/HSK-A63	2	M8-M24	5/16-7/8	1/4-1/2	10.0	10.0	60.0	31.0	110.0
6728335	38028117	WFLC 220/HSK-A80	2	M8-M24	5/16-7/8	1/4-1/2	10.0	10.0	60.0	31.0	95.0
6728286	38028068	WFLC 220/HSK-A100	2	M8-M24	5/16-7/8	1/4-1/2	10.0	10.0	60.0	31.0	100.0
6728463	38038029	WFLC 335/HSK-A63	3	M14-M36	13/16-1-3/8	3/8-1"	17.5	17.5	86.0	48.0	141.0
6728469	38038036	WFLC 335/HSK-A100	3	M14-M36	13/16-1-3/8	3/8-1"	17.5	17.5	86.0	48.0	144.0
Tension Only											
6728083	38018149	WFLC 115-0/HSK-A50	1	M3-M14	#0-9/16	1/8	0.0	12.5	39.0	19.0	64.5
6728015	38018079	WFLC 115-0/HSK-A63	1	M3-M14	#0-9/16	1/8	0.0	12.5	39.0	19.0	64.5
6728157	38018225	WFLC 115-0/HSK-A80	1	M3-M14	#0-9/16	1/8	0.0	12.5	39.0	19.0	67.5
6728078	38018144	WFLC 115-0/HSK-A100	1	M3-M14	#0-9/16	1/8	0.0	12.5	39.0	19.0	72.5
6728292	38028074	WFLC 220-0/HSK-A63	2	M8-M24	5/16-7/8	1/4-1/2	0.0	16.5	60.0	31.0	100.0
6728403	38028192	WFLC 220-0/HSK-A80	2	M8-M24	5/16-7/8	1/4-1/2	0.0	16.5	60.0	31.0	85.0
6728284	38028066	WFLC 220-0/HSK-A100	2	M8-M24	5/16-7/8	1/4-1/2	0.0	16.5	60.0	31.0	90.0
6728474	38038041	WFLC 335-0/HSK-A63	3	M14-M36	13/16-1-3/8	3/8-1"	0.0	35.0	86.0	48.0	123.5
6728533	38038105	WFLC 335-0/HSK-A100	3	M14-M36	13/16-1-3/8	3/8-1"	0.0	35.0	86.0	48.0	126.5

HSK-A32 and A40 also available

NOTE: All WFLC chucks available in HSK-C version

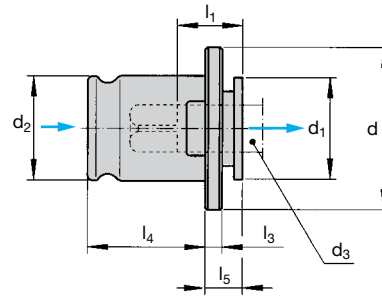

WE/WER – ANSI									
Designation	Tap Size		Dimensions (mm/inch)						
	Inch	Metric	d	d ₁	d ₂	l ₁	l ₃	l ₄	l ₅
WE 0	#0-5/16	M1-M10	22.0 (0.787)	13.0 (.5118)	13.0 (.5118)	15.0 (0.591)	4.0 (.1575)	19.5 (.7677)	7.0 (.2756)
WE 1	#0-9/16	M3-M12	30.0 (1.181)	19.0 (0.748)	19.0 (0.748)	17.0 (0.669)	4.0 (.1575)	21.5 (.8465)	7.0 (.2756)
WE 2	1/4-7/8	M8-M20	48.0 (1.890)	30.0 (1.181)	31.0 (1.220)	30.0 (1.181)	5.0 (.1969)	35.0 (1.378)	11.0 (.4331)
WE 3	13/16-1-3/8	M14-M33	70.0 (2.756)	48.0 (1.890)	48.0 (1.890)	44.0 (1.732)	6.0 (.2362)	55.5 (2.185)	14.0 (.5512)
WER2	1/8-1/2 NPT		48.0 (1.890)	30.0 (1.181)	31.0 (1.220)	21.0 (.827)	5.0 (.1969)	35.0 (1.378)	11.0 (.4331)
WER3	3/8-1" NPT		70.0 (2.756)	48.0 (1.890)	48.0 (1.890)	25.0 (.984)	6.0 (.2362)	55.5 (2.185)	14.0 (.5512)
WER4	1"-1-7/8	M22-M48	92.0 (3.622)	60.0 (2.362)	60.0 (2.362)	46.0 (1.811)	13.0 (.512)	63.0 (2.480)	42.0 (1.654)
WER4	3/4-1-1/2 NPT		92.0 (3.622)	60.0 (2.362)	60.0 (2.362)	46.0 (1.811)	13.0 (.512)	63.0 (2.480)	42.0 (1.654)
Size		Shank Dia.	Square	Catalog No.					
Inch	Metric			WE 0	WE 1	WE 2	WE 3	WER* 4	
Hand Taps									
#0-6	M3	0.141	0.110	29100028	21100019				
#8, 5/32	M4	0.168	0.131	29100041	21100027				
#10, 3/16	M4.5, M5	0.194	0.152	29100052	21100038				
#12, 7/32		0.220	0.165	29100062	21100046				
1/4, #14	M6, M6.5	0.255	0.191	29100077	21100063	22100010			
1/4 small shank	M6, M6.5	0.185	0.138		21100035				
5/16	M7, M8	0.318	0.238	29100101	21100089	22100022			
5/16 small shank	M7, M8	0.240	0.18		21100057				
3/8	M10	0.381	0.286		21100112	22100040			
3/8 small shank	M10	0.275	0.206		21100067				
7/16		0.323	0.242		21100091	22100023			
1/2	M12, M12.5	0.367	0.275		21100105	22100033			
9/16	M14	0.429	0.322		21100119	22100043			
5/8	M16	0.480	0.360			22100058			
11/16	M18	0.542	0.406			22100067			
3/4		0.590	0.442			22100147	23100013		
13/16	M20	0.652	0.489			22100089	23100018		
7/8	M22	0.697	0.523			22100093	23100021		
15/16	M24	0.760	0.570				23100028		
1"	M25	0.800	0.600				23100031	24102033	
1-1/8		0.896	0.672				23100038	24102035	
1-1/4	M30	1.021	0.766				23100045	24102037	
1-3/8	M33	1.108	0.831				23100053	24102001	
1-1/2	M36	1.233	0.925					24102004	
1-5/8	M39	1.305	0.979					24102005	
1-3/4	M42	1.430	1.072					24102007	
1-7/8		1.519	1.139					24102009	
Size		Shank Dia.	Square	Catalog No.					
Inch	NPT			WE 1	WER* 2	WER* 3	WER* 4		
Pipe Taps									
1/8 NPT	SMALL SHANK	0.313	0.234		21100081				
1/8 NPT	LARGE SHANK	0.437	0.328		21100124	22102016			
1/4 NPT	1/4 NPT	0.562	0.421			22102002			
3/8 NPT	3/8 NPT	0.700	0.531			22102005	23102035		
1/2 NPT	1/2 NPT	0.688	0.515			22102004	23102049		
3/4 NPT	3/4 NPT	0.906	0.679				23102004	24102025	
1" NPT	1" NPT	1.125	0.843				23102007	24102043	
1-1/4" NPT	1-1/4" NPT	1.313	0.984					24102006	
1-1/2" NPT	1-1/2" NPT	1.500	1.125					24102008	

*WER are non-coolant through

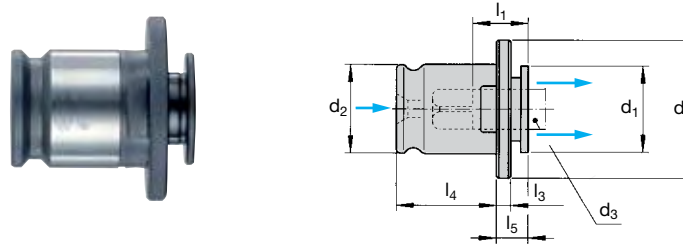

WE KP – ANSI									
Designation	Tap Size		Dimensions (mm/inch)						
	Inch	Metric	d	d ₁	d ₂	l ₁	l ₃	l ₄	l ₅
WE 1 KP	#0-9/16	M3-M12	30.0 (1.181)	19.0 (0.748)	19.0 (0.748)	17.0 (0.669)	4.0 (.1575)	21.5 (.8465)	7.0 (.2756)
WE 2 KP	1/4-7/8	M8-M20	48.0 (1.890)	30.0 (1.181)	31.0 (1.220)	30.0 (1.181)	5.0 (.1969)	35.0 (1.378)	11.0 (.4331)
WE 3 KP	13/16-1-3/8	M14-M33	70.0 (2.756)	48.0 (1.890)	48.0 (1.890)	44.0 (1.732)	6.0 (.2362)	55.5 (2.185)	14.0 (.5512)
WER2 KP	1/8-1/2 NPT		48.0 (1.890)	30.0 (1.181)	31.0 (1.220)	21.0 (.827)	5.0 (.1969)	35.0 (1.378)	11.0 (.4331)
WER3 KP	3/8-1" NPT		70.0 (2.756)	48.0 (1.890)	48.0 (1.890)	25.0 (.984)	6.0 (.2362)	55.5 (2.185)	14.0 (.5512)
Size		Shank Dia.	Square	Catalog No.					
Inch	Metric			WE 1 KP	WE 2 KP	WE 3 KP			
Hand Taps									
#0-6	M3	0.141	0.110	21184032					
#8, 5/32	M4	0.168	0.131	21184031					
#10, 3/16	M4.5, M5	0.194	0.152	21184029					
#12, 7/32	#12	0.220	0.165	21184036					
1/4, #14	M6, M6.5	0.255	0.191	21184019					
5/16	M7, M8	0.318	0.238	21184020	22167430				
3/8	M10	0.381	0.286	21184021	22167424				
7/16		0.323	0.242	21184022	22167433				
1/2	M12, M12.5	0.367	0.275	21184023	22167418				
9/16	M14	0.429	0.322	21184024	22167428				
5/8	M16	0.480	0.360		22167419				
11/16	M18	0.542	0.406		22167438				
3/4		0.590	0.442		22167420				
13/16	M20	0.652	0.489		22167436	23156430			
7/8	M22	0.697	0.523		22167434	23156419			
15/16	M24	0.760	0.570			23156429			
1"	M25	0.800	0.600			23156420			
1-1/8		0.896	0.672			23156436			
1-1/4	M30	1.021	0.766			23156434			
1-3/8	M33	1.108	0.831			23156422			
Size		Shank Dia.	Square	Catalog No.					
Inch	NPT			WE 1 KP	WER 2 KP	WER 3 KP			
Pipe Taps									
1/8 NPT	SMALL SHANK	0.3125	0.234	21184035					
1/8 NPT	LARGE SHANK	0.437	0.328	21184030					
1/4 NPT	1/4 NPT	0.562	0.421		22185402				
3/8 NPT	3/8 NPT	0.7	0.531		22185405	23157435			
1/2 NPT	1/2 NPT	0.6875	0.515		22185404	23157436			
3/4 NPT	3/4 NPT	0.906	0.679			23157404			
1" NPT	1" NPT	1.125	0.843			23157407			

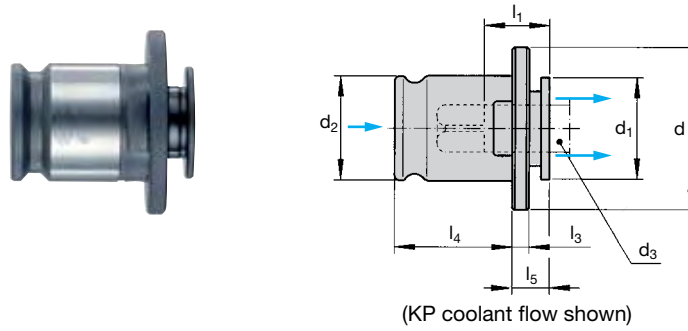

WE / WE KP – DIN 371/376											
Tap Size			Dimensions (mm/inch)								
Designation	Inch	Metric	d	d ₁	d ₂	l ₁	l ₃	l ₄	l ₅		
WE 0	#0-5/16	M1-M10	22.0 (0.787)	13.0 (.5118)	13.0 (.5118)	15.0 (0.591)	4.0 (.1575)	19.5 (.7677)	7.0 (.2756)		
WE 1 / WE 1 KP	#0-9/16	M3-M12	30.0 (1.181)	19.0 (0.748)	19.0 (0.748)	17.0 (0.669)	4.0 (.1575)	21.5 (.8465)	7.0 (.2756)		
WE 2 / WE 2 KP	1/4-7/8	M8-M20	48.0 (1.890)	30.0 (1.181)	31.0 (1.220)	30.0 (1.181)	5.0 (.1969)	35.0 (1.378)	11.0 (.4331)		
WE 3 / WE 3 KP	13/16-1-3/8	M14-M33	70.0 (2.756)	48.0 (1.890)	48.0 (1.890)	44.0 (1.732)	6.0 (.2362)	55.5 (2.185)	14.0 (.5512)		
WE 4	1"-1-7/8	M22-M48	92.0 (3.622)	60.0 (2.362)	60.0 (2.362)	71.0 (2.799)	13.0 (0.512)	63.0 (2.480)	42.0 (1.654)		
Size	Shank Dia.		DIN Spec	Catalog No.							
Metric		Square		WE 0	WE 1	WE 1 KP	WE 2	WE 2 KP	WE 3	WE 3 KP	WE 4
DIN-371											
M3	3.5 (0.138)	2.7 (0.106)	DIN 371	29100025	21100017	21184013					
M4	4.5 (0.177)	3.4 (0.134)	DIN 371	29100044	21100030	21184010					
M5	6.0 (0.236)	4.9 (0.193)	DIN 371	29100067	21100054	21184011					
M6	6.0 (0.236)	4.9 (0.193)	DIN 371	29100067	21100054	21184011	22100004	22167421			
M7	7.0 (0.276)	5.5 (0.217)	DIN 371	29100082	21100068	21184009	22100011	22167423			
M8	8.0 (0.315)	6.2 (0.244)	DIN 371	29100087	21100086	21184001	22100020	22167402			
M9	9.0 (0.354)	7.0 (0.276)	DIN 371		21100099	21184003	22100031	22167404			
M10	10.0 (0.394)	8.0 (0.315)	DIN 371		21100115	21184005	22100041	22167406			
DIN-376											
M8	6.0 (0.236)	4.9 (0.193)	DIN 376	29100067	21100054	21184011	22100004	22167421			
M10	7.0 (0.276)	5.5 (0.217)	DIN 376	29100082	21100068	21184009	22100011	22167423			
M12	9.0 (0.354)	7.0 (0.276)	DIN 376		21100099	21184003	22100031	22167404			
M14	11.0 (0.433)	9.0 (0.354)	DIN 376		21100123	21184006	22100046	22167407	23100004	23156402	
M16	12.0 (0.472)	9.0 (0.354)	DIN 376				22100056	22167409	23100006	23156410	
M18	14.0 (0.551)	11.0 (0.433)	DIN 376				22100069	22167411	23100011	23156403	
M20	16.0 (0.630)	12.0 (0.472)	DIN 376				22100084	22167413	23100016	23156413	
M22	18.0 (0.709)	14.5 (0.571)	DIN 376						23100024	23156401	24100002
M24	18.0 (0.709)	14.5 (0.571)	DIN 376						23100024	23156401	24100002
M27	20.0 (0.787)	16.0 (0.630)	DIN 376						23100030	23156406	24100004
M30	22.0 (0.866)	18.0 (0.709)	DIN 376						23100035	23156404	24100006
M33	25.0 (0.984)	20.0 (0.787)	DIN 376						23100044	23156407	24100009
M36	28.0 (1.102)	22.0 (0.866)	DIN 376								24100012
M39	32.0 (1.260)	24.0 (0.945)	DIN 376								24100017
M42	32.0 (1.260)	24.0 (0.945)	DIN 376								24100017
M45	36.0 (1.417)	29.0 (1.142)	DIN 376								24100020
M48	36.0 (1.417)	29.0 (1.142)	DIN 376								24100020

Also available in JIS and ISO

NOTE: WE style also suitable for taps with axial coolant hole

WE KP style delivers coolant around tap shank for noncoolant taps

ANSI Shank							Metric Shank												
metric thread, ANSI shank	Tap #	fract. Dia	inch shank dia.	inch square	dia [mm]	square [mm]	inch shank dia.	inch square	dia [mm]	square [mm]	DIN352 hand tap short	DIN353 inch	DIN371 strong shank	DIN376 DIN374 normal +fine	DIN2182 normal inch	DIN2183 out of range inch	ISO 529	JIS	JIS inch
M1.6	0		0.141	0.110	3.58	2.79	0.098	0.083	2.5	2.1	M1		M1	M3.5	1/16"	1/16"			
M1.8	1		0.141	0.110	3.58	2.79	0.098	0.083	2.5	2.1	M1.1		M1.1						
M2, M2.2	2		0.141	0.110	3.58	2.79	0.098	0.083	2.5	2.1	M1.2		M1.2						
M2.5	3		0.141	0.110	3.58	2.79	0.098	0.083	2.5	2.1	M1.4		M1.4						
	4		0.141	0.110	3.58	2.79	0.098	0.083	2.5	2.1	M1.6		M1.6						
M3, M3.15	5	1/8"	0.141	0.110	3.58	2.79	0.098	0.083	2.5	2.1	M1.8		M1.8						
M3.5	6		0.141	0.110	3.58	2.79	0.110	0.083	2.8	2.1	M2		M2	M4	3/32"	5/32"			
	7		0.168	0.130	4.26	3.3	0.110	0.083	2.8	2.1	M2.2		M2.2						
M4	8	5/32"	0.168	0.130	4.26	3.3	0.110	0.083	2.8	2.1	M2.5		M2.5						
	9		0.194	0.152	4.93	3.86	0.110	0.088	2.8	2.24							M2.5		
M5	10	3/16"	0.194	0.152	4.93	3.86	0.118	0.098	3	2.5								M2.5	#3
	12	7/32"	0.220	0.165	5.59	4.19	0.124	0.098	3.15	2.5							#8		
M6, M6.3	14	1/4"	0.247	0.185	6.27	4.7	0.124	0.110	3.15	2.8							#4		
	16		0.273	0.205	6.93	5.2	0.138	0.106	3.5	2.7	M3		M3	M5	1/8"				
	18		0.299	0.225	7.59	5.71	0.140	0.110	3.55	2.8							#6		
	20		0.325	0.244	8.25	6.2	0.157	0.118	4	3	M3.5		M3.5 #6		7/32"				
		5/32"	0.160	0.122	4.06	3.1	0.157	0.126	4	3.2								M3	#5, #6
		3/16"	0.192	0.149	4.88	3.78	0.177	0.134	4.5	3.4	M4		M4	M6	5/32"	1/4"			
		7/32"	0.223	0.167	5.66	4.24	0.197	0.157	5	4							#10	M4, M5	#8
		1/4"	0.255	0.191	6.48	4.85	0.217	0.177	5.5	4.5								M5, M5.5	#10
		9/32"	0.286	0.214	7.26	5.44	0.220	0.177	5.6	4.5							#12		
M7, M8		5/16"	0.318	0.238	8.08	6.05	0.236	0.177	6	4.5								M6	1/4"-20
		11/32"	0.349	0.262	8.86	6.65	0.236	0.193	6	4.9	M5		M5						
M10		3/8"	0.381	0.286	9.68	7.26	0.236	0.193	6	4.9	M6, M8		M6	M8					
		13/32"	0.323	0.242	8.20	6.15	0.240	0.197	6.1	5								M6	
		7/16"	0.323	0.242	8.20	6.15	0.244	0.197	6.2	5								M8, M7	5/16"-18
		15/32"	0.354	0.265	8.99	6.73	0.248	0.197	6.3	5							1/4"-20		
M12, M12.5		1/2"	0.367	0.275	9.32	6.99	0.276	0.217	7	5.5	M10	G1/8"		M10	1/4"	3/8"		M10, M9	
		17/32"	0.398	0.298	10.11	7.57	0.315	0.236	8	6								M11	1/8"
M14		9/16"	0.429	0.322	10.90	8.18	0.315	0.244	8	6.2					5/16"	7/16"			
		19/32"	0.460	0.345	11.68	8.76	0.315	0.248	8	6.3							5/16"-18		
M16		5/8"	0.480	0.360	12.19	9.14	0.335	0.256	8.5	6.5								M12	
		21/32"	0.511	0.383	12.98	9.73	0.354	0.276	9	7				M12	3/8"	1/2"		M12	
M18		11/16"	0.542	0.406	13.77	10.31	0.394	0.315	10	8			M10						
		23/32"	0.573	0.430	14.55	10.92	0.413	0.315	10.5	8								M14, M15	
		3/4"	0.590	0.442	14.99	11.23	0.433	0.354	11	9	M14	G1/4"		M14		9/16"			1/4"
		25/32"	0.621	0.466	15.77	11.84	0.472	0.354	12	9	M16	G3/8"		M16		5/8"		M14, M15	
M20		13/16"	0.652	0.489	16.56	12.42	0.492	0.394	12.5	10							M16	M16	
		27/32"	0.684	0.513	17.37	13.03	0.512	0.394	13	10								M17	
M22		7/8"	0.697	0.523	17.70	13.28	0.551	0.433	14	11	M18			M18		11/16"		M18	3/8"
							0.551	0.441	14	11.2								M18	
M24		15/16"	0.760	0.570	19.30	14.48	0.591	0.472	15	12								M20	
M25		1"	0.800	0.600	20.32	15.24	0.630	0.472	16	12	M20	G1/2"		M20		13/16"			
M27		1-1/16"	0.862	0.646	21.89	16.41	0.669	0.512	17	13								M22	
		1-1/8"	0.896	0.672	22.76	17.07	0.709	0.551	18	14									1/2"
M30		1-3/16"	0.959	0.719	24.36	18.26	0.709	0.571	18	14.5	M22	G5/8"		M22		7/8"			
		1-1/4"	1.021	0.766	25.93	19.46	0.709	0.571	18	14.5	M24			M24		15/16"			
M33		1-5/16"	1.084	0.813	27.53	20.65	0.748	0.591	19	15								M24, M25	1/2" NPT
		1-3/8"	1.108	0.831	28.14	21.11	0.787	0.591	20	15								M27, M26	
M36		1-7/16"	1.171	0.878	29.74	22.3	0.787	0.630	20	16	M27	G3/4"		M27		1"			
		1-1/2"	1.233	0.925	31.32	23.5	0.827	0.669	21	17								M28	
M39		1-5/8"	1.305	0.979	33.15	24.87	0.866	0.669	22	17								M28	
M42		1-3/4"	1.430	1.072	36.32	27.23	0.866	0.709	22	18	M30	G7/8"		M30		1-1/8"			
		1-7/8"	1.519	1.139	38.58	28.93	0.906	0.669	23	17								M30	3/4"
M48		2"	1.644	1.233	41.76	31.32	0.945	0.748	24	19								M32	3/4" NPT
							0.984	0.748	25	19								M33	
							0.984	0.787	25	20	M33	G1"		M33		1-1/4"			
M6		1/4"	0.255	0.191	6.48	4.85	1.024	0.827	26	21								M35, M34	1"
M8		5/16"	0.318	0.238	8.08	6.04	1.102	0.827	28	21								M36, M38	1" NPT
M10		3/8"	0.381	0.286	9.68	7.26	1.102	0.866	28	22	M36	G1-1/8"		M36		1-3/8"			
		7/16"	0.444	0.333	11.28	8.46	1.102	0.882	28	22.4									
		1/2"	0.504	0.380	12.80	9.65	1.181	0.906	30	23								M39, M40	
		5/8"	0.633	0.475	16.08	12.06	1.260	0.945	32	24	M39	G1-1/4"		M39		1-1/2"			
		3/4"	0.756	0.569	19.20	14.45	1.260	0.945	32	24	M42	G1-1/4"		M42		1-5/8"			
							1.260	1.024	32	26								M42	1-1/4"
							1.378	1.024	35	26								M45	1-3/8"
		1/8" SS	0.313	0.234	7.94	5.94	1.417	1.142	36	29	M45	G1-3/8"		M45		1-3/4"			
		1/8" LS	0.437	0.328	11.11	8.33	1.417	1.142	36	29	M48	G1-1/2"		M48		1-7/8"			
		1/4"	0.563	0.421	14.29	10.69	1.417	1.142	36	29									
		3/8"	0.700	0.531	17.78	13.49	1.417	1.142	36	29									
		1/2"	0.687	0.515	17.46	13.08	1.496	1.142	38	29								M48	1-1/2"
		5/8"	0.813	0.594	20.64	15.09	1.575	1.260	40	32	M52	G2-1/4"		M52		2"			
		3/4"	0.906	0.679	23.02	17.25	1.772	1.378	45	35	M56	G2-1/2"		M56		2-1/4"			
		7/8"	1.094	0.812	27.78	20.62	1.772	1.378	45	35	M60			M60		2-1/2"			
		1"	1.125	0.843	28.57	21.41	1.969	1.535	50	39	M64	G2-3/4"		M64		2-1/2"			
		1-1/4"	1.313	0.984	33.34	24.99	1.969	1.535	50	39									
		1-3/8"	1.108	0.831	28.14	21.11	2.205	1.732	56	44	M68	G3-1/4"		M68		2-3/4"			
		1-1/2"	1.500	1.125	38.10	28.57	2.205	1.732	56	44						3"			

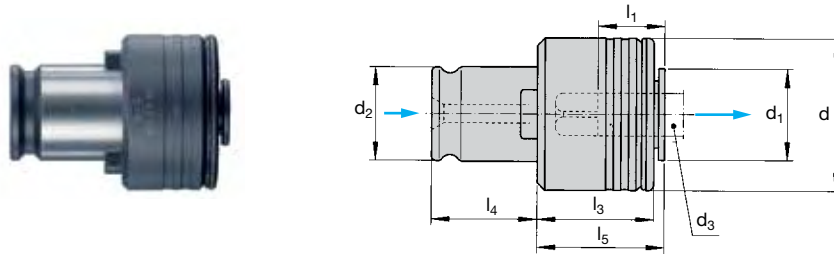

WES / WESR - ANSI									
Designation	Tap Size		Dimensions (mm/inch)						
	Inch	Metric	d	d ₁	d ₂	l ₁	l ₃	l ₄	l ₅
WES 0B	#0-5/16	M1-M10	23.0 (0.906)	13.0 (.5118)	13.0 (.5118)	15.0 (0.591)	20.0 (.7874)	19.5 (.7677)	21.0 (0.827)
WES 1B	#0-9/16	M3-M12	32.0 (1.259)	19.0 (0.748)	19.0 (0.748)	17.0 (0.669)	25.0 (.9843)	21.5 (.8465)	25.0 (0.984)
WES 2B	1/4-7/8	M8-M20	50.0 (1.969)	30.0 (1.181)	31.0 (1.220)	30.0 (1.181)	31.0 (1.220)	35.0 (1.378)	34.0 (1.339)
WES 3B	13/16-1-3/8	M14-M33	72.0 (2.835)	48.0 (1.890)	48.0 (1.890)	44.0 (1.732)	41.0 (1.614)	55.5 (2.185)	45.0 (1.772)
WESR 2B	1/8-1/2 NPT		50.0 (1.969)	30.0 (1.181)	31.0 (1.220)	21.0 (0.827)	31.0 (1.220)	35.0 (1.378)	34.0 (1.339)
WESR 3B	3/8-1" NPT		72.0 (2.835)	48.0 (1.890)	48.0 (1.890)	25.0 (0.984)	41.0 (1.614)	55.5 (2.185)	45.0 (1.772)
WESR 4B	1"-1-7/8	M22-M48	95.0 (3.740)	60.0 (2.362)	60.0 (2.362)	46.0 (1.811)	61.0 (2.402)	63.0 (2.480)	68.0 (2.677)
WESR 4B	3/4-1-1/2 NPT		95.0 (3.740)	60.0 (2.362)	60.0 (2.362)	46.0 (1.811)	61.0 (2.402)	63.0 (2.480)	68.0 (2.677)
Size		Shank Dia.	Square	Catalog No.					
Inch	Metric			WES 0	WES 1	WES 2	WES 3	WESR* 4B	
Hand Taps									
#0-6	M3	0.141	0.11	29200028	21200019				
#8, 5/32	M4	0.168	0.131	29200041	21200027				
#10, 3/16	M4.5, M5	0.194	0.152	29200052	21200038				
#12, 7/32	#12	0.22	0.165	29200062	21200046				
#14, 1/4	M6, M6.5	0.255	0.191	29200077	21200063	22200010			
5/16	M7, M8	0.318	0.238	29200101	21200089	22200022			
3/8	M10	0.381	0.286		21200112	22200040			
7/16	7/16	0.323	0.242		21200091	22200023			
1/2	M12, M12.5	0.367	0.275		21200105	22200033			
9/16	M14	0.429	0.322		21200119	22200043			
5/8	M16	0.48	0.36			22200058			
11/16	M18	0.542	0.406			22200067			
3/4	3/4	0.59	0.442			22200147	23200013		
13/16	M20	0.652	0.489			22200089	23200018		
7/8	M22	0.697	0.523			22200093	23200021		
15/16	M24	0.76	0.57				23200028		
1"	M25	0.8	0.6				23200031	24602033	
1-1/8		0.896	0.672				23200038	24602035	
1-1/4		1.021	0.766				23200045	24602037	
1-3/8		1.108	0.831				23200053	24602001	
1-1/2		1.233	0.925					24602004	
1-5/8		1.305	0.979					24602005	
1-3/4		1.430	1.072					24602007	
1-7/8		1.519	1.139					24602009	
Size		Shank Dia.	Square	Catalog No.					
Inch	Metric			WES 0	WES 1	WESR* 2	WESR* 3	WESR* 4B	
Pipe Taps									
1/8 NPT	SMALL SHANK	0.3125	0.234		21200081				
1/8 NPT	LARGE SHANK	0.437	0.328		21200124	22200048			
1/4 NPT	1/4 NPT	0.562	0.421			22602002			
3/8 NPT	3/8 NPT	0.7	0.531			22602005	23602035		
1/2 NPT	1/2 NPT	0.6875	0.515			22602004	23602036		
3/4 NPT	3/4 NPT	0.906	0.679				23602004	24602025	
1" NPT	1" NPT	1.125	0.843				23602007	24602043	
1-1/4 NPT	1-1/4 NPT	1.313	0.984					24602006	
1-1/2 NPT	1-1/2 NPT	1.500	1.125					24602008	

NOTE: WES style also suitable for taps with axial coolant hole.

*WESR are non-coolant through

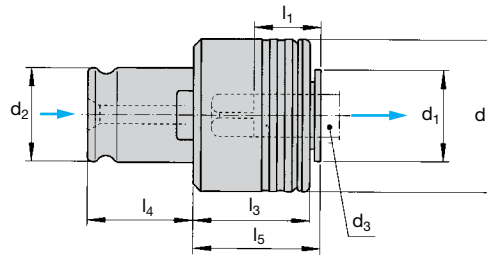

WES – DIN 371/376

Designation	Tap Size		Dimensions (mm/inch)						
	Inch	Metric	d	d ₁	d ₂	l ₁	l ₃	l ₄	l ₅
WES 0B	#0-5/16	M1-M10	23.0 (0.906)	13.0 (0.5118)	13.0 (0.5118)	15.0 (0.591)	20.0 (0.7874)	19.5 (0.7677)	21.0 (0.827)
WES 1B	#0-9/16	M3-M12	32.0 (1.259)	19.0 (0.748)	19.0 (0.748)	17.0 (0.669)	25.0 (0.9843)	21.5 (0.8465)	25.0 (0.984)
WES 2B	1/4-7/8	M8-M20	50.0 (1.969)	30.0 (1.181)	31.0 (1.220)	30.0 (1.181)	31.0 (1.220)	35.0 (1.378)	34.0 (1.339)
WES 3B	13/16-1-3/8	M14-M33	72.0 (2.835)	48.0 (1.890)	48.0 (1.890)	44.0 (1.732)	41.0 (1.614)	55.5 (2.185)	45.0 (1.772)
WES 4B	1"-1-7/8	M22-M48	95.0 (3.740)	60.0 (2.362)	60.0 (2.362)	71.0 (2.795)	61.0 (2.402)	63.0 (2.480)	68.0 (2.677)

Size Metric	Shank Dia.	Square	DIN Spec	Catalog No.				
				WES 0	WES 1	WES 2	WES 3	WES 4
DIN-371								
M3	3.5 (0.138)	2.7 (0.106)	DIN 371	29201025	21200017			
M4	4.5 (0.177)	3.4 (0.134)	DIN 371	29201044	21200030			
M5	6.0 (0.236)	4.9 (0.193)	DIN 371	29201067	21201054			
M6	6.0 (0.236)	4.9 (0.193)	DIN 371	29202067	21202054	22201004		
M7	7.0 (0.276)	5.5 (0.217)	DIN 371	29201082	21201068	22201011		
M8	8.0 (0.315)	6.2 (0.244)	DIN 371	29201087	21201086	22201020		
M9	9.0 (0.354)	7.0 (0.276)	DIN 371		21201099	22201031		
M10	10.0 (0.394)	8.0 (0.315)	DIN 371		21201115	22201041		
DIN-376								
M8	6.0 (0.236)	4.9 (0.193)	DIN 376	29201067	21203054	22202004		
M10	7.0 (0.276)	5.5 (0.217)	DIN 376	29201082	21201068	22201011		
M12	9.0 (0.354)	7.0 (0.276)	DIN 376		21201099	22201031		
M14	11.0 (0.433)	9.0 (0.354)	DIN 376		21201123	22201046	23201004	
M16	12.0 (0.472)	9.0 (0.354)	DIN 376			22200056	23201006	
M18	14.0 (0.551)	11.0 (0.433)	DIN 376			22201069	23201011	
M20	16.0 (0.630)	12.0 (0.472)	DIN 376			22201084	23201016	
M22	18.0 (0.7087)	14.5 (0.5709)	DIN 376			22201097	23201024	24201002
M24	18.0 (0.7087)	14.5 (0.5709)	DIN 376			22202097	23202024	24202002
M27	20.0 (0.7874)	16.0 (0.6299)	DIN 376				23201030	24600004
M30	22.0 (0.8661)	18.0 (0.7087)	DIN 376				23201035	24600006
M33	25.0 (0.9843)	20.0 (0.7874)	DIN 376				23201044	24600009
M36	28.0 (1.102)	22.0 (0.866)	DIN 376					24600012
M39	32.0 (1.260)	24.0 (0.945)	DIN 376					24201017
M42	32.0 (1.260)	24.0 (0.945)	DIN 376					24202017
M45	36.0 (1.417)	29.0 (1.142)	DIN 376					24201020
M48	36.0 (1.417)	29.0 (1.142)	DIN 376					24202020

Also available in JIS and ISO

NOTE: WES style also suitable for taps with axial coolant hole.

WEN / WEN KP (Slotted) | ANSI Quick Change Adjustable Length Tap Adapters

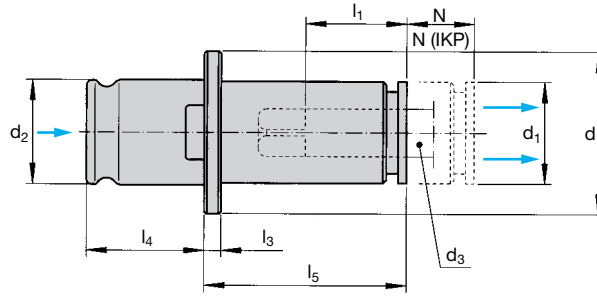

(KP coolant flow shown)

WEN / WEN KP – ANSI										
Designation	Tap Size	Dimensions (mm/inch)								
	Inch	d	d ₁	d ₂	l ₁	l ₃	l ₄	l ₅	N	N (KP)
WEN 0	#0-5/16	22.0 (0.787)	13.0 (.5118)	13.0 (.5118)	15.0 (0.591)	4.0 (.1575)	19.5 (.7677)	29.0 (1.142)	8.0 (.3150)	NA
WEN 1 / WEN 1 KP	#0-9/16	30.0 (1.181)	19.0 (0.748)	19.0 (0.748)	17.0 (0.669)	4.0 (.1575)	21.5 (.8465)	34.0 (1.339)	10.0 (.3937)	6.5 (0.256)
WEN 2 / WEN 2 KP	1/4-7/8	48.0 (1.890)	30.0 (1.181)	31.0 (1.220)	30.0 (1.181)	5.0 (.1969)	35.0 (1.378)	60.0 (2.362)	15.0 (.5906)	10.0 (0.551)
WEN 3 / WEN 3 KP	13/16-1-3/8	70.0 (2.756)	48.0 (1.890)	48.0 (1.890)	44.0 (1.732)	6.0 (.2362)	55.5 (2.185)	83.0 (3.267)	25.0 (.9843)	25.0 (.9843)
WENR2 / WENR KP	1/8-1/2 NPT	48.0 (1.890)	30.0 (1.181)	31.0 (1.220)	30.0 (0.827)	5.0 (.1969)	35.0 (1.378)	60.0 (2.362)	15.0 (.5906)	10.0 (0.551)
WENR3	3/8-1" NPT	70.0 (2.756)	48.0 (1.890)	48.0 (1.890)	44.0 (0.984)	6.0 (.2362)	55.5 (2.185)	83.0 (3.267)	25.0 (.9843)	25.0 (.9843)
Size		Shank Dia.	Square	Catalog No.						
Inch	Metric			WEN 0	WEN 1	WEN 1 KP	WEN 2	WEN 2 KP	WEN 3	
Hand Taps										
#0-6	M3	0.141	0.11	29300028	21300019	21369432				
#8, 5/32	M4	0.168	0.131	29300041	21300027	21369431				
#10, 3/16	M4.5, M5	0.194	0.152	29300052	21300038	21369429				
#12, 7/32		0.220	0.165	29300062	21300046	21369036				
1/4, #14	M6, M6.5	0.255	0.191	29300077	21300063	21369419	22300010			
5/16	M7, M8	0.318	0.238	29300101	21300089	21369420	22300022	22367430		
3/8	M10	0.381	0.286		21300112	21369421	22300040	22367424		
7/16		0.323	0.242		21300091	21369422	22300023	22367433		
1/2	M12, M12.5	0.367	0.275		21300105	21369423	22300033	22367418		
9/16	M14	0.429	0.322		21300119	21369424	22300043	22367428		
5/8	M16	0.480	0.36				22300058	22367419		
11/16	M18	0.542	0.406				22300067	22367438		
3/4		0.590	0.442				22300147	22367420		
13/16	M20	0.652	0.489				22300089	22367436	23300018	
39636	M22	0.697	0.523				22300093	22367434	23300021	
15/16	M24	0.760	0.57						23300028	
1"	M25	0.800	0.6						23300031	
1-1/8		0.896	0.672						23300038	
1-1/4	M30	1.021	0.766						23300045	
1-3/8	M33	1.108	0.831						23300053	
Size		Shank Dia.	Square	Catalog No.						
Inch	Metric			WEN 1	WEN 1 KP	WENR* 2	WENR 2 KP	WENR* 3		
Pipe Taps										
1/8 NPT	SMALL SHANK	0.3125	0.234	21300081	21369430					
1/8 NPT	LARGE SHANK	0.437	0.328	21300124	21369435	22302016				
1/4 NPT	1/4 NPT	0.562	0.421			22302002				
3/8 NPT	3/8 NPT	0.700	0.531			22302005			23302035	
1/2 NPT	1/2 NPT	0.688	0.515			22302004	22302804		23302036	
3/4 NPT	3/4 NPT	0.906	0.679						23302004	
1" NPT	1" NPT	1.125	0.843						23302007	

NOTE: WEN also suitable for taps with axial coolant hole
 WEN KP style delivers coolant around tap shank for non-coolant taps
 *WENR are non-coolant through

WEN / WEN KP (Slotted) | DIN/Metric Quick Change Adjustable Length Tap Adapters

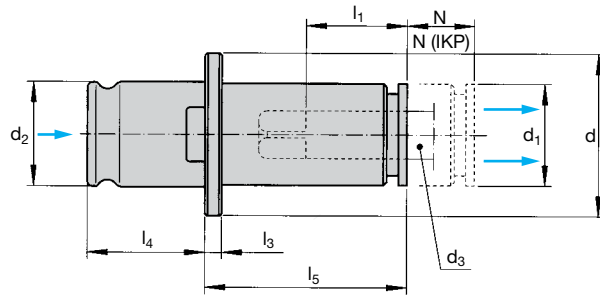

(KP coolant flow shown)

WEN / WEN KP – DIN 371/376										
Designation	Tap Size		Dimensions (mm/inch)							
	Metric	d	d ₁	d ₂	l ₁	l ₃	l ₄	l ₅	N	N (KP)
WEN 0	M1-M10	22.0 (0.787)	13.0 (.5118)	13.0 (.5118)	15.0 (0.591)	4.0 (.1575)	19.5 (.7677)	29 (1.142)	8.0 (.3150)	NA
WEN 1 / WEN 1 KP	M3-M12	30.0 (1.181)	19.0 (0.748)	19.0 (0.748)	17.0 (0.669)	4.0 (.1575)	21.5 (.8465)	34.0 (1.339)	10.0 (.3937)	6.5 (0.256)
WEN 2 / WEN 2 KP	M8-M20	48.0 (1.890)	30.0 (1.181)	31.0 (1.220)	30.0 (1.181)	5.0 (.1969)	35.0 (1.378)	60.0 (2.362)	15.0 (.5906)	10.0 (0.551)
WEN 3	M14-M33	70.0 (2.756)	48.0 (1.890)	48.0 (1.890)	44.0 (1.732)	6.0 (.2362)	55.5 (2.185)	83.0 (3.267)	25.0 (.9843)	25.0 (.9843)
Size Metric	Shank Dia.	Square	DIN Spec	Catalog No.						
				WEN 0	WEN 1	WEN 1 KP	WEN 2	WEN 2 KP	WEN 3	
Large Shank Taps										
M3	3.5 (0.138)	2.7 (0.106)	DIN 371	29300025	21300017					
M4	4.5 (0.177)	3.4 (0.134)	DIN 371	29300044	21300030					
M5	6.0 (0.236)	4.9 (0.193)	DIN 371	29300067	21300054	21369411	22300004			
M6	6.0 (0.236)	4.9 (0.193)	DIN 371	29300067	21300054	21369411	22300004	22367021		
M7	7.0 (0.276)	5.5 (0.217)	DIN 371	29300082	21300068	21369409	22300011	22367023		
M8	8.0 (0.315)	6.2 (0.244)	DIN 371	29300087	21300086	21369401	22300020	22367002		
M9	9.0 (0.354)	7.0 (0.276)	DIN 371		21300099	21369403	22300031	22367004		
M10	10.0 (0.394)	8.0 (0.315)	DIN 371		21300115	21369405	22300041	22367406		
Small Shank Taps										
M8	6.0 (0.236)	4.9 (0.193)	DIN 376	29300067	21300054	21369411	22300004	22367021		
M10	7.0 (0.276)	5.5 (0.217)	DIN 376	29300082	21300068	21369409	22300011	22367023		
M12	9.0 (0.354)	7.0 (0.276)	DIN 376		21300099	21369403	22300031	22367004		
M14	11.0 (0.433)	9.0 (0.354)	DIN 376		21300123	21369406	22300046	22367407	23300004	
M16	12.0 (0.472)	9.0 (0.354)	DIN 376				22300056	22367009	23300006	
M18	14.0 (0.551)	11.0 (0.433)	DIN 376				22300069	22367411	23300011	
M20	16.0 (0.630)	12.0 (0.472)	DIN 376				22300084	22367013	23300016	
M22	18.0 (0.709)	14.5 (0.571)	DIN 376				22300097	22367016	23300024	
M24	18.0 (0.709)	14.5 (0.571)	DIN 376				22300097	22367016	23300024	
M27	20.0 (0.787)	16.0 (0.630)	DIN 376						23300030	
M30	22.0 (0.866)	18.0 (0.709)	DIN 376						23300035	
M33	25.0 (0.984)	20.0 (0.787)	DIN 376						23300044	

NOTE: WEN also suitable for taps with axial coolant hole
 WEN KP style delivers coolant around tap shank for non-coolant taps

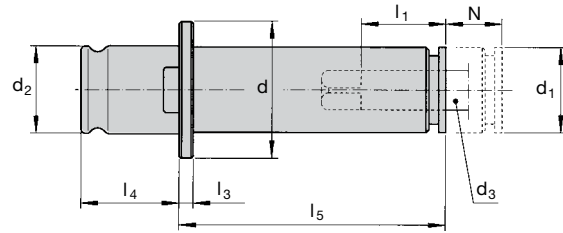

WEN-V – Extended Length Adjustable Adapters

Designation			d_3		d	d_1	d_2	l_1	l_3	l_4	l_5												
WEN0-...	M 1 – M 10	2.5-7.2	0	8	22	13	13	15	4	19.5	40	50	60	70	80	90	100	110	120				
WEN1-...	M 3 – M 12	3.5-11.3	1	10	30	19	19	17	4	21.5	40	50	60	70	80	90	100	110	120	130	140		
WEN2-...	M 8 – M 20	7.0-18	2	15	48	31	31	30	5	35	70	80	90	100	110	120	130	140	150	160			
WEN3-...	M14 – M 33	11-28	3	25	70	48	48	44	6	55.5	100	120	140	160	180								
WEN40-...	M 6 – M 18	6.0-14	40	15	40	25	26	30	5	32	60	70	80	90	100	110	120	130	140	150			

Example for ordering WEN1-80 then tap size

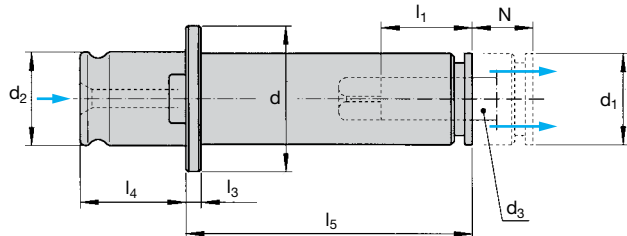

WEN-V-KP – Extended Length Adjustable Adapters

Designation			d_3		d	d_1	d_2	l_1	l_3	l_4	l_5												
WEN1-KP...	M 3 – M 12	3.5-11.3	1	6.5	30	19	19	17	4	21.5	40	50	60	70	80	90	100	110	120	130	140		
WEN2-KP...	M 8 – M 20	7.0-18	2	14	48	30	31	30	5	35	70	80	90	100	110	120	130	140	150	160			
WEN3-KP...	M14 – M 33	11-28	3	25	70	48	48	44	6	55.5	100	120	140	160	180								

Example for ordering WEN2-KP-120 then tap size

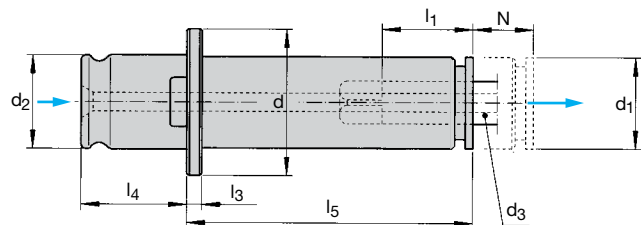

WEN-V-IKP – Extended Length Adjustable Adapters – Coolant Through

Designation			d_3		d	d_1	d_2	l_1	l_3	l_4	l_5												
WEN1-IKP...	M 3-M 12	3.5-11.3	1	6.5	30	19	19	17	4	21.5	40	50	60	70	80	90	100	110	120	130	140		
WEN2-IKP...	M 8-M 20	7.0-18	2	14	48	30	31	30	5	35	70	80	90	100	110	120	130	140	150	160			
WEN3-IKP...	M14-M 33	11-28	3	25	70	48	48	44	6	55.5	100	120	140	160	180								

Example for ordering WEN1-IKP-60 then tap size



ER Collet – Quick Change Adapters									
	Catalog No.	Designation	Series	Range		Seal Disc	Dimensions (mm)		Collet Nut
				Inch	Metric		d ₂	l	
	21116000	WE1-IKP/ESX16GB	ER16	#8-5/16	M4-M10	DS/ER16	28	28	ER16*
	21120000	WE1-IKP/ESX20GB	ER20	#8-1/2	M4-M12	DS/ER20	34	38	ER20*
	22125000	WE2-IKP/ESX25GB	ER25	#8-3/4	M4-M16	DS/ER25	42	37	ER25*
	22132000	WE2-IKP/ESX32GB	ER32	#8-13/16	M4-M20	DS/ER32	50	40	ER32*

Can be used with square drive tap collets or cylindrical collets

NOTE: All are designed for through coolant

*See page 18



WEK – Extended Range Adapters										
	Catalog No.	Designation	Size	Dimensions (inch)		Dimensions (mm)				
				Tap Shank	Square	d	d ₁	l ₁	l ₃	l ₄
	21101004	WEK1 5/8	1	0.480	0.360	30	19	13	4	21.5
	22101007	WEK2 15/16	2	0.760	0.570	48	31	20	5	35
	22101003	WEK2 1"	2	0.800	0.600	48	31	20	5	35
	23101005	WEK3 1-1/2"	3	1.233	0.925	70	48	36	6	55.5
	24158001	WEKR4 2"	4	1.644	1.233	92	60	50	21	63

NOTE: For light machining only



WESK – Extended Range Shank with Torque Clutch										
	Catalog No.	Designation	Size	Dimensions (inch)		Dimensions (mm)				
				Tap Shank	Square	d	d ₁	l ₁	l ₃	l ₄
	21601004	WESK1 B 5/8	1	0.480	0.360	32	19	27.5	25	21.5
	22601007	WESK2 B 15/16	2	0.760	0.570	50	31	32.5	31	35
	22601003	WESK2 B 1"	2	0.800	0.600	50	31	32.5	31	35
	23601005	WESK3 B 1-1/2"	3	1.233	0.925	72	48	40	41	55.5
	24601011	WESK4 B 2"	4	1.644	1.233	95	60	54	61	63

NOTE: For light machining only



WRE – Reducing Adapters									
	Catalog No.	Designation	Size		Dimensions (mm)				
			OD	ID	d	d ₁	l ₁	l ₃	l ₄
	22132911	WRE 2/1	2	1	48	19	31	5	35
	23132911	WRE 3/1	3	1	70	19	48	6	55.5
	23132912	WRE 3/2	3	2	70	31	48	6	55.5
	24132912	WRE 4/2	4	2	92	31	60	13	63
	24132913	WRE 4/3	4	3	92	48	60	13	63

DIN
6327

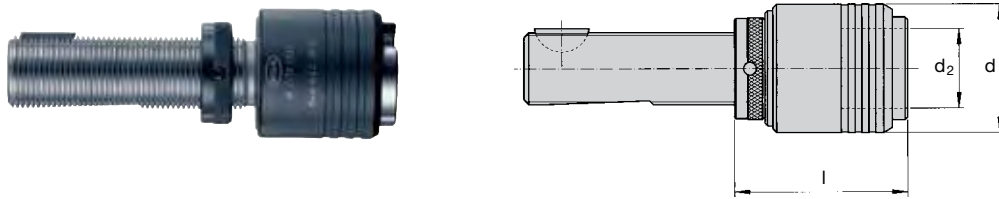

WF – ACME

SAP No.	Catalog No.	Designation	Adapter Size	Tap Range			Dimensions (inch)		
				Metric	Inch	Pipe	l	d	d ₂
6708480	11310016	WF1 / 5/8	1	M3-M12	#0-9/16	1/8	1.890	1.260	0.748
6708482	11310018	WF1 / 3/4	1	M3-M12	#0-9/16	1/8	1.890	1.260	0.748
6708481	11310017	WF1 / 7/8	1	M3-M12	#0-9/16	1/8	1.890	1.260	0.748
6708483	11310020	WF1 / 1-1/16	1	M3-M12	#0-9/16	1/8	1.890	1.260	0.748
6708523	11320020	WF2 / 1-1/16	2	M8-M20	5/16-7/8	1/4-1/2	2.559	1.969	1.220
6708524	11320021	WF2 / 1-3/8	2	M8-M20	5/16-7/8	1/4-1/2	2.559	1.969	1.220
6708556	11330021	WF3 / 1-3/8	3	M14-M33	13/16-1-3/8	3/8-1"	3.700	2.835	1.890

WF – TR

SAP No.	Catalog No.	Designation	Adapter Size	Tap Range			Dimensions (mm)		
				Metric	Inch	Pipe	l	d	d ₂
6708463	11300001	WF0/TR16	0	M1-M10	#0-1/4	–	45	23	13
6708464	11300003	WF0/TR20	0	M1-M10	#0-1/4	–	45	23	13
6708477	11310001	WF1/TR16	1	M3-M12	#0-9/16	1/8	49	32	19
6708478	11310003	WF1/TR20	1	M3-M12	#0-9/16	1/8	49	32	19
6708479	11310006	WF1/TR28	1	M3-M12	#0-9/16	1/8	49	32	19
6708519	11320003	WF2/TR20	2	M8-M20	5/16-7/8	1/4-1/2	66	50	31
6708520	11320006	WF2/TR28	2	M8-M20	5/16-7/8	1/4-1/2	66	50	31
6708521	11320009	WF2/TR36	2	M8-M20	5/16-7/8	1/4-1/2	68	50	31
6708550	11330006	WF3/TR28	3	M14-M33	13/16-1-3/8	3/8-1"	95	72	48
6708553	11330009	WF3/TR36	3	M14-M33	13/16-1-3/8	3/8-1"	97	72	48

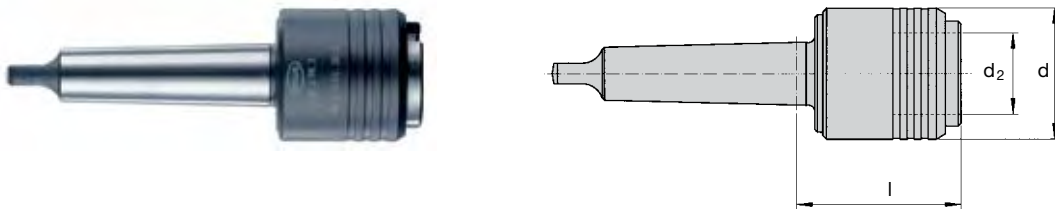

DIN
228B

WF – Morse Taper

SAP No.	Catalog No.	Designation	Adapter Size	Tap Range			Dimensions (mm)		
				Metric	Inch	Pipe	l	d	d ₂
11300024	11300024	WF0/MT1	0	M1-M10	#0-1/4	–	39	23	13
6708486	11310025	WF1/MT2	1	M3-M12	#0-9/16	1/8	44	32	19
6708526	11320028	WF2/MT3	2	M8-M20	5/16-7/8	1/4-1/2	61	50	31
6708558	11330028	WF3/MT3	3	M14-M33	13/16-1-3/8	3/8-1"	90	72	48
6708559	11330031	WF3/MT4	3	M14-M33	13/16-1-3/8	3/8-1"	91	72	48

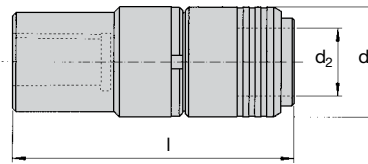

WF – B Taper									
SAP No.	Catalog No.	Designation	Adapter Size	Tap Range			Dimensions (mm)		
				Metric	Inch	Pipe	l	d	d ₂
6708470	11300041	WF0/B12	0	M1-M10	#0-1/4	–	55	23	13
6708491	11310041	WF1/B12	1	M3-M12	#0-9/16	1/8	59	32	19
6708492	11310042	WF1/B16	1	M3-M12	#0-9/16	1/8	65	32	19
6708528	11320042	WF2/B16	2	M8-M20	5/16-7/8	1/4-1/2	84	50	31
6708529	11320043	WF2/B18	2	M8-M20	5/16-7/8	1/4-1/2	92	50	31

WFLK B | Quick Change Tension & Compression Chucks

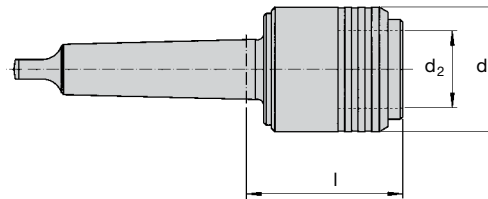

WFLK B – Morse Taper											
SAP No.	Catalog No.	Designation	Adapter Size	Tap Range			Length Compensation		Dimensions (mm)		
				Metric	Inch	Pipe	Comp.	Tens.	l	d	d ₂
6710070	12400125	WFLK 013 B/ MT 2	0	M1-M10	#0-1/4	-	6.5mm	6.5mm	45.0	26.0	13.0
6710082	12410125	WFLK 115 B/ MT 2	1	M3-M12	#0-9/16	1/8	7.5mm	7.5mm	47.0	36.0	19.0
6710084	12410128	WFLK 115 B/ MT 3	1	M3-M12	#0-9/16	1/8	7.5mm	7.5mm	47.0	36.0	19.0
6710097	12420128	WFLK 225 B/ MT 3	2	M8-M20	5/16-7/8	1/4-1/2	12.5mm	12.5mm	71.0	53.0	31.0
6710099	12420131	WFLK 225 B/ MT 4	2	M8-M20	5/16-7/8	1/4-1/2	12.5mm	12.5mm	72.0	53.0	31.0
6710111	12430131	WFLK 340 B/ MT 4	3	M14-M33	13/16-1-3/8	3/8-1"	20.0mm	20.0mm	114.0	75.0	48.0
6710123	12440134	WFLK 445 B/ MT 5	4	M22-M48	1-3/8-1-3/4	3/4-1-1/2	22.5mm	22.5mm	116.5	93.0	60.0

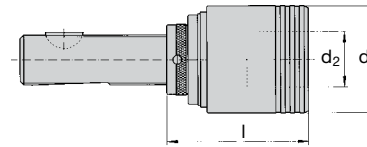

WFLK B – ACME

SAP No.	Catalog No.	Designation	Adapter Size	Dimensions (inch)							
				Tap Range			Length Compensation		d	d ₂	l
				Metric	Inch	Pipe	Comp.	Tens.			
Tension & Compression											
6710065	12400016	WFLK 013 B/5/8	0	M1-M10	#0-1/4	–	0.260	0.260	1.024	0.512	1.870
6710066	12400018	WFLK 013 B/3/4	0	M1-M10	#0-1/4	–	0.260	0.260	1.024	0.512	1.870
6710073	12410018	WFLK 115 B/3/4	1	M3-M12	#0-9/16	1/8	0.300	0.300	1.417	0.748	1.969
6710072	12410017	WFLK 115 B/7/8	1	M3-M12	#0-9/16	1/8	0.300	0.300	1.417	0.748	1.969
6710075	12410020	WFLK 115 B/1-1/16	1	M3-M12	#0-9/16	1/8	0.300	0.300	1.417	0.748	1.969
6710090	12420020	WFLK 225 B/1-1/16	2	M8-M20	5/16-7/8	1/4-1/2	0.490	0.490	2.087	1.220	2.913
6710091	12420021	WFLK 225 B/1-3/8	2	M8-M20	5/16-7/8	1/4-1/2	0.490	0.490	2.087	1.220	2.913
6710106	12430021	WFLK 340 B/1-3/8	3	M14-M33	13/16-1-3/8	3/8-1"	0.790	0.790	3.071	1.890	4.213
Tension Only											
6709066	12008119	WFLK 013-0 B/5/8	0	M1-M10	#0-1/4	–	0.000	0.520	1.024	0.512	1.870
6709065	12008118	WFLK 013-0 B/3/4	0	M1-M10	#0-1/4	–	0.000	0.520	1.024	0.512	1.870
6709340	12018485	WFLK 115-0 B/3/4	1	M3-M12	#0-9/16	1/8	0.000	0.600	1.417	0.748	1.969
6709346	12018491	WFLK 115-0 B/7/8	1	M3-M12	#0-9/16	1/8	0.000	0.600	1.417	0.748	1.969
6709339	12018484	WFLK 115-0 B/1-1/16	1	M3-M12	#0-9/16	1/8	0.000	0.600	1.417	0.748	1.969
6709644	12028558	WFLK 225-0 B/1-1/16	2	M8-M20	5/16-7/8	1/4-1/2	0.000	0.980	2.087	1.220	2.913
6709645	12028559	WFLK 225 B-0/1-3/8	2	M8-M20	5/16-7/8	1/4-1/2	0.000	0.980	2.087	1.220	2.913
6709809	12038359	WFLK 340 B-0/1-3/8	3	M14-M33	13/16-1-3/8	3/8-1"	0.000	1.580	3.071	1.890	4.213

WFLK B – TR

SAP No.	Catalog No.	Designation	Adapter Size	Dimensions (mm)							
				Tap Range			Length Compensation		d	d ₂	l
				Metric	Inch	Pipe	Comp.	Tens.			
6710068	12400101	WFLK 013B/TR16	0	M1-M10	#0-1/4	–	6.5	6.5	26.0	13.0	50.0
6710069	12400103	WFLK 013B/TR20	0	M1-M10	#0-1/4	–	6.5	6.5	26.0	13.0	50.0
6710078	12410101	WFLK 115B/TR16	1	M3-M12	#0-9/16	1/8	7.5	7.5	36.0	19.0	52.0
6710079	12410103	WFLK 115B/TR20	1	M3-M12	#0-9/16	1/8	7.5	7.5	36.0	19.0	52.0
6710080	12410106	WFLK 115B/TR28	1	M3-M12	#0-9/16	1/8	7.5	7.5	36.0	19.0	52.0
6710095	12420106	WFLK 225B/TR28	2	M8-M20	5/16-7/8	1/4-1/2	12.5	12.5	53.0	31.0	76.0
6710096	12420109	WFLK 225B/TR36	2	M8-M20	5/16-7/8	1/4-1/2	12.5	12.5	53.0	31.0	78.0
6710108	12430106	WFLK 340B/TR28	3	M14-M33	13/16-1-3/8	3/8-1"	20.0	20.0	75.0	48.0	109.0
6710109	12430109	WFLK 340B/TR36	3	M14-M33	13/16-1-3/8	3/8-1"	20.0	20.0	75.0	48.0	111.0

Tension Only Available

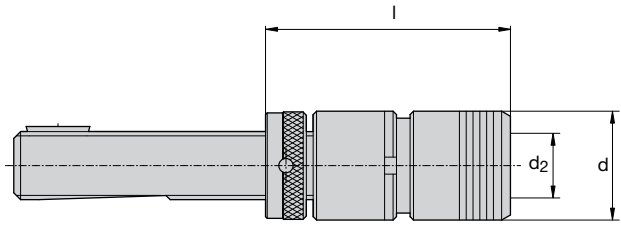
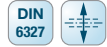

WFP – ACME										
SAP No.	Catalog No.	Designation	Adapter Size	Tap Range			Dimensions (inch)			
				Metric	Inch	Pipe	Float	l	d	d ₂
6708333	11200016	WFP0 / 5/8	0	M1-M10	#0-1/4	–	0.01	0.906	0.512	2.52
6708334	11200018	WFP0 / 3/4	0	M1-M10	#0-1/4	–	0.01	0.906	0.512	2.52
6708350	11210016	WFP1 / 5/8	1	M3-M12	#0-9/16	1/8	0.02	1.26	0.748	2.717
6708352	11210018	WFP1 / 3/4	1	M3-M12	#0-9/16	1/8	0.02	1.26	0.748	2.717
6708351	11210017	WFP1 / 7/8	1	M3-M12	#0-9/16	1/8	0.02	1.26	0.748	2.717
6708354	11210020	WFP1 / 1-1/16	1	M3-M12	#0-9/16	1/8	0.02	1.26	0.748	2.717
6708355	11210021	WFP1 / 1-3/8	1	M3-M12	#0-9/16	1/8	0.02	1.26	0.748	2.717
6708409	11220020	WFP2 / 1-1/16	2	M8-M20	5/16-7/8	1/4-1/2	0.039	0.039	1.220	3.74
6708410	11220021	WFP2 / 1-3/8	2	M8-M20	5/16-7/8	1/4-1/2	0.039	0.039	1.220	3.74
6708440	11230021	WFP3 / 1-3/8	3	M14-M33	13/16-1-3/8	1/2-1"	0.059	0.059	1.890	5.315

WFP – TR										
SAP No.	Catalog No.	Designation	Adapter Size	Tap Range			Dimensions (mm)			
				Metric	Inch	Pipe	Float	l	d	d ₂
6708330	11200001	WFP0/TR16	0	M1-M10	#0-1/4	–	0.25	23	13	65
6708332	11200003	WFP0/TR20	0	M1-M10	#0-1/4	–	0.25	23	13	65
6708345	11210001	WFP1/TR16	1	M3-M12	#0-9/16	1/8	0.50	32	19	70
6708346	11210003	WFP1/TR20	1	M3-M12	#0-9/16	1/8	0.50	32	19	70
6708349	11210006	WFP1/TR28	1	M3-M12	#0-9/16	1/8	0.50	32	19	70
6708400	11220003	WFP2/TR20	2	M8-M20	5/16-7/8	1/4-1/2	1.00	50	31	96
6708402	11220006	WFP2/TR28	2	M8-M20	5/16-7/8	1/4-1/2	1.00	50	31	96
6708403	11220009	WFP2/TR36	2	M8-M20	5/16-7/8	1/4-1/2	1.00	50	31	96
6708436	11230006	WFP3/TR28	3	M14-M33	13/16-1-3/8	1/2-1"	1.50	72	48	136
6708438	11230009	WFP3/TR36	3	M14-M33	13/16-1-3/8	1/2-1"	1.50	72	48	138

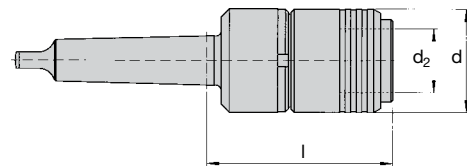

WFP – Morse Taper										
SAP No.	Catalog No.	Designation	Adapter Size	Tap Range			Dimensions (mm)			
				Metric	Inch	Pipe	Float	l	d	d ₂
6708335	11200024	WFP0/MT1	0	M1-M10	#0-1/4	–	0.25	59	23	13
6708336	11200025	WFP0/MT2	0	M1-M10	#0-1/4	–	0.25	60	23	13
6708356	11210024	WFP1/MT1	1	M3-M12	#0-9/16	1/8	0.50	64	32	19
6708357	11210025	WFP1/MT2	1	M3-M12	#0-9/16	1/8	0.50	65	32	19
6708412	11220028	WFP2/MT3	2	M8-M20	5/16-7/8	1/4-1/2	1.00	91	50	31
6708413	11220031	WFP2/MT4	2	M8-M20	5/16-7/8	1/4-1/2	1.00	92	50	31
6708443	11230031	WFP3/MT4	3	M14-M33	13/16-1-3/8	1/2-1"	1.50	132	72	48

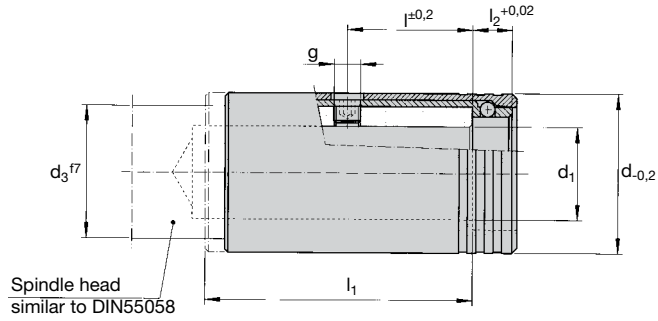

ASBA – Inch				Dimensions (inch)							
SAP No.	Catalog No.	Designation	Nut Size	d ₁	adj. adaptors	d	d ₃	g (UNF)	l	l ₁	l ₂
6724485	33001010	ASBA .500"	SSM .500"	0.500	1/2"-16	0.945	0.735	1/4-28	1.25	2.46	0.354
6724501	33003002	ASBA .625"	SSM .625"	0.625	5/8"-16	1.181	0.985	5/16-24	1.25	2.58	0.374
6724502	33003003	ASBA .750"	SSM .750"	0.750	3/4"-12	1.496	1.235	5/16-24	1.25	2.72	0.433
6724503	33003004	ASBA .875"	SSM .875"	0.875	7/8"-12	1.654	1.360	5/16-24	1.56	3.19	0.472
6724514	33005010	ASBA 1.000"	SSM 1.000"	1.000	1"-12	1.811	1.484	5/16-24	1.56	3.23	0.472
6724504	33003006	ASBA 1.063"	SSM 1.063"	1.063	1-1/16"-12	1.929	1.510	5/16-24	1.56	3.27	0.472
6724505	33003007	ASBA 1.375"	SSM 1.375"	1.375	1-3/8"-12	2.362	1.985	5/16-24	1.81	3.94	0.630

ASBA – Metric				Dimensions (mm)							
SAP No.	Catalog No.	Designation	Nut Size	d ₁	Screw No.	d	d ₃	g	l	l ₁	l ₂
6724515	33012010	ASBA 12	SSM 12	12	BN 138-62	24	20	M5	22	52	9
6724523	33016010	ASBA 16	SSM 16	16	BN 138-25	30	25	M6	34	67	9.5
6724540	33020010	ASBA 20	SSM 20	20	BN 138-25	38	32	M6	34	72	11
6724561	33025010	ASBA 25	SSM 25	25	BN 138-4	45	37	M8	38	79	12
6724573	33028010	ASBA 28	SSM 28	28	BN 138-4	48	40	M8	38	81	12
6724605	33036010	ASBA 36	SSM 36	36	BN 138-5	60	50	M8	45	100	16

SSM | Quick Change Adjusting Nut

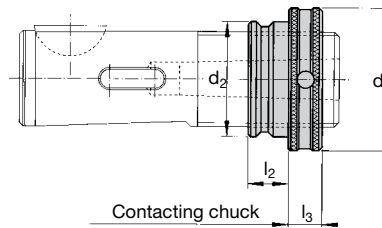

SSM – Inch			Dimensions (inch)				
SAP No.	Catalog No.	Designation	ACME	d	d ₂	l ₂	l ₃
6724493	33002001	SSM .500"	1/2"-16	0.846	0.645	0.354	0.354
6724494	33002002	SSM .625"	5/8"-16	1.023	0.783	0.374	0.354
6724495	33002003	SSM .750"	3/4"-12	1.299	1.000	0.433	0.354
6724496	33002004	SSM .875"	7/8"-12	1.456	1.137	0.472	0.393
6724497	33002005	SSM 1.000"	1"-12	1.574	1.256	0.472	0.393
6724498	33002006	SSM 1.063"	1-1/16"-12	1.653	1.334	0.473	0.393
6724499	33002007	SSM 1.375"	1-3/8"-12	2.126	1.708	0.629	0.393
6724500	33002008	SSM 1.875"	1-7/8"-12	2.824	2.279	0.787	0.551

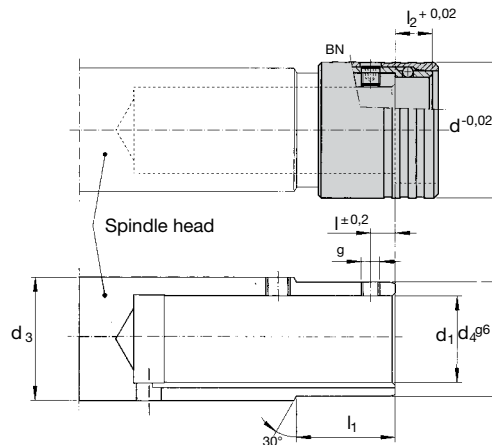

ASBVA – Inch												
SAP No.	Catalog No.	Designation	Nut Size	Dimensions (inch)								
				d ₁	Screw No.	d	d ₃	g (UNF)	l	l ₁	l ₂	d ₄
6724506	33004002	ASBVA 5/8"	SSM 5/8"	0.625	BN 138-65	1.102	0.985	Nr 10-32	0.315	1.181	0.394	0.905
6724507	33004003	ASBVA 3/4"	SSM 3/4"	0.750	BN 138-65	1.338	1.235	Nr 10-32	0.315	1.181	0.433	1.102
6724508	33004004	ASBVA 7/8"	SSM 7/8"	0.875	BN 138-65	1.535	1.360	Nr 10-32	0.315	1.260	0.472	1.259
6724510	33004006	ASBVA 1-1/16"	SSM 1-1/16"	1.062	BN 138-30	1.732	1.610	1/4-28	0.315	1.260	0.472	1.456
6724511	33004007	ASBVA 1-3/8"	SSM 1-3/8"	1.375	BN 138-31	2.244	1.985	1/4-28	0.354	1.535	0.630	1.870

ASBVA – Metric												
SAP No.	Catalog No.	Designation	Nut Size	Dimensions (mm)								
				d ₁	Screw No.	d	d ₃	g (UNF)	l	l ₁	l ₂	
6724533	33016051	ASBVA 16	SSM 16	16	BN 138-11	27	25	M5	8	30	9.5	
6724553	33020051	ASBVA 20	SSM 20	20	BN 138-11	34	32	M5	8	30	11	
6724568	33025051	ASBVA 25	SSM 25	25	BN 138-2	41	37	M6	8	32	12	
6724587	33028051	ASBVA 28	SSM 28	28	BN 138-25	44	40	M6	8	32	12	
6724602	33032051	ASBVA 32	SSM 32	32	BN 138-2	49	45	M6	9	39	13.5	
6724618	33036051	ASBVA 36	SSM 36	36	BN 138-2	55	50	M6	9	39	16	
6724632	33048051	ASBVA 48	SSM 48	48	BN 138-5	73	67	M8	11	51	20	

SSM | Quick Change Adjusting Nut

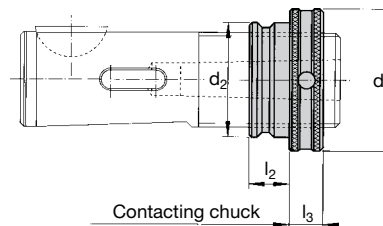

SSM – Metric									
SAP No.	Catalog No.	Designation	Dimensions (mm)						
			TR	d	d ₂	l ₂	l ₃		
6724517	33012020	SSM 12	12	22	16.4	9.0	9		
6724527	33016020	SSM 16	16	26	19.9	9.5	9		
6724544	33020020	SSM 20	20	33	25.4	11.0	9		
6724563	33025020	SSM 25	25	40	31.9	12.0	10		
6724577	33028020	SSM 28	28	42	33.9	12.0	10		
6724595	33032020	SSM 32	32	47	37.9	13.5	10		
6724608	33036020	SSM 36	36	54	43.4	16.0	10		
6724627	33048020	SSM 48	48	72	57.9	20.0	14		

APPLICATION: For drilling, counterboring, chamfering, reaming and tapping operations on drilling radial drilling machines and NC machines.

FEATURES: Quick change system with automatic locking of the adaptor in the chuck. Tool changes can be made with rotating spindle. Minimum movement when changing tools. High concentricity of the adaptor in the chuck is achieved by the axially and radially free-of-play location of the adaptor taper. Can be applied vertically and horizontally. For right and left hand rotation.

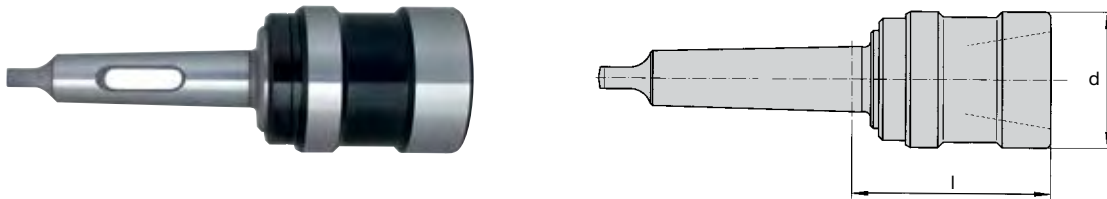

SBK – Morse Taper Shank					
SAP No.	Catalog No.	Designation	Dimensions (inch)		
			Size	d	l ₂
6723619	30120002	SBK2/MT2	2	1.968	2.952
6723620	30120003	SBK2/MT3	2	1.968	2.952
6723648	30130003	SBK3/MT3	3	2.362	3.464
6723649	30130004	SBK3/MT4	3	2.362	3.503
6723668	30140004	SBK4/MT4	4	2.834	4.015
6723669	30140005	SBK4/MT5	4	2.834	4.015

SELK | Quick Change Adaptor

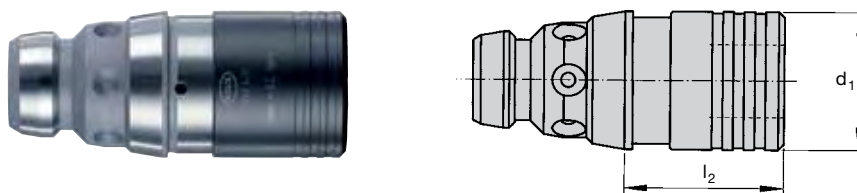

SELK – Tap Chuck									
SAP No.	Catalog No.	Designation	Dimensions (inch)						
			Adap. Size	Tap Range	Chuck Size	Tension	Compression	d	l ₂
6723643	30125001	SELK 2/1	1	#0-9/16"	2	0.295	0.295	1.417	1.653
6723644	30125002	SELK 2/2	2	5/16"-7/8"	2	0.492	0.492	2.086	2.834
6723662	30135002	SELK 3/2	2	5/16"-7/8"	3	0.492	0.492	2.086	2.598
6723663	30135003	SELK 3/3	3	13/16"-1-3/8"	3	0.787	0.787	3.070	4.960
6723693	30145003	SELK 4/3	3	13/16"-1-3/8"	3	0.787	0.787	3.070	4.763
6723694	30145004	SELK 4/4	4	1"-1-7/8"	4	0.885	0.885	3.779	5.314

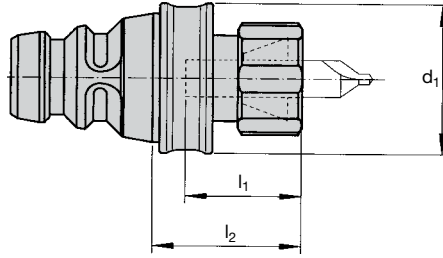

SEK – ER								
SAP No.	Catalog No.	Designation	Dimensions (mm)					
			ER Size	ER Range	l ₂ (min/max)	d	d ₂	l
6723783	30190204	SEK2/ESX16	ER 16	1mm-10mm	21/43	32	42	40
6723640	30121053	SEK2/ESX20	ER 20	1mm-13mm	22/47	34	42	46
6723744	30190140	SEK3/ESX25	ER 25	2mm-16mm	24/51	42	50	52
6723790	30190215	SEK3/ESX32	ER 32	3mm-20mm	29/56	50	50	53
6723780	30190196	SEK3/ESX40	ER 40	4mm-26mm	35/62	63	60	73
6723686	30141053	SEK4/ESX40	ER 40	4mm-26mm	35/62	63	60	70

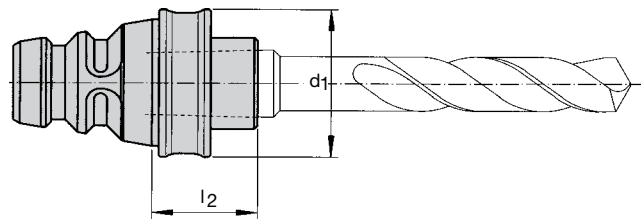

SEK – Morse Tap Adapter					
SAP No.	Catalog No.	Designation	Dimensions (inch)		
			Size	d ₁	l ₂
6723630	30121001	SEK2/MT1	2	1.653	0.708
6723631	30121002	SEK2/MT2	2	1.653	1.200
6723653	30131001	SEK3/MT1	3	1.968	0.807
6723654	30131002	SEK3/MT2	3	1.968	0.807
6723655	30131003	SEK3/MT3	3	1.968	1.515
6723675	30141002	SEK4/MT2	4	2.362	1.318
6723676	30141003	SEK4/MT3	4	2.362	1.318
6723677	30141004	SEK4/MT4	4	2.362	2.834

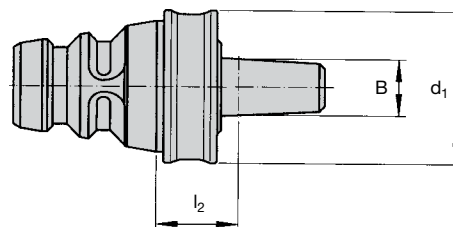

SEK – B				
SAP No.	Catalog No.	Designation	Dimensions (inch)	
			Size	d ₁
6723632	30121012	SEK2/B12	2	1.653
6723633	30121015	SEK2/B16	2	1.653
6723657	30131016	SEK3/B16	3	1.968
6723680	30141016	SEK4/B16	4	2.362

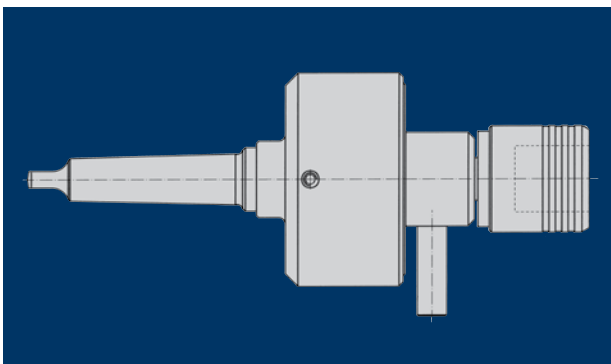

This self reversing tapping attachment is designed for use on drilling machines which have only manual feed facilities and which do not have a reversible spindle.

The tool design is simple, effective, and is virtually maintenance free. The unit is fitted into the machine spindle by virtue of its morse taper shank, with the stop arm located against the column of the drilling machine to ensure effective and positive action. The design of the units is such that it can be used for either right or left handed tapping operations.

The unit automatically changes direction when the manual feed is reversed.

The unit accepts both Bilz WE and WES tap adaptors.

The use of WES tap adaptors prevents tap breakage in bottoming hole tapping applications.

Application:

The tapping attachment is designed for use on vertical drilling machines.

Operation:

Before operation, the stop arm should be located in the tapped hole on the main body of the tapping attachment and screwed into position. The other end of the stop arm should then be in contact with either the main pillar of the drilling machine or an appropriate stop device mounted on the machine, the purpose of this is to prevent the tapping attachment from rotating. On the way out use approximately double feed rate.

Maintenance:

The tapping attachment is maintenance free.

Safety Precautions:

The stop arm must not be held in the hand and a safe distance between the operator and the machine should be greater than the length of the stop arm.

- Max. RPM for TA 12 is 1200 per minute
- Max. RPM for TA 20 is 500 per minute
- The tapping range for TA 12 is M 3-M 12
- The tapping range for TA 20 is M 8-M 20.
- Quick change adaptors with safety clutch must be used when tapping blind holes.

Risk of injury to the operator if the above precautions are not followed!

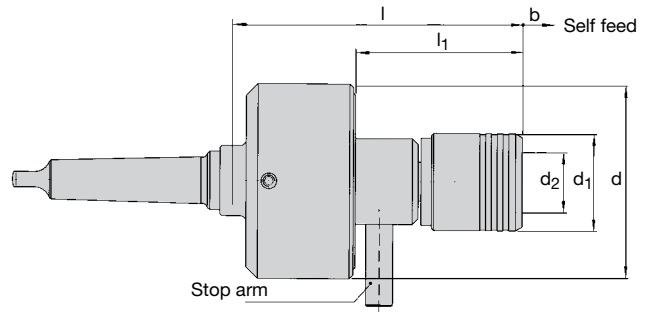

TA / MK-WF – Inch													
SAP No.	Designation			Max RPM	Dimensions (inch/mm)								
					b	l	l ₁	d	d ₁	d ₂			i
6802342	TA12 7/8-20-WF1	1	#4-1/2" M3-M12	1200	.236 6 mm	4.724 120 mm	2.362 60 mm	3.150 80 mm	1.260 32 mm	.748 19 mm	0	12.5	1.73
6802343	TA20 7/8-20-WF2	2	5/16-3/4" M8-M20	500	.315 8 mm	5.905 150 mm	3.386 86 mm	3.937 100 mm	1.969 50 mm	1.220 31 mm	0	16.5	1.88

i = gear ratio for return cycle

Shanks	
	SAP No.
	Designation
	6944728
	6944729
	6944730
	02003200
	02003300
	02003400
	02003500
	02005500
	02006100
	02012000
02012100	

DSPL | Tapping Chuck

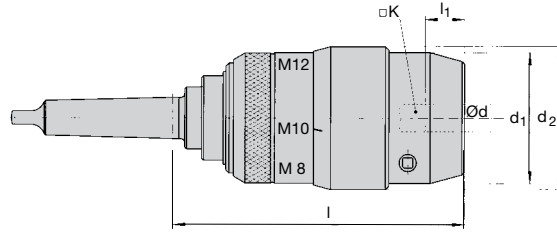

DSPL-MT – Inch												
SAP No.	Designation	Dimensions (inch)										Keys
		l	l ₁	Metric	Taps	Pipe	Float	Length Comp.		d	d ₁	
								Comp.	Tens.			
10121202	DSPL 12/MT 2	5.314	0.708-0x.787	M3-M12	#6-1/2	1/8	0.039	0.393	0.787	2.283	2.086	DSPLK 12
10121203	DSPL 12/MT 3											
10600057	DSPL 12/SS 3/4											
10600043	DSPL 12/SS 1	5.125										
10201203	DSPL 20/MT 3	6.692	0.905-1.102	M8-M20	1/8-3/4	1/8-1/4	0.058	0.393	0.787	3.267	2.992	DSPLK 20
10201204	DSPL 20/MT 4	6.732										
10600070	DSPL 20/SS 1	6.417										
10600024	DSPL 20/SS 1-1/4											
10301204	DSPL 30/MT 4	9.133	0.984-1.338	M14-M30	5/8-1-1/8	1/4-1/2	0.078	0.393	1.181	4.173	4.173	DSPLK 30
10301205	DSPL 30/MT 5											
10600025	DSPL 30/SS 1-1/4	8.740										
10421205	DSPL 42/MT 5	10.590	1.614-1.889	M18-M42	3/4-1-5/8	1/2-1"	0.078	0.393	1.181	4.921	4.724	DSPLK 40
10421006	DSPL 42/MT 6	10.668										
10600026	DSPL 42/SS 1-1/2	10.245										



High Performance Tapping Attachments with Integrated Reversing Gear

BILZ tapping attachments are of modular design and can therefore meet the specific requirements of individual machines. They can be used on machining centres with automatic tool changers and on special purpose machines.

Because of the integrated maintenance free reversing gear, changes in direction of the machine spindle are unnecessary.



The length compensation on extension, with a ball release system which operates when in reverse, guarantees thread depths of 60.15 mm up to a speed of 4000 rpm. The GNCK tapping unit with coolant feed, can facilitate pressures up to a maximum of 50 bar.

Precision collets ensure that the tap is securely clamped, and additional square drivers can be utilised where high torque is being generated, for example, when thread forming.

The torque support locks the unit relative to the spindle, thus making automatic tool changing possible. When tool changing takes place, the locking mechanism releases the torque support and allows the tool changing operation to be effected.

Because of the use of the reversing gears, high tapping speeds are possible resulting in significantly shorter cycle times compared to conventional tapping.

Extended spindle lengths upon on request.

Designation			Ø d	n _{max} rpm	P _{max} bar	B	E	d1	d2	h	l	l1	l2	l3
GNC6-MMS	ESX12	M3-M6	3-7	4000	10	4	6	19	70	27	-	-	106	13/21
GNC12-MMS	ESX16	M4-M12	3-10	2500	10	5	9	28	87	37	-	-	119	25/45
GNC20-MMS	ESX25	M12-M20	7.1-16	1500	10	8	10	42	100	45	187	175	142	29/42
GNCN6C-ESX12/	ESX12	M3-M6	3-7	4000	-	3.5	6.5	19	70	27	132	125	106	13/21
GNCK6C-ESX12/	ESX12	M3-M6	3-7	4000	50	3.5	6.5	19	70	27	132	125	106	13/21
GNCN12C-ESX16/	ESX16	M4-M12	3-10	2500	-	5	9	28	87	37	153	143	119	25/45
GNCK12C-ESX16/	ESX16	M4-M12	3-10	2500	50	5	9	28	87	37	153	143	119	25/45
GNCN20C-ESX25/	ESX25	M12-M20	7.1-16	1500	-	8	10	42	100	45	187	175	142	29/42
GNCK20C-ESX25/	ESX25	M12-M20	7.1-16	1500	50	8	10	42	100	45	187	175	142	29/42

Weights

Unit
GNCN/GNCK 6 C approx. 1.75 KGS
GNCN/GNCK 12 C approx. 3.10 KGS
GNCN/GNCK 20 C approx. 5.15 KGS
Torque Support
 Depending on design approx. 0.5 – 1.0 KGS
Shank
 Depending on design approx. 0.8 – 3.0 KGS

For inquiries please add:

- machine manufacturer
- machine type
- serial number machine
- spindle location/size
- with/without coolant
- thread size

Attention! The tap must be suitable for the material and the process. Please respect the recommended speed of the tap manufacturers!

Specific machine no. Please state the exact machine model

Collet ESX16-8; Driver BN1716-5; Set contents: wrench, allen key

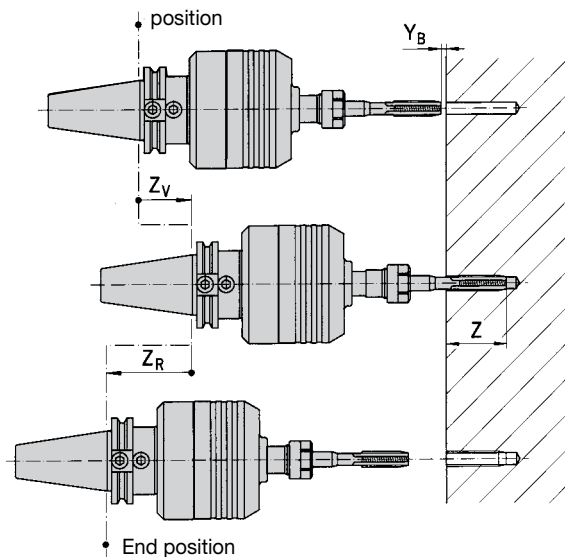
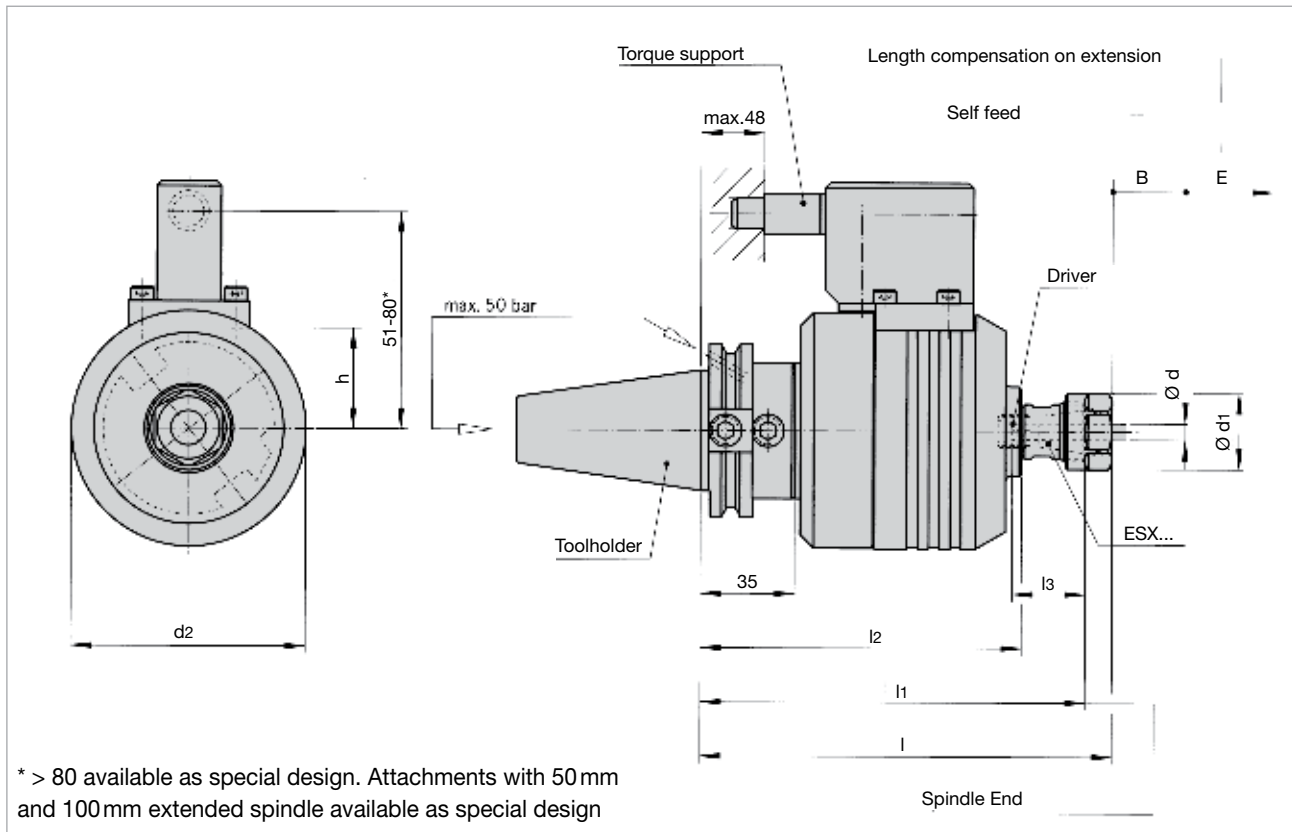

- Z = Tapping depth
- Z_V = Spindle advance
- Z_R = Spindle return
- $Y_{(A, B)}$ = Safety margin
- B = Self feed
- E = Compensation on extension

Programming Example



At the starting position with a selected safety margin Y_B the following equations give:

$$Z_V = Y_B + Z - 0.5 B$$

$$Z_R = Z + E + 0.5 B + 1$$

For tapping operations on machining centres using GNCN/GNCK, the following should be taken into account when programming the machine:

- No change in direction of rotation of the machine spindle, as this is carried out by the GNCN/GNCK
- Feed = 95 – 98% of thread pitch
- No dwelling time
- Varying cutting geometry of the tap
- Self speed
- Compensation on extension after release

Designation		Driver	Square	l3		 Set
GNC6-MMS GNCN6C-ESX12 GNCK6C-ESX12	I	-	2.7-5	13-21	I	GNCK-ESX12
	SAP No.				SAP No.	69831955
	I				I	
	SAP No.				SAP No.	
GNC12-MMS GNCN12C-ESX16 GNCK12C-ESX16	I	BN1716-4	4	27	I	GNCK-ESX16
	SAP No.	6930574			SAP No.	6831954
	I	BN1716-4.5	4.5	28	I	
	SAP No.	6930575			SAP No.	
	I	BN1716-5	4.9-5	29	I	
	SAP No.	6930576			SAP No.	
	I	BN1716-5.6	5.5-5.6	29	I	
	SAP No.	6930577			SAP No.	
	I	BN1716-6.3	6.2-6.3	30	I	
	SAP No.	6930578			SAP No.	
	I	BN1716-6.5	6.5	30	I	
	SAP No.	6930579			SAP No.	
	I	BN1716-6.8	6.8	31	I	
SAP No.	6930581			SAP No.		
GNC20-MMS GNCN20C-ESX25 GNCK20C-ESX25	I	-	<5	29	I	GNCK-ESX25
	SAP No.				SAP No.	6831956
	I	BN1725-5.6	5-5.6	35	I	
	SAP No.	6943252			SAP No.	
	I	BN1725-6.5	6.2-6.5	36	I	
	SAP No.	6943253			SAP No.	
	I	BN1725-7.1	7.1	38	I	
	SAP No.	6941587			SAP No.	
	I	BN1725-8	7-8	38	I	
	SAP No.	6931467			SAP No.	
	I	BN1725-9	8-9	40	I	
	SAP No.	6943834			SAP No.	
	I	BN1725-10	9-10	40	I	
SAP No.	6931468			SAP No.		
I	BN1725-11.2	11.2	42	I		
SAP No.	6943835			SAP No.		
I	BN1725-12	11-12	42	I		
SAP No.	6931469			SAP No.		
						

SYNCHRO CHUCKS

INCREASE TAP TOOL LIFE AND IMPROVE THREAD FORM QUALITY

The Bilz Synchro Chuck was originally developed for tapping applications in automotive engine manufacturing. Today, all manufacturing with tapping operations can benefit by using the Synchro Chuck. The features and design of this product—“Elastomer Damping” and “Precision Pin” construction, allow for excellent tap thread form in *synchronized tapping* applications. If you are tapping holes on CNC equipment, you will want to add the Bilz Synchro Chuck to your tool clamping system.

Maximize your tap life and maximize your thread quality with the Synchro chuck.



VIEW
THE
WEBSITE



Market demands have triggered the development of the new design BILZ synchro chucks. Length pre-setting of the tap position can be completed from both sides of the chuck, the minimum quantity lubrication has been optimized and comes with an absolute leak free sealing system.

The tension and compression length compensation, (+/-0.15 mm) in combination with radial dampening effect compensates small synchronisation errors and torque peaks. Through this defined application compensation the user achieves reduced tap flank wear in combination with considerably less cutting loads which in turn increases tap life thread quality.

The “Elastomer” dampening elements are form-secure, they are also resistant to all coolant substances used in today’s machining centers.

Features:

- Minimum compensation on tension/compression
- SCK1+2, +/-0.15mm; SCK3, +/-0.8mm; SCK4, +/-1.5mm

Advantages:

- Reduction of the pressure on the thread flanks
- Compensation of the synchronisation error
- Damping of length adjustment screw—no damage of screw or tap

Benefits:

- Higher life time of the taps
- Less number of tools required
- Reduced risk of tap breakage
- Better thread quality

Application:

Tapping and roll forming on machines with synchronised feed (speed/feed synchronisation)

Machine Type:

Machining centers, CNC turning and special purpose machines with synchronised feed for the tapping operation

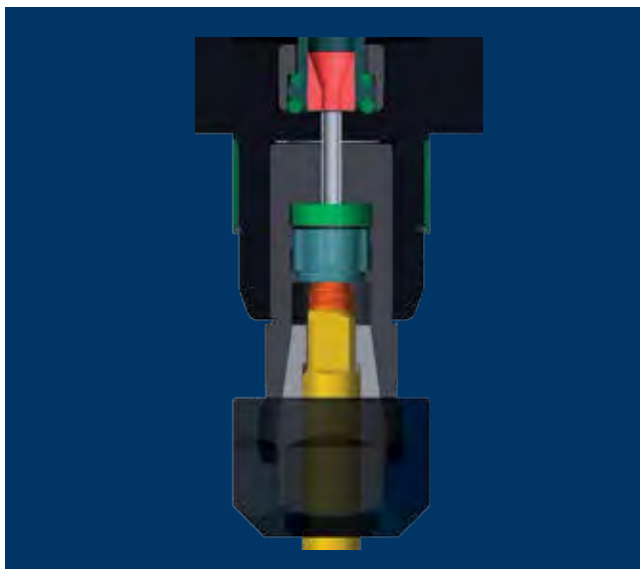

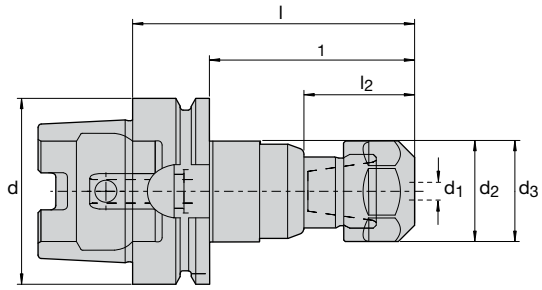

SCK/HSK-ESX													
SAP No.	Designation	Tap Size	Comp	Dimensions (mm)							Collet	Seal	
				d ₁	d ₂	d ₃	d	l	l ₁	l ₂			
Coolant Through													
5010567	SCK1-95.5/HSK-A63-ESX20-BL	M4-M12	+/-0.15	4-12	34	34	63	95.5	69.5	37.5	ER20-GB	DS/ER20	
5013409	SCK1-160/HSK-A63-ESX20-BL	M4-M12	+/-0.15	4-12	34	34	63	160	134	37.5	ER20-GB	DS/ER20	
5012119	SCK1-102/HSK-A100-ESX20-BL	M4-M12	+/-0.15	4-12	34	34	100	102	73	37.5	ER20-GB	DS/ER20	
5011981	SCK2-109/HSK-A63-ESX32-BL	M4-M20	+/-0.15	4-20	50	50	63	109	83	43.5	ER32-GB	DS/ER32	
5012062	SCK2-115.5/HSK-A100-ESX32-BL	M4-M20	+/-0.15	4-20	50	50	100	115.5	86.5	43.5	ER32-GB	DS/ER32	
5017524	SCK3-146.5/HSK-A63-ESX40-BL	M10-M30	+/-0.8	10-22	63	58.5	63	146.5	120.5	50.3	ER40-GB	DS/ER40	
5017526	SCK3-138/HSK-A100-ESX40-BL	M10-M30	+/-0.8	10-22	100	58.5	100	138	109	50.3	ER40-GB	DS/ER40	

See page 15 and 16 for GB Tap Collets
See page 17 for Seal Disc

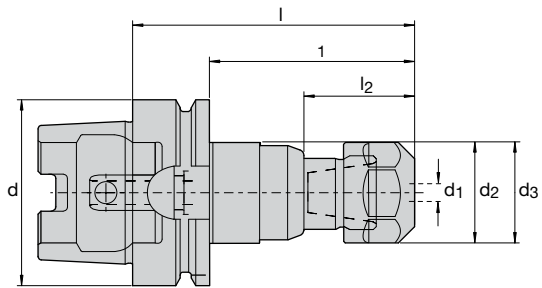
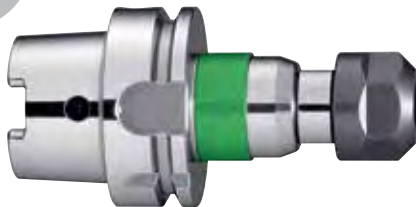

SCK/HSK-A-ESX													
SAP No.	Designation	Tap Size	Comp	Dimensions (mm)							Collet	Seal	
				d ₁	d ₂	d ₃	d	l	l ₁	l ₂			
1-Channel MQL													
5010561	SCK1-95.5/HSK-A63-ESX20-GN	M4-M12	+/-0.15	4.5-11.2	34	34	63	95.5	69.5	37.5	ER20-GB	DS/ER20	
5024594	SCK1-160/HSK-A63-ESX20-GN	M4-M12	+/-0.15	4.5-11.2	34	34	63	160	134	37.5	ER20-GB	DS/ER20	
5012121	SCK1-102/HSK-A100-ESX20-GN	M4-M12	+/-0.15	4.5-11.2	34	34	100	102	73	37.5	ER20-GB	DS/ER20	
5011986	SCK2-109/HSK-A63-ESX32-GN	M4-M20	+/-0.15	4.5-18	50	50	63	109	83	43.5	ER32-GB	DS/ER32	
5024254	SCK2-160/HSK-A63-ESX32-GN	M4-M20	+/-0.15	4.5-18	50	50	63	160	83	43.5	ER32-GB	DS/ER32	
5012066	SCK2-115.5/HSK-A100-ESX32-GN	M4-M20	+/-0.15	4.5-18	50	50	100	115.5	86.5	43.5	ER32-GB	DS/ER32	
5024613	SCK3-146.5/HSK-A63-ESX40-GN	M10-M30	+/-0.8	10-22	63	58.5	63	146.5	120.5	50.3	ER40-GB	DS/ER40	
5024615	SCK3-138/HSK-A100-ESX40-GN	M10-M30	+/-0.8	10-22	100	58.5	100	138	109	50.3	ER40-GB	DS/ER40	

See page 15 and 16 for GB Tap Collets
See page 17 for Seal Disc

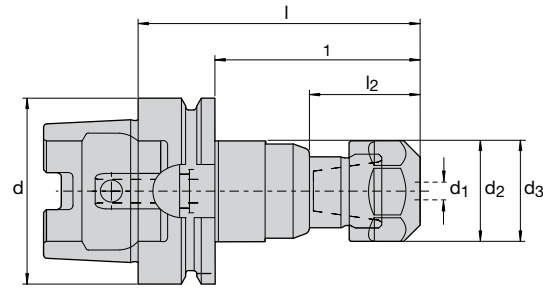

SCK/HSK-ESX												
SAP No.	Designation	Tap Size	Comp	Dimensions (mm)							Collet	Seal
				d ₁	d ₂	d ₃	d	l	l ₁	l ₂		
2-Channel MQL												
5011971	SCK1-B-95.5/HSK-A63-ESX20-GN	M4-M12	+/-0.15	4-12	34	34	63	95.5	69.5	37.5	ER20-GB	DS/ER20
5024976	SCK1-B-160/HSK-A63-ESX20-GN	M4-M12	+/-0.15	4-12	34	34	63	160	134	37.5	ER20-GB	DS/ER20
5012122	SCK1-B-102/HSK-A100-ESX20-GN	M4-M12	+/-0.15	4-12	34	34	100	102	73	37.5	ER20-GB	DS/ER20
5011987	SCK2-B-109/HSK-A63-ESX32-GN	M4-M20	+/-0.15	4-20	50	50	63	109	83	43.5	ER32-GB	DS/ER32
5012067	SCK2-B-115.5/HSK-A100-ESX32-GN	M4-M20	+/-0.15	4-20	50	50	100	115.5	86.5	43.5	ER32-GB	DS/ER32
5052547	SCK3-B-146.5/HSK-A63-ESX40-GN	M10-M30	+/-0.8	10-22	63	58.5	63	146.5	120.5	50.3	ER40-GB	DS/ER40
5016680	SCK3-B-138/HSK-A100-ESX40-GN	M10-M30	+/-0.8	10-22	100	58.5	100	138	109	50.3	ER40-GB	DS/ER40

See [page 15](#) and [16](#) for GB Tap Collets
 See [page 17](#) for Seal Disc

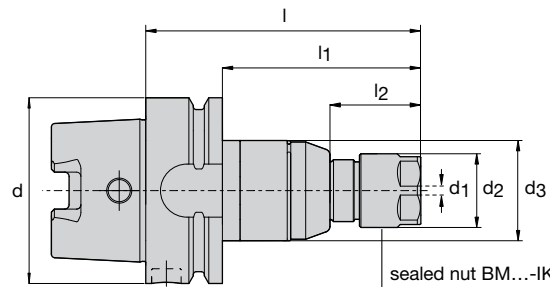
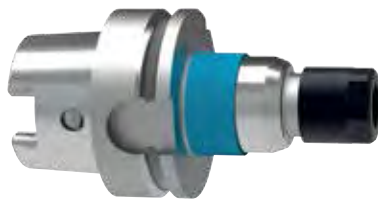

SCK/HSK-BZ												
SAP No.	Designation	Tap Size	Comp	Dimensions (mm)							Collet	Seal
				d ₁	d ₂	d ₃	d	l	l ₁	l ₂		
Coolant Through												
5014929	SCK1-86/HSK-A63-BZ18-BL	M3.5-M14	+/-0,15	3.5-14.0	25	34	63	86	60	28	BZ18	DS/ER20
5017529	SCK1-92.5/HSK-A100-BZ18-BL	M3.5-M14	+/-0,15	3.5-14.0	25	34	100	92.5	63.5	28	BZ18	DS/ER20
5017530	SCK2-104/HSK-A63-BZ25-BL	M10-M20	+/-0,15	10.0-20.0	34	50	63	104	78	38.5	BZ25	DS/ER25
5017531	SCK2-110.5/HSK-A100-BZ25-BL	M10-M20	+/-0,15	10.0-20.0	34	50	100	110.5	81.5	38.5	BZ25	DS/ER25

See [page 15](#) and [16](#) for GB Tap Collets
 See [page 17](#) for Seal Disc

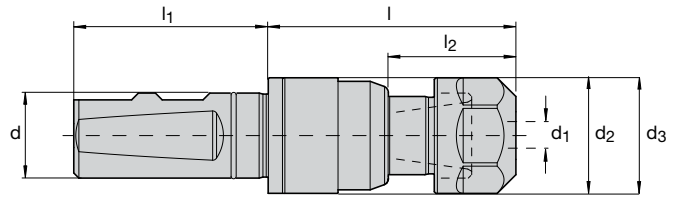

SCK Straight Shank – Coolant Through											
SAP No.	Designation	Tap Size	Comp	Dimensions (mm)						Collet	Seal
				d ₁	d ₂	d ₃	d	l	l ₁		
Metric Shank											
5023361	SCK1-73/W20-ESX20-BL	M4-M12	+/-0.15	4-12	34	34	20	73	57	ER20-GB	DS/ER20
5012220	SCK1-73/W25-ESX20-BL	M4-M12	+/-0.15	4-12	34	34	25	73	57	ER20-GB	DS/ER20
5012283	SCK1-73/MS25-ESX20-BL*	M4-M12	+/-0.15	4-12	34	34	25	73	57	ER20-GB	DS/ER20
5012276	SCK2-87.5/W25-ESX32-BL	M4-M20	+/-0.15	4-20	50	50	25	87.5	57	ER32-GB	DS/ER32
5012284	SCK2-87.5/MS25-ESX32-BL*	M4-M20	+/-0.15	4-20	50	50	25	87.5	57	ER32-GB	DS/ER32
5017528	SCK3-113.5/W32-ESX40-BL	M10-M30	+/-0.8	10-22.0	63	58.5	32	113.5	61	ER40-GB	DS/ER40
Inch Shank											
5020050	SCK1-73/M25.4-ESX20-BL	M4-M12	+/-0.15	4.5-11.2	34	34	25.4	73	50.8	ER20-GB	DS/ER20
5013247	SCK2-87.5/M25.4-ESX32-BL	M4-M20	+/-0.15	4.5-18	50	50	25.4	87.5	50.8	ER32-GB	DS/ER32

See page 15 and 16 for GB Tap Collets

See page 17 for Seal Disc

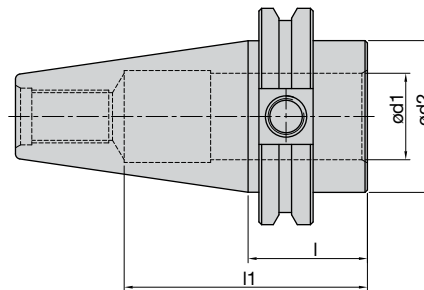

Holders for Straight Shank Synchro Chucks							
SAP No.	Catalog No.	Description	Dimensions (mm)				
			d ₁	d ₂	l ₁	l	
12934216	12934216	CAT40 w/1 Bore	1.0	45	68.5	1.375	
12934218	12934218	CAT50 w/1 Bore	1.0	70	84.5	1.375	
12934219	12934219	CAT50 w/1.5 Bore	1.5	70	84.5	1.375	
12934221	12934221	BT40 w/1 Bore	1.0	45	68.5	1.062	
12934223	12934223	BT50 w/1 Bore	1.0	70	84.5	1.875	
12934880	12934880	BT50 w/1.5 Bore	1.5	70	84.5	1.875	
6831412	WA25/A126/B40*	DIN-40 Taper 25mm Bore	25mm	50	54.0	1.378	
6831414	WA25/A126/B50*	DIN-50 Taper 25mm Bore	25mm	70	54.0	1.378	

*For coolant thru the flange, use with MS25 shank tools.

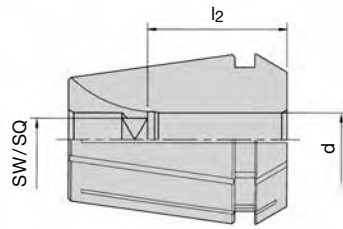

ER-GB – Inch				Catalog No.					
Shank d (inch)	Square SW (inch)	l ₂ (mm)	Pipe Tap	ER 11-GB	ER 16-GB	ER 20-GB	ER 25-GB	ER 32-GB	ER 40-GB
0.141	0.110	18		1411.03585	1416.03585				
0.168	0.131	18			1416.04275	1420.04275	1425.04275	1432.04275	
0.194	0.152	18			1416.04935	1420.04935	1425.04935	1432.04935	
0.22	0.165	18			1416.05595	1420.05595	1425.05595	1432.05595	
0.255	0.191	18			1416.06485	1420.06485	1425.06485	1432.06485	1440.06485
0.318	0.238	22			1416.08085	1420.08085	1425.08085	1432.08085	1440.08085
0.323	0.242	22				1420.08215	1425.08215	1432.08215	1440.08215
0.367	0.275	22				1420.09325	1425.09325	1432.09325	1440.09325
0.381	0.286	22				1420.09685	1425.09685	1432.09685	1440.09685
0.429	0.322	25					1425.10905	1432.10905	1440.10905
0.437	0.328	25	3				1425.11104	1432.11104	1440.11104
0.48	0.360	25					1425.12195	1432.12195	1440.12195
0.542	0.406	25						1432.13775	1440.13775
0.562	0.421	25	3					1432.14274	1440.14274
0.59	0.442	25						1432.14995	1440.14995
0.652	0.489	25						1432.16565	1440.16565
0.687	0.515	25	3						1440.17454
0.697	0.523	25							1440.17705
0.70	0.531	25	3						1440.17784
0.76	0.570	25							1440.19305
0.80	0.600	28							1440.20325

ER-GB | Collets
Square Drive Tap Collet (DIN)

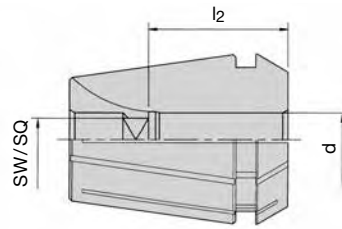

ER-GB – Metric									
Shank d (inch)	Square SW (inch)	l ₂ (mm)	STD	Catalog No.					
				ER 11-GB	ER 16-GB	ER 20-GB	ER 25-GB	ER 32-GB	ER 40-GB
2.8	2.1	12	DIN	1411.02800					
3.5	2.7	14	DIN	1411.03500					
4	3	14	DIN	1411.04000					
4	3.15/3.2	18	ISO, JIS		1416.04002	1420.04002	1425.04002	1432.04002	
4.5	3.4	18	DIN	1411.04500	1416.04500	1420.04500	1425.04500	1432.04500	
5	4	18	ISO, JIS		1416.05002	1420.05002	1425.05002	1432.05002	
5.5	4.3	18	DIN		1416.05500	1420.05500	1425.05500	1432.05500	
5.5	4.5	18	JIS		1416.05501	1420.05501	1425.05501	1432.05501	
6	4.5	18	JIS		1416.06001	1420.06001	1425.06001	1432.06001	1440.06001
6	4.9	18	DIN	1411.06000	1416.06000	1420.06000	1425.06000	1432.06000	1440.06000
6.2	5	18	JIS		1416.06201	1420.06201	1425.06201	1432.06201	1440.06201
6.3	5	18	ISO		1416.06302	1420.06302	1425.06302	1432.06302	1440.06302
7	5.5	18	DIN, JIS		1416.07000	1420.07000	1425.07000	1432.07000	1440.07000
7.1	5.6	18	ISO		1416.07102	1420.07102	1425.07102	1432.07102	1440.07102
8	6.2/6.3	22	DIN, ISO		1416.08000	1420.08000	1425.08000	1432.08000	1440.08000
8.5	6.5	22	JIS		1416.08501	1420.08501	1425.08501	1432.08501	1440.08501
9	7.0/7.1	22	DIN, ISO		1416.09000	1420.09000	1425.09000	1432.09000	1440.09000
10	8	25	DIN, ISO			1420.10000	1425.10000	1432.10000	1440.10000
10.5	8	25	JIS			1420.10501	1425.10501	1432.10501	1440.10501
11	9	25	DIN			1420.11000	1425.11000	1432.11000	1440.11000
11.2	9	25	ISO			1420.11202	1425.11202	1432.11202	1440.11202
12	9	25	DIN				1425.12000	1432.12000	1440.12000
12.5	10	25	ISO, JIS				1425.12502	1432.12502	1440.12502
14	11.0/11.2	25	DIN, ISO, JIS				1425.14000	1432.14000	1440.14000
15	12	25	JIS				1425.15001	1432.15001	1440.15001
16	12	25	DIN				1425.16000	1432.16000	1440.16000
17	13	25	JIS					1432.17001	1440.17001
18	14.0/14.5	25	DIN, ISO					1432.18000	1440.18000
20	16	28	DIN, ISO					1432.20000	1440.20000
22	18	28	DIN						1440.22000

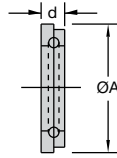

Sealing Discs						
Sealing Capacity (mm)	(inch)	(inch)	Catalog No.			
			DS/ER 16	DS/ER 20	DS/ER 25	DS/ER 32
3.00...2.50	0.1181...0.0984		3916.00300	3920.00300	3925.00300	3932.00300
3.50...3.00	0.1378...0.1181	1/8	3916.00350	3920.00350	3925.00350	3932.00350
4.00...3.50	0.1575...0.1378	5/32	3916.00400	3920.00400	3925.00400	3932.00400
4.50...4.00	0.1772...0.1575		3916.00450	3920.00450	3925.00450	3932.00450
5.00...4.50	0.1969...0.1772	3/16	3916.00500	3920.00500	3925.00500	3932.00500
5.50...5.00	0.2165...0.1969		3916.00550	3920.00550	3925.00550	3932.00550
6.00...5.50	0.2362...0.216	7/32	3916.00600	3920.00600	3925.00600	3932.00600
6.50...6.00	0.2559...0.2362	1/4	3916.00650	3920.00650	3925.00650	3932.00650
7.00...6.50	0.2756...0.2559		3916.00700	3920.00700	3925.00700	3932.00700
7.50...7.00	0.2953...0.2756	9/32	3916.00750	3920.00750	3925.00750	3932.00750
8.00...7.50	0.3150...0.2953	5/16	3916.00800	3920.00800	3925.00800	3932.00800
8.50...8.00	0.3347...0.3150		3916.00850	3920.00850	3925.00850	3932.00850
9.00...8.50	0.3543...0.3347	11/32	3916.00900	3920.00900	3925.00900	3932.00900
9.50...9.00	0.3740...0.3543	3/8	3916.00950	3920.00950	3925.00950	3932.00950
10.00...9.50	0.3937...0.3740		3916.01000	3920.01000	3925.01000	3932.01000
10.50...10.00	0.4134...0.3937	13/32		3920.01050	3925.01050	3932.01050
11.00...10.50	0.4330...0.4134			3920.01100	3925.01100	3932.01100
11.50...11.00	0.4528...0.4330	7/16		3920.01150	3925.01150	3932.01150
12.00...11.50	0.4724...0.4528	15/32		3920.01200	3925.01200	3932.01200
12.50...12.00	0.4921...0.4724			3920.01250	3925.01250	3932.01250
13.00...12.50	0.5118...0.4921	1/2		3920.01300	3925.01300	3932.01300
13.50...13.00	0.5315...0.5118	17/32			3925.01350	3932.01350
14.00...13.50	0.5512...0.5315				3925.01400	3932.01400
14.50...14.00	0.5709...0.5512	9/16			3925.01450	3932.01450
15.00...14.50	0.5905...0.5709				3925.01500	3932.01500
15.50...15.00	0.6102...0.5905	19/32			3925.01550	3932.01550
16.00...15.50	0.6300...0.6102	5/8			3925.01600	3932.01600
16.50...16.00	0.6496...0.6300					3932.01650
17.00...16.50	0.6693...0.6496	21/32				3932.01700
17.50...17.00	0.6890...0.6693	11/16				3932.01750
18.00...17.50	0.7087...0.6890					3932.01800
18.50...18.00	0.7284...0.7087	23/32				3932.01850
19.00...18.50	0.7480...0.7284					3932.01900
19.50...19.00	0.7677...0.7480	3/4				3932.01950
20.00...19.50	0.7874...0.7677	25/32				3932.02000

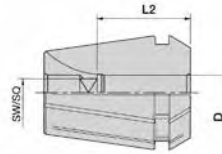

ER Single Angle Collets					
Catalog No.	Description	Catalog No.	Description	Catalog No.	Description
1111.01000	ER 11 1.0mm	1116.04001	ER 16-UP 4.0mm	1120.04500	ER 20 4.5mm
1111.01001	ER 11-UP 1.0mm	1116.04500	ER 16 4.5mm	1120.04501	ER 20-UP 4.5mm
1111.01500	ER 11 1.5mm	1116.04501	ER 16-UP 4.5mm	1120.04762	ER 20 3/16
1111.01501	ER 11-UP 1.5mm	1116.04762	ER 16 3/16	1120.04763	ER 20-UP 3/16
1111.01592	ER 11 1/16	1116.04763	ER 16-UP 3/16	1120.05000	ER 20 5.0mm
1111.02000	ER 11 2.0mm	1116.05000	ER 16 5.0mm	1120.05001	ER 20-UP 5.0mm
1111.02001	ER 11-UP 2.0mm	1116.05001	ER 16-UP 5.0mm	1120.05500	ER 20 5.5mm
1111.02382	ER 11 3/32	1116.05500	ER 16 5.5mm	1120.05501	ER 20-UP 5.5mm
1111.02500	ER 11 2.5mm	1116.05501	ER 16-UP 5.5mm	1120.06000	ER 20 6.0mm
1111.02501	ER 11-UP 2.5mm	1116.05562	ER 16 7/32	1120.06001	ER 20-UP 6.0mm
1111.03000	ER 11 3.0mm	1116.05563	ER 16-UP 7/32	1120.06352	ER 20 1/4
1111.03001	ER 11-UP 3.0mm	1116.06000	ER 16 6.0mm	1120.06353	ER 20-UP 1/4
1111.03182	ER 11 1/8	1116.06001	ER 16-UP 6.0mm	1120.06500	ER 20 6.5mm
1111.03183	ER 11-UP 1/8	1116.06352	ER 16 1/4	1120.06501	ER 20-UP 6.5mm
1111.03500	ER 11 3.5mm	1116.06353	ER 16-UP 1/4	1120.07000	ER 20 7.0mm
1111.03501	ER 11-UP 3.5mm	1116.06500	ER 16 6.5mm	1120.07001	ER 20-UP 7.0mm
1111.03972	ER 11 5/32	1116.06501	ER 16-UP 6.5mm	1120.07500	ER 20 7.5mm
1111.04000	ER 11 4.0mm	1116.07000	ER 16 7.0mm	1120.07501	ER 20-UP 7.5mm
1111.04001	ER 11-UP 4.0mm	1116.07001	ER 16-UP 7.0mm	1120.07942	ER 20 5/16
1111.04500	ER 11 4.5mm	1116.07142	ER 16 9/32	1120.07943	ER 20-UP 5/16
1111.04501	ER 11-UP 4.5mm	1116.07143	ER 16-UP 9/32	1120.08000	ER 20 8.0mm
1111.04762	ER 11 3/16	1116.07500	ER 16 7.5mm	1120.08001	ER 20-UP 8.0mm
1111.04763	ER 11-UP 3/16	1116.07501	ER 16-UP 7.5mm	1120.08500	ER 20 8.5mm
1111.05000	ER 11 5.0mm	1116.07942	ER 16 5/16	1120.08501	ER 20-UP 8.5mm
1111.05001	ER 11-UP 5.0mm	1116.07943	ER 16-UP 5/16	1120.09000	ER 20 9.0mm
1111.05500	ER 11 5.5mm	1116.08000	ER 16 8.0mm	1120.09001	ER 20-UP 9.0mm
1111.05501	ER 11-UP 5.5mm	1116.08001	ER 16-UP 8.0mm	1120.09500	ER 20 9.5mm
1111.05562	ER 11 7/32	1116.08500	ER 16 8.5mm	1120.09501	ER 20-UP 9.5mm
1111.06000	ER 11 6.0mm	1116.08501	ER 16-UP 8.5mm	1120.09532	ER 20 3/8
1111.06001	ER 11-UP 6.0mm	1116.08732	ER 16 11/32	1120.09533	ER 20-UP 3/8
1111.06352	ER 11 1/4	1116.08733	ER 16-UP 11/32	1120.10000	ER 20 10.0mm
1111.06353	ER 11-UP 1/4	1116.09000	ER 16 9.0mm	1120.10001	ER 20-UP 10.0mm
1111.06500	ER 11 6.5mm	1116.09001	ER 16-UP 9.0mm	1120.10500	ER 20 10.5mm
1111.06501	ER 11-UP 6.5mm	1116.09500	ER 16 9.5mm	1120.10501	ER 20-UP 10.5mm
1111.07000	ER 11 7.0mm	1116.09501	ER 16-UP 9.5mm	1120.11000	ER 20 11.0mm
1111.07001	ER 11-UP 7.0mm	1116.09532	ER 16 3/8	1120.11001	ER 20-UP 11.0mm
1116.01000	ER 16 1.0mm	1116.09533	ER 16-UP 3/8	1120.11112	ER 20 7/16
1116.01001	ER 16-UP 1.0mm	1116.10000	ER 16 10.0mm	1120.11113	ER 20-UP 7/16
1116.01500	ER 16 1.5mm	1116.10001	ER 16-UP 10.0mm	1120.11500	ER 20 11.5mm
1116.01501	ER 16-UP 1.5mm	1116.10322	ER 16 13/32	1120.11501	ER 20-UP 11.5mm
1116.01592	ER 16 1/16	1116.10323	ER 16-UP 13/32	1120.12000	ER 20 12.0mm
1116.01593	ER 16-UP 1/16	1120.01000	ER 20 1.0mm	1120.12001	ER 20-UP 12.0mm
1116.02000	ER 16 2.0mm	1120.01001	ER 20-UP 1.0mm	1120.12500	ER 20 12.5mm
1116.02001	ER 16-UP 2.0mm	1120.01500	ER 20 1.5mm	1120.12501	ER 20-UP 12.5mm
1116.02382	ER 16 3/32	1120.01501	ER 20-UP 1.5mm	1120.12702	ER 20 1/2
1116.02383	ER 16-UP 3/32	1120.02000	ER 20 2.0mm	1120.12703	ER 20-UP 1/2
1116.02500	ER 16 2.5mm	1120.02001	ER 20-UP 2.0mm	1120.13000	ER 20 13.0mm
1116.02501	ER 16-UP 2.5mm	1120.02500	ER 20 2.5mm	1120.13001	ER 20-UP 13.0mm
1116.03000	ER 16 3.0mm	1120.02501	ER 20-UP 2.5mm	1125.01000	ER 25 1.0mm
1116.03001	ER 16-UP 3.0mm	1120.03000	ER 20 3.0mm	1125.01001	ER 25-UP 1.0mm
1116.03182	ER 16 1/8	1120.03001	ER 20-UP 3.0mm	1125.01500	ER 25 1.5mm
1116.03183	ER 16-UP 1/8	1120.03182	ER 20 1/8	1125.01501	ER 25-UP 1.5mm
1116.03500	ER 16 3.5mm	1120.03183	ER 20-UP 1/8	1125.02000	ER 25 2.0mm
1116.03501	ER 16-UP 3.5mm	1120.03500	ER 20 3.5mm	1125.02001	ER 25-UP 2.0mm
1116.03972	ER 16 5/32	1120.03501	ER 20-UP 3.5mm	1125.02500	ER 25 2.5mm
1116.03973	ER 16-UP 5/32	1120.04000	ER 20 4.0mm	1125.02501	ER 25-UP 2.5mm
1116.04000	ER 16 4.0mm	1120.04001	ER 20-UP 4.0mm	1125.03000	ER 25 3.0mm

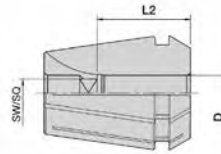

ER Single Angle Collets

Catalog No.	Description	Catalog No.	Description	Catalog No.	Description
1125.03001	ER 25-UP 3.0mm	1125.14000	ER 25 14.0mm	1132.10001	ER 32-UP 10.0mm
1125.03182	ER 25 1/8	1125.14001	ER 25-UP 14.0mm	1132.10500	ER 32 10.5mm
1125.03183	ER 25-UP 1/8	1125.14292	ER 25 9/16	1132.10501	ER 32-UP 10.5mm
1125.03500	ER 25 3.5mm	1125.14293	ER 25-UP 9/16	1132.11000	ER 32 11.0mm
1125.03501	ER 25-UP 3.5mm	1125.14500	ER 25 14.5mm	1132.11001	ER 32-UP 11.0mm
1125.04000	ER 25 4.0mm	1125.14501	ER 25-UP 14.5mm	1132.11112	ER 32 7/16
1125.04001	ER 25-UP 4.0mm	1125.15000	ER 25 15.0mm	1132.11113	ER 32-UP 7/16
1125.04500	ER 25 4.5mm	1125.15001	ER 25-UP 15.0mm	1132.11500	ER 32 11.5mm
1125.04501	ER 25-UP 4.5mm	1125.15500	ER 25 15.5mm	1132.11501	ER 32-UP 11.5mm
1125.04762	ER 25 3/16	1125.15501	ER 25-UP 15.5mm	1132.12000	ER 32 12.0mm
1125.04763	ER 25-UP 3/16	1125.15882	ER 25 5/8	1132.12001	ER 32-UP 12.0mm
1125.05000	ER 25 5.0mm	1125.15883	ER 25-UP 5/8	1132.12500	ER 32 12.5mm
1125.05001	ER 25-UP 5.0mm	1125.16000	ER 25 16.0mm	1132.12501	ER 32-UP 12.5mm
1125.05500	ER 25 5.5mm	1125.16001	ER 25-UP 16.0mm	1132.12702	ER 32 1/2
1125.05501	ER 25-UP 5.5mm	1132.02000	ER 32 2.0mm	1132.12703	ER 32-UP 1/2
1125.06000	ER 25 6.0mm	1132.02001	ER 32-UP 2.0mm	1132.13000	ER 32 13.0mm
1125.06001	ER 25-UP 6mm	1132.02500	ER 32 2.5mm	1132.13001	ER 32-UP 13.0mm
1125.06352	ER 25 1/4	1132.02501	ER 32-UP 2.5mm	1132.13500	ER 32 13.5mm
1125.06353	ER 25-UP 1/4	1132.03000	ER 32 3.0mm	1132.13501	ER 32-UP 13.5mm
1125.06500	ER 25 6.5mm	1132.03001	ER 32-UP 3.0mm	1132.14000	ER 32 14.0mm
1125.06501	ER 25-UP 6.5mm	1132.03182	ER 32 1/8	1132.14001	ER 32-UP 14.0mm
1125.07000	ER 25 7.0mm	1132.03183	ER 32-UP 1/8	1132.14292	ER 32 9/16
1125.07001	ER 25-UP 7.0mm	1132.03500	ER 32 3.5mm	1132.14293	ER 32-UP 9/16
1125.07500	ER 25 7.5mm	1132.03501	ER 32-UP 3.5mm	1132.14500	ER 32 14.5mm
1125.07501	ER 25-UP 7.5mm	1132.04000	ER 32 4.0mm	1132.14501	ER 32-UP 14.5mm
1125.07942	ER 25 5/16	1132.04001	ER 32-UP 4.0mm	1132.15000	ER 32 15.0mm
1125.07943	ER 25-UP 5/16	1132.04500	ER 32 4.5mm	1132.15001	ER 32-UP 15.0mm
1125.08000	ER 25 8.0mm	1132.04501	ER 32-UP 4.5mm	1132.15500	ER 32 15.5mm
1125.08001	ER 25-UP 8mm	1132.04762	ER 32 3/16	1132.15501	ER 32-UP 15.5mm
1125.08500	ER 25 8.5mm	1132.04763	ER 32-UP 3/16	1132.15882	ER 32 5/8
1125.08501	ER 25-UP 8.5mm	1132.05000	ER 32 5.0mm	1132.15883	ER 32-UP 5/8
1125.09000	ER 25 9.0mm	1132.05001	ER 32-UP 5.0mm	1132.16000	ER 32 16.0mm
1125.09001	ER 25-UP 9mm	1132.05500	ER 32 5.5mm	1132.16001	ER 32-UP 16.0mm
1125.09500	ER 25 9.5mm	1132.05501	ER 32-UP 5.5mm	1132.16500	ER 32 16.5mm
1125.09501	ER 25-UP 9.5mm	1132.06000	ER 32 6.0mm	1132.16501	ER 32-UP 16.5mm
1125.09532	ER 25 3/8	1132.06001	ER 32-UP 6.0mm	1132.17000	ER 32 17.0mm
1125.09533	ER 25-UP 3/8	1132.06352	ER 32 1/4	1132.17001	ER 32-UP 17.0mm
1125.10000	ER 25 10.0mm	1132.06353	ER 32-UP 1/4	1132.17462	ER 32 11/16
1125.10001	ER 25-UP 10.0mm	1132.06500	ER 32 6.5mm	1132.17463	ER 32-UP 11/16
1125.10500	ER 25 10.5mm	1132.06501	ER 32-UP 6.5mm	1132.17500	ER 32 17.5mm
1125.10501	ER 25-UP 10.5mm	1132.07000	ER 32 7.0mm	1132.17501	ER 32-UP 17.5mm
1125.11000	ER 25 11.0mm	1132.07001	ER 32-UP 7.0mm	1132.18000	ER 32 18.0mm
1125.11001	ER 25-UP 11.0mm	1132.07500	ER 32 7.5mm	1132.18001	ER 32-UP 18.0mm
1125.11112	ER 25 7/16	1132.07501	ER 32-UP 7.5mm	1132.18500	ER 32 18.5mm
1125.11113	ER 25-UP 7/16	1132.07942	ER 32 5/16	1132.18501	ER 32-UP 18.5mm
1125.11500	ER 25 11.5mm	1132.07943	ER 32-UP 5/16	1132.19000	ER 32 19.0mm
1125.11501	ER 25-UP 11.5mm	1132.08000	ER 32 8.0mm	1132.19001	ER 32-UP 19.0mm
1125.12000	ER 25 12.0mm	1132.08001	ER 32-UP 8.0mm	1132.19052	ER 32 3/4
1125.12001	ER 25-UP 12.0mm	1132.08500	ER 32 8.5mm	1132.19053	ER 32-UP 3/4
1125.12500	ER 25 12.5mm	1132.08501	ER 32-UP 8.5mm	1132.19500	ER 32 19.5mm
1125.12501	ER 25-UP 12.5mm	1132.09000	ER 32 9.0mm	1132.19501	ER 32-UP 19.5mm
1125.12702	ER 25 1/2	1132.09001	ER 32-UP 9.0mm	1132.20000	ER 32 20.0mm
1125.12703	ER 25-UP 1/2	1132.09500	ER 32 9.5mm	1132.20001	ER 32-UP 20.0mm
1125.13000	ER 25 13.0mm	1132.09501	ER 32-UP 9.5mm	1132.20642	ER 32 13/16
1125.13001	ER 25-UP 13.0mm	1132.09532	ER 32 3/8	1132.20643	ER 32-UP 13/16
1125.13500	ER 25 13.5mm	1132.09533	ER 32-UP 3/8		
1125.13501	ER 25-UP 13.5mm	1132.10000	ER 32 10.0mm		

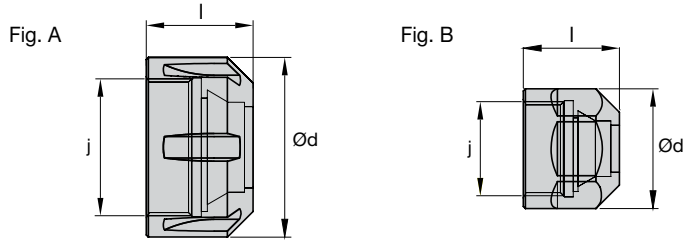

Collet Nuts							
Type	Catalog No.	Dimensions (mm)					Figure
		d	l	j	l ₁	l ₂	
Non-Coolant Style							
Hi-Q/ER 11	3411.00000	19	11.3	M 14 x .75	4.9 ... 6.6	–	B
Hi-Q/ER 16	3416.00000	28	17.5	M 22 x 1.5	7.0 ... 10.5	–	B
Hi-Q/ER 20	3420.00000	34	19	M25 x 1.5	8.0 ... 11.5	–	B
Hi-Q/ER 25	3425.00000	42	20	M 32 x 1.5	8.5 ... 12.0	–	A
Hi-Q/ER 32	3432.00000	50	22.5	M 40 x 1.5	9.5 ... 13.0	–	A
Coolant Style							
Hi-Q/ERC 16	3416.20000	28	22.5	M 22 x 1.5	12.0 ... 15.5	5	B
Hi-Q/ERC 20	3420.20000	34	24	M 25 x 1.5	13.0 ... 16.5	5	B
Hi-Q/ERC 25	3425.20000	42	25	M 32 x 1.5	13.5 ... 17.0	5	A
Hi-Q/ERC 32	3432.20000	50	27.5	M 40 x 1.5	14.5 ... 18.0	5	A

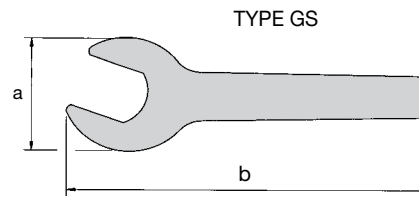
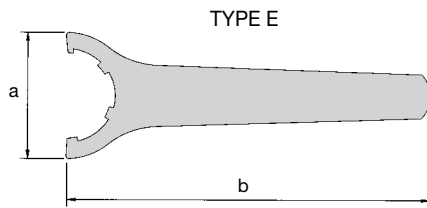

Spanners									
Spanners	Part No.	Size	a (mm)	b (mm)	Hi-Q/ER	Hi-Q/ERC	Hi-Q/ERB	Hi-Q/ERBC	CM/ER
TYPE E									
E 16	7111.16000	ER 16	50.0	160					✓
E 20	7111.20000	ER 20	55.0	180					✓
E 25	7111.25000	ER 25	65.0	210	✓	✓	✓	✓	
E 32	7111.32000	ER 32	75.0	250	✓	✓	✓	✓	
E 40	7111.40000	ER 40	90.0	290	✓	✓	✓	✓	
E 50	7111.50000	ER 50	110.0	350	✓		✓		
TYPE GS									
GS 17	7112.11010	ER 11	17.0	95	✓	✓			
GS 25	7112.16010	ER 16	25.0	144	✓	✓	✓	✓	
GS 30	7112.20010	ER 20	30.0	172	✓	✓	✓	✓	

Torque Wrenches					
Type	Catalog No.	(Nm)	Range (ft-lbs)	l ₁ (mm)	l ₁ (inch)
Micro	7150.05050	5...50	3.7...37	335	13.2
Small	8020.08060	8...60	5.9...44	300	11.8
Medium	8020.20100	20...100	14.8...73.8	340	13.4
Large	8020.60300	60...300	44.3...221	545	21.5

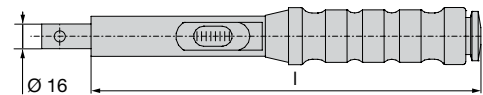

Matching Wrench Heads							
Wrench Heads	Catalog No.	Size	Dimensions (mm)				
			a	b	Hi-Q/ER	Hi-Q/ERC	CM/ER
TYPE A-E							
A-E 16	7151.16000	ER 16	50	62			3
A-E 20	7151.20000	ER 20	55	62			3
A-E 25	7151.25000	ER 25	65	72	3	3	
A-E 32	7151.32000	ER 32	75	72	3	3	
A-E 40	7151.40000	ER 40	90	82	3	3	
A-E 50	7151.50000	ER 50	110	93	3		
HEX TYPE							
A-E11P	7152.11010	ER 11	32	61	3	3	
A-E16P	7152.16010	ER 16	44	71	3	3	
A-E20P	7152.20010	ER 20	52	81	3	3	

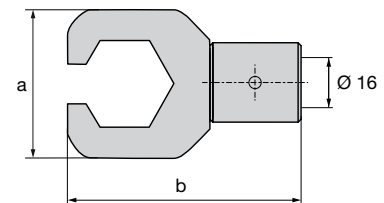
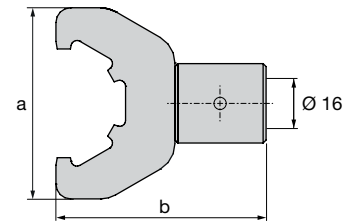
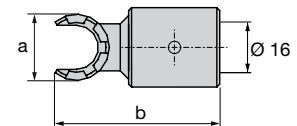

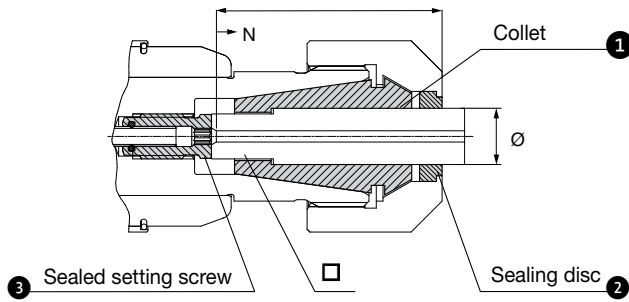

N = Adjustment
 l_2 = Insert depth
 \varnothing = Shank diameter
 = Drive square

Flat Screw

SCK110C-4.5x3.4	5013780	SCK210C-7x5.5	5013825	SCK310C-10x8	5016661
SCK110C-5x4	5013781	SCK210C-8x6.2	5013826	SCK310C-11x9	5016662
SCK110C-6x4.9	5012783	SCK210C-9x7	5012864	SCK310C-11x9	5016662
SCK110C-7x5.5	5012792	SCK210C-10x8	5012868	SCK310C-14x11	5016663
SCK110C-8x6.2	5012793	SCK210C-11x9	5012869	SCK310C-16x12	5016664
SCK110C-9x7	5012796	SCK210C-11x9	5012869	SCK310C-18x14.5	5016665
SCK110C-10x8	5012809	SCK210C-14x11	5012870	SCK310C-20x16	5016666
SCK110C-11x9	5013782	SCK210C-16x12	5012871	SCK310C-22x18	5016667
SCK210C-6x4.9	5013824	SCK210C-18x14.5	5013789		

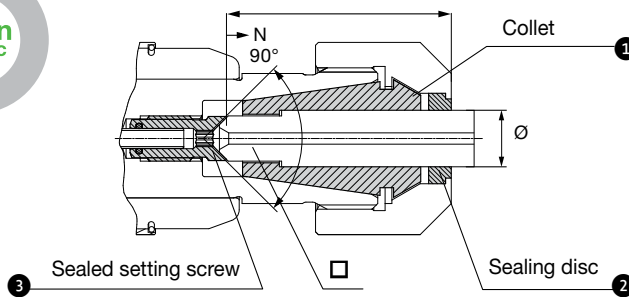







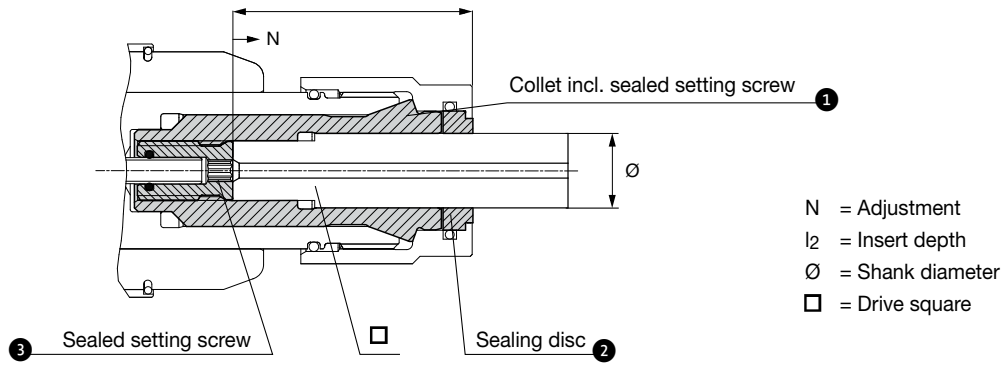





N = Adjustment
 l_2 = Insert depth
 \varnothing = Shank diameter
 = Drive square

Cone Screw

SCK110B-4.5x3.4	5047555	SCK210B-9x7	5010674	SCK310B-11x9	5016701
SCK110B-5x4	5010618	SCK210B-10x8	5010679	SCK310B-14x11	5016702
SCK110B-6x4.9	5010622	SCK210B-11x9	5010680	SCK310B-16x12	5016703
SCK110B-7x5.5	5010623	SCK210B-11x9	5010680	SCK310B-18x14.5	5016704
SCK110B-8x6.2	5010626	SCK210B-14x11	5010682	SCK310B-20x16	5016705
SCK110B-9x7	5010628	SCK210B-16x12	5010683	SCK310B-22x18	5016706
SCK110B-10x8	5010646	SCK310B-10x8	5016699		
SCK110C-11x9	5010649	SCK310B-11x9	5016701		



SPE-BZ Clamping Unit					Clamping Unit BZ Version C			consisting of:					
Designation/ SAP No.	SCK.../BZ...		L ₂	N									
								Ø x □			1	2	3
SPE4.5x3.4C-BZ18 5025987	SCK1/BZ18		27	2				BZK18C-4.5x3.4	DS/ER20-4.5	SCK110C-BZ18-4.5x3.4			
5025987								5025978	6948386	5025981			
SPE5x4C-BZ18 5025986								5.0 x 4.0	28	3	BZK18C-5x4	DS/ER20-5	SCK110C-BZ18-5x4
5025986								5025977	6953236		5025980		
SPE6x4.9C-BZ18 5012926								6.0 x 4.9	29		BZK18C-6x4.9	DS/ER20-6	SCK110C-BZ18-6x4.9
5012926								5012934	6943901		5012939		
SPE7x5.5C-BZ18 5012927								7.0 x 5.5	29		BZK18C-7x5.5	DS/ER20-7	SCK110C-BZ18-7x5.5
5012927								5012935	6950178		5012940		
SPE8x6.2C-BZ18 5012928								8.0 x 6.2	30		BZK18C-8x6.2	DS/ER20-8	SCK110C-BZ18-8x6.2
5012928								5012936	6946991		5012941		
SPE9x7C-BZ18 5012929	9.0 x 7.0	31	BZK18C-9x7	DS/ER20-9	SCK110C-BZ18-9x7								
5012929	5012937	6947339	5012942										
SPE10x8C-BZ18 5012930	10.0 x 8.0	32	BZK18C-10x8	DS/ER20-10	SCK110C-BZ18-10x8								
5012930	5012938	6931347	5012943										
SPE11x9C-BZ18 5026031	11.0 x 9.0	33	BZK18C-11x9	DS/ER20-11	SCK110C-BZ18-11x9								
5026031	5026027	6944294	5026028										
SPE9x7C-BZ25 5029319	SCK2/BZ25		40	3				BZK25C-9x7	DS/ER25-9	SCK210C-BZ25-9x7			
5029319								5029318	6941679	5029317			
SPE10x8C-BZ25 5029322								10.0 x 8.0	41	BZK25C-10x8	DS/ER25-10	SCK210C-BZ25-10x8	
5029322								5029328	6943423	5029340			
SPE11x9C-BZ25 5029323								11.0 x 9.0	42	BZK25C-11x9	DS/ER25-11	SCK210C-BZ25-11x9	
5029323								5029329		6943534	5029341		
SPE12x9C-BZ25 5029324								12.0 x 9.0	45	BZK25C-12x9	DS/ER25-12	SCK210C-BZ25-11x9	
5029324								5029330		6943424	5029341		
SPE14x11C-BZ25 5029325								14.0 x 11.0		BZK25C-14x11	DS/ER25-14	SCK210C-BZ25-14x11	
5029325								5029331		6943342	5029343		
SPE16x12C-BZ25 5029326	16.0 x 12.0	BZK25C-16x12	DS/ER25-16	SCK210C-BZ25-16x12									
5029326	5029332	6943422	5029344										
SPE18x14.5C-BZ25* 5029327	18.0 x 14.5	BZK25C-18x14.5	DS/BZ25-18	SCK210C-BZ25-18x14.5									
5029327	5029333	9088550	5029345										

* for light machining only; max 90 Nm



Only the smallest amounts of lubrication are used in connection with MQL clamping tools—the application revolves around correct delivery of coolant to the cutting edge without any drop in pressure. The MQL compliant clamping tool plays a decisive role as part of the MQL delivery system.

Future-proof technology by acquiring the HORKUS license.

MQL stands out due to an enormously reduced consumption of lubricants in use compared to conventional wet machining.

There are two basic challenges for the clamping tool:

- a) Optimized leak-proofing for a leak-free aerosol stream with no fine mist of aerosol droplets, no build up of moisture in the clamping chuck.
- b) Lubrication delivery from the very first moment for a flawless aerosol flow without any drop in pressure to the cutting edge.

The new MQL generation from Bilz fully meets these requirements.

Optimized leak-proofing of our synchro chucks is unique on the market and is patented.

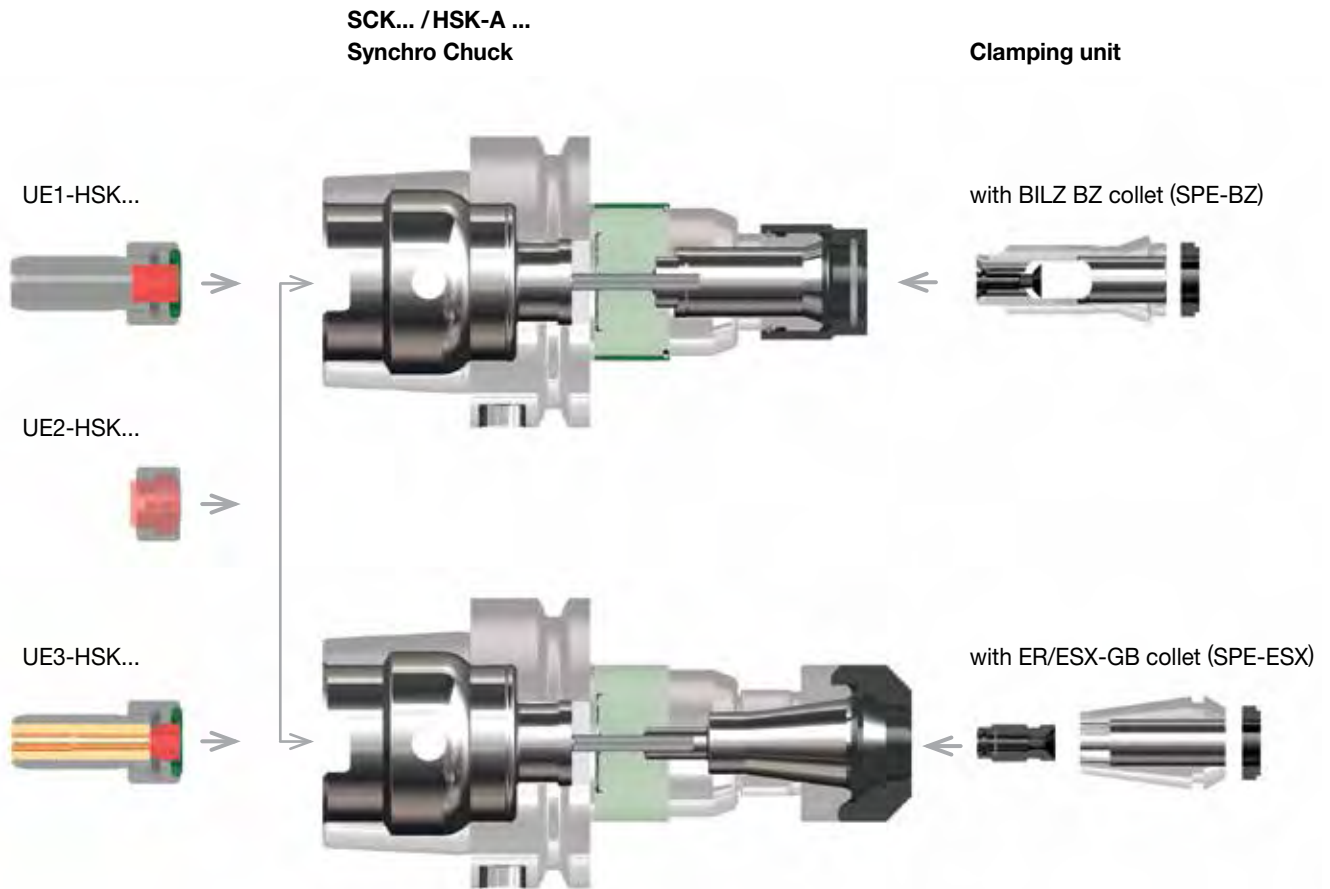

UE1 HSK Form A		UE2 HSK Form AC		UE3 HSK Form A	
automatic tool change IK and MQL 1 channel system		manual tool change IK and MQL 1 and 2 channel system		automatic tool change MQL 2 channel system	
Designation	SAP No.	Designation	SAP No.	Designation	SAP No.
UE1/HSK32	5040137	UE2/HSK32AC	5026724		
UE1/HSK40	5023928	UE2/HSK40AC	5023961	UE3/HSK40	5023934
UE1/HSK50	5023933	UE2/HSK50AC	5023060	UE3/HSK50	5023935
UE1/HSK63	5004090	UE2/HSK63AC	5021993	UE3/HSK63	5004093
UE1/HSK80	5003462	UE2/HSK80AC	5023939	UE3/HSK80	5023937
UE1/HSK100	5012117	UE2/HSK100AC	5023940	UE3/HSK100	5012068

ADVANCED SOLUTIONS

Tools designed to expand machining capabilities on CNC machining centers. Do more in a single setup with these “advanced application tools”.



VIEW
THE
WEBSITE



Bilz Floating Holders – Highest Quality for Perfect Finish and Accuracy

Highest possible drilling quality with perfect accuracy on reaming operations can only be achieved when the clamping system does not cause any radial force on the cutting tool. The requirement regarding the tolerance zone, the surface roughness and the roundness presupposes a clamping system which compensates all inaccuracy of position occurring. In addition, the system should be without circumferential backlash. Damage to the edges of the tool is thus avoided. This is guaranteed with Bilz floating holders.

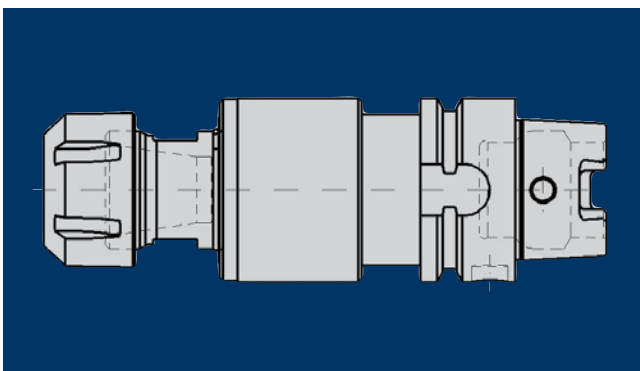



For the first time you can produce a high variety of inner and outer profiles with the highest possible precision by means of simple drilling and turning processes on normal machining centres.

formbore system tools can be used on:

- milling machines
- machining centres
- turning machines
- special machines

formbore system tools work independently of the machining spindle. It is not necessary to calculate and programme the synchronous coordination to the machine spindle. *formbore* system tools are designed for different profiles and profile sizes.

The *formbore* system tool can replace expensive processes such as reaming, erosion or milling. Further advantages are blind holes without residual chips and the constant accuracy due to the correction of the cutter wear. The torque support and the modular tool holders are identical to the ones used on the Bilz GNCK/GNCN tapping attachments.

Design and Mode of Operation of the *formbore* System Tools

formbore system tools consist of two components: cam drive and bore head. The rotating drive shaft is located in the case. The torque driven control determines the movement sequence of the bore head. The deflection of the boring bar is entirely controlled by rolling elements. *formbore* system tools therefore operate practically wear- and maintenance-free and make machining of most materials up to 900 N/mm² strength possible. For inside processing, a *formbore* is initially machined up to a maximum of 0.5 mm diameter smaller than the smallest ID of the shape. The actual form bore operation is carried out in a single process with profile adjusted speed and feed appropriate to the material being machined.

The *formbore* system tool is a system for a practical versatility, flexibility and time and cost saving in daily work. Let us know your processing requirements. You will receive our specific tool recommendation and our offer will convince you of the advantages of the *formbore* system tooling.

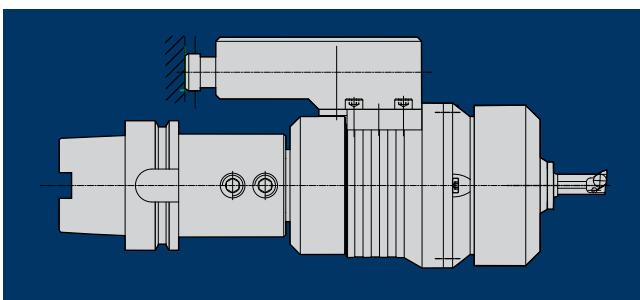

formbore System Tools for Machining Centers, Milling and Drilling Machines

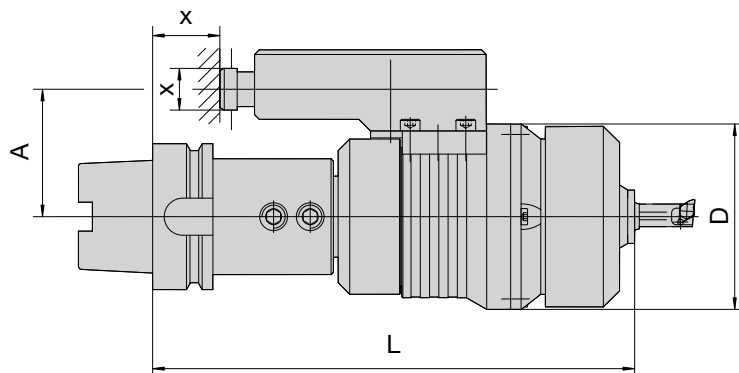

Description	A mm	n ^{max} rpm	Ø D mm	Profile (spanner size) mm	
FBT 1/...	≥ 51	1000	80	square: SQ4-14	hexagon: SQ4-21
FBT 2/...	≥ 51	500	125	square: SQ4-22	hexagon: SQ4-38

order example:

FBT 2 / 29 . 22

- 22 = Type MCH - 300
- 29 = Machine Manufacturer Heller
- 2 = formbore Size 2
- FBT = formbore Tool

formbore System Tools for Turning Machines

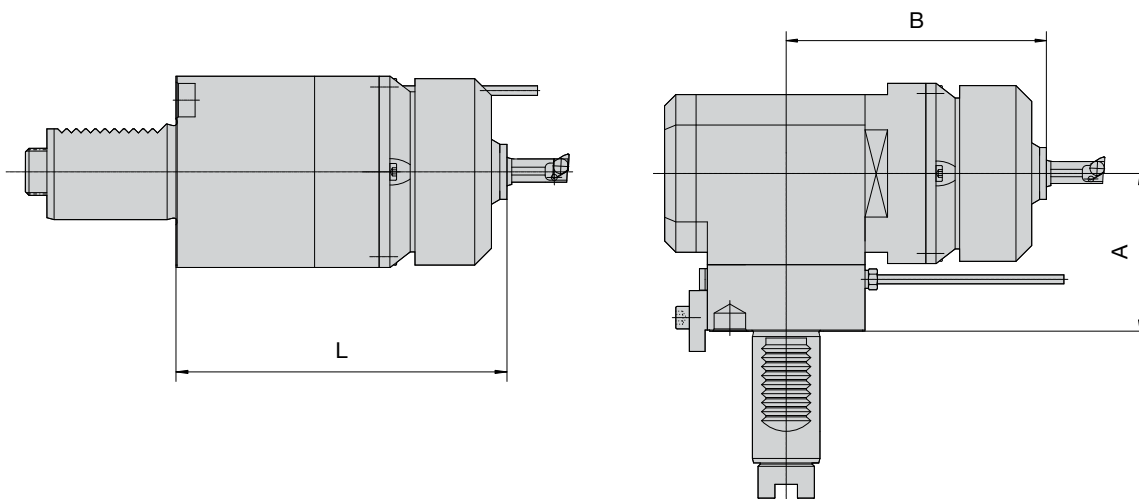

Description	n ^{max} rpm	Profile (spanner size) mm	
FBT 1/...	1000	square: SQ4-14	hexagon: SQ4-21
FBT 2/...	500	square: SQ4-22	hexagon: SQ4-38

order example:

FBT 2 / 100 . 1

- 1 = Type G200/V160
- 100 = Machine Manufacturer Index
- 2 = formbore Size 2
- FBT = formbore Tool

formbore Cam Blocks

The following profiles can be produced:

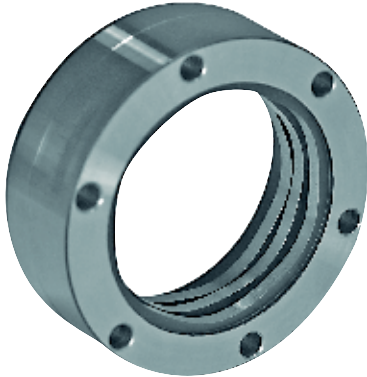

order example:

FBK 1 04 - 0810 / 1

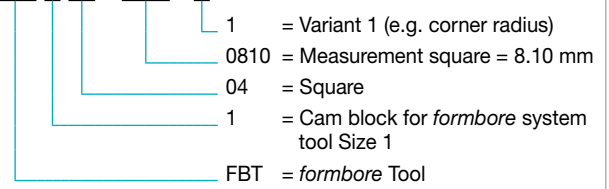

NOTE: Please include a drawing of the contour with all inquiries and orders in order to define the exact measurements of the cam block. The following formbore boring bars and formbore external turning bars are designed for the contour of the cam block.

Profiles	Square	Hexagon	Octagon	Area at the Cylinder	Spanner Size	Polygon as Pre-Processing
code	04	06	08	01	02	21

formbore Accessories for Internal Shapes

Bore out steel



Identification of the formbore boring bar

ASI 12 0700 / X

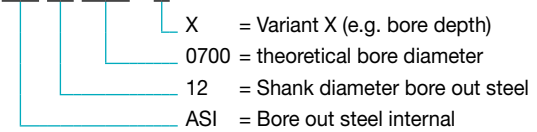

The bore out steels are coordinated with the geometry of the respective cam block

Insert Holder



Description

- ASI-26.00-07
- ASI-31.00-07
- ASI-38.00-07

Boring Bar

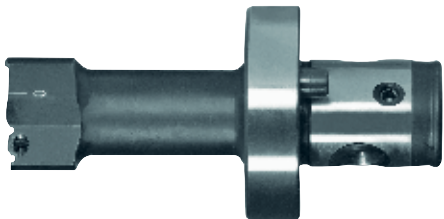

Description

- ASI-26/00-ABS40-44
- ASI-31/38-ABS40-44

formbore Accessories for External Shapes

Over turning steel:

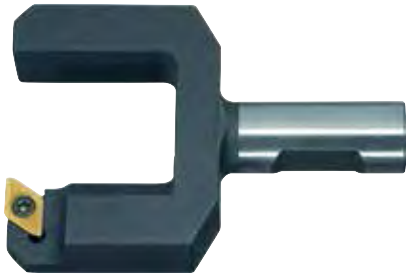

Identification of the *formbore* over turning steel

ASI 12 0700 / 1

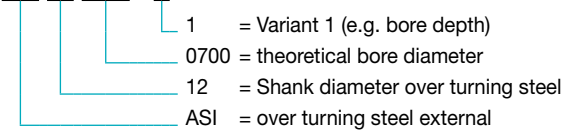

The bore out steels are coordinated with the geometry of the respective cam block.

Insert Holder



Description

ASI-26.00-07

ASI-31.00-07

ASI-38.00-07

Boring Bar

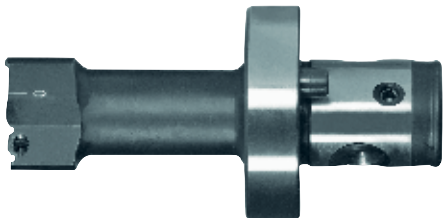

Description

ASI-26/00-ABS40-44

ASI-31/38-ABS40-44

Female Square SQ 12 mm



Material	Speed	Feed	Machine
Brass	550 rpm	0.04 mm/1	Turning Machine

Hexagon SQ 22 mm



Material	Speed	Feed	Machine
Brass	400 rpm	0.06 mm/1	Special Machine
Note: Interrupted Cut			

Keyway SQ 8 mm, depth 20 mm



Material	Speed	Feed	Machine
Steel 900 N/mm ²	550 rpm	0.03 mm/1	Turning Machine
Note: Interrupted Cut			



SFC Stud Driving Chucks

SFC for Gripping the Studs on the Thread

The Bilz SFC stud driver has been specifically designed for this tightening function. By using this tool, studs can be set quickly and safely to a required torque.

The process can be performed manually using pneumatic drivers, or automatically by means of a single or multi-spindle assembly machine.

The stud is located into the uniquely designed threaded jaws, in the closed position and is screwed into the jaws until it makes contact with the stop pin.

The stud is then driven into the tapped hole in the workpiece until it reaches its pre-set length or the required torque level. When the driver reaches either position, the threaded jaws are automatically opened, allowing the driver to be removed cleanly from the stud.

The driver can be removed from the stud, either with the spindle rotating or stationary.



ET1 Tool Holder Engraving Chucks

Special Tool to Identify Workpieces during the Manufacturing Process

Safety parts such as ABS brake parts for cars must be clearly identified due to product liability reasons. These parts are normally manufactured completely on machining centers and the marking will be done during the production.

The BILZ special tool holder ET1 can be changed like any other normal tool into the machine spindle. The ET1 has a spindle with ball bearings and an axial way of 10 mm with a specified force.

With suitable feed of the machine spindle the ball pen is pressed into the surface of the workpiece and through the machine program each required marking can be written.

The ball pen is clamped in a Rubber Flex® collet and easy to change.

All standard machine connections are available on request.



STF Tool Holder Stamping Chucks

Special Tool to Identify Workpieces during the Manufacturing Process

These toolholders are used for indicating workpieces on machining centers and special purpose machines in connection with stamping tools.

The toolholder with stamping tool is being automatically changed into the machine spindle. With the suitable feed or working hub the stamping tool is pressed into the surface of the workpiece.

For machine spindle safety reasons the tool holders have an axial force limitation up to max. 5000 N/1125 lbf. After activating the axial force there is 3 mm/0.1181 inch axial way available which should not be exceeded.

This automatic stamping process during manufacturing guarantees a faultless marking of the workpiece.

After the stamping process the tool holder snaps in automatically.

All standard machine connections are available on request.

TECHNICAL

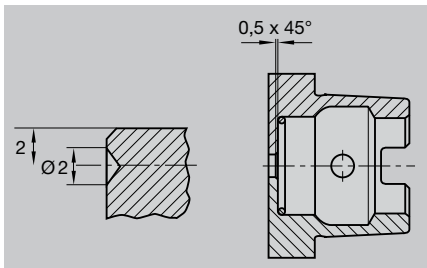
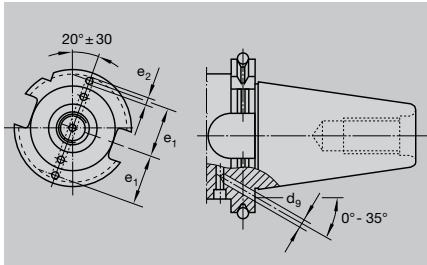
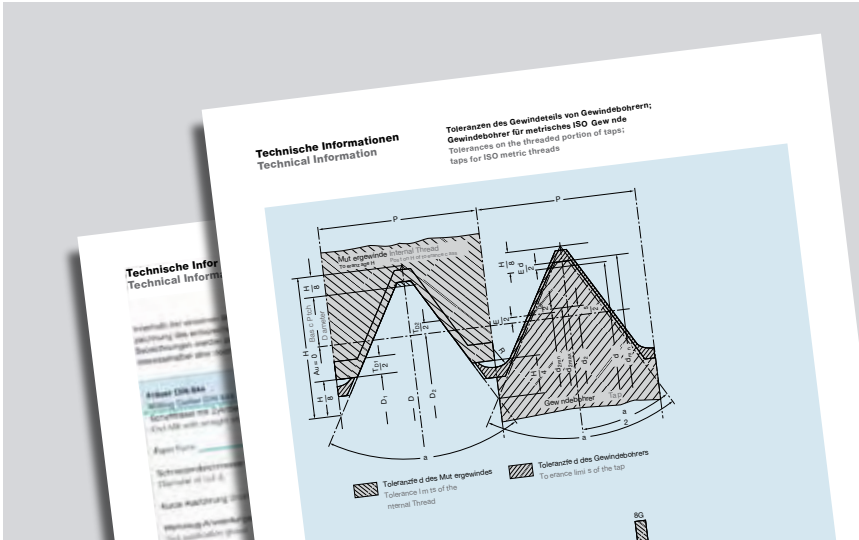

Torque setting in Nm	Metric	BSW Whitworth	BSP Whitworth Pipe	BSF Whitworth fine	BSP taper Whitworth Pipe tapered	BA	PG	NPT taper	UNC	UNF	Torque setting in ft/lbs
0.3	M2					No.9			No.2	No.2	0.2
0.4	M2.5					No.8				No.3	0.3
0.5	M3					No.7			No.3	No.4	0.4
0.6						No.6					0.4
0.8	M3.5	1/8"				No.5			No.4	No.5	0.6
1						No.4			No.5	No.6	0.7
1.2	M4	5/32"							No.6	No.8	0.9
1.6						No.3			No.8		1.2
2	M5					No.2				No.10	1.5
2.5				3/16"						No.12	1.8
3		3/16"				No.1			No.10	1/4"	2.2
4	M6	7/32"		7/32"		No.0			No.12		2.9
5		1/4"		1/4"						5/16"	3.6
6			G-1/8"	9/32"					1/4"	3/8"	4.3
8	M8			5/16"							5.8
10		5/16"							5/16"	7/16"	7.2
12				3/8"			PG-7			1/2"	8.7
16	M10	3/8"							3/8"		11
18			G-1/4"	7/16"	1/8"					9/16"	13
20							PG-9	1/8"		5/8"	14
22	M12	7/16"	G-3/8"				PG-11		7/16"		15
25				1/2"			PG-13.5				18
28							PG-16				20
32				9/16"					1/2"	3/4"	23
36	M14	1/2"									26
40	M16	9/16"		5/8"					9/16"		28
45				11/16"			PG-21			7/8"	32
50		5/8"	G-1/2"		1/4"				5/8"		36
56			G-5/8"					1/4"			40
63	M18				3/8"		PG-29				45
70	M20	3/4"	G-3/4"	3/4"				3/8"	3/4"	1"	50
80	M22		G-7/8"	13/16"			PG-36			1-1/8"	57
90				7/8"			PG-42			1-1/4"	65
100		7/8"					PG-48		7/8"	1-3/8"	72
110										1-1/2"	79
125	M24			1"							90
140	M27	1"	G-1"						1"		101
160			G-1-1/8"		1/2"			1/2"			115
180			G-1-1/4"	1-1/8"							130
200			G-1-3/8"	1-1/4"	3/4"			3/4"	1-1/8"		144
220	M30	1-1/8"	G-1-1/2"								159
240	M33	1-1/4"	G-1-3/4"						1-1/4"		173
260			G-2"	1-3/8"							188
280	M36										202
300			G-2-1/4"	1-1/2"							216
320	M39			1-5/8"					1-3/8"		231
340		1-3/8"	G-2-1/2"		1"			1"			245
360		1-1/2"	G-2-3/4"						1-1/2"		260
400			G-3"								289
420	M42		G-3-1/4"								303
450			G-3-1/2"	1-3/4"	1-1/4"			1-1/4"			325
480	M45		G-3-3/4"								347
500			G-4"	2"							361
560		1-5/8"			1-1/2"			1-1/2"			405
630	M48	1-3/4"							1-3/4"		455
710	M52			2-1/4"	2"			2"			513
800		1-7/8"		2-1/2"					2"		578
900	M56	2"		2-3/4"					2-1/4"		650
1000	M60				2-1/2"						723
1100	M64										795
1250	M68	2-1/4"							2-1/2"		904
1400		2-1/2"		3"	3"			2-1/2"	2-3/4"		1012
2000		2-3/4"						3"			1446
2200		3"									1591

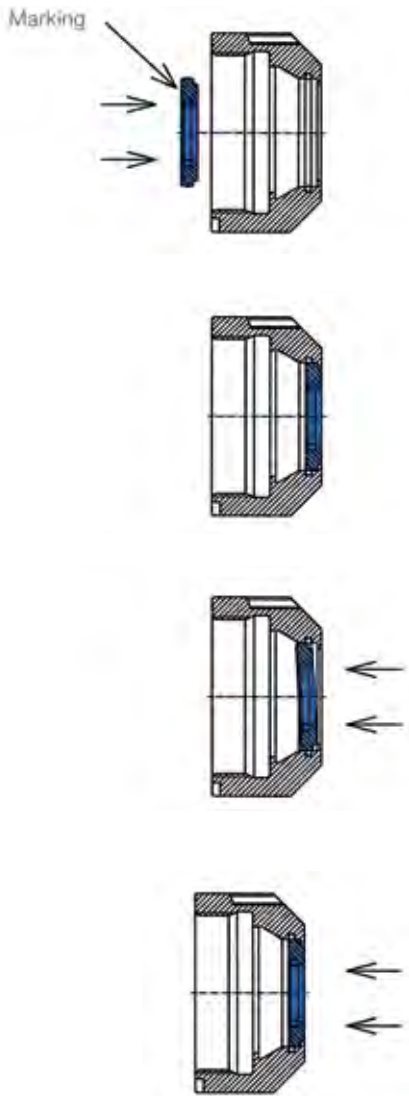

ASSEMBLING

Insert the small diameter of the disk into the center of the coolant nut and apply even pressure until the disk is properly seated into the nut.

The disk must be flush with the outside of the nut and the marking on the disk must be seen inside the nut.

REMOVING

To remove the disk, simply press on the outside of the disk evenly until it snaps out.



! Insert tool from the front. O-ring might be destroyed if cutting tool is inserted from the back.

! Take care when inserting the tool that you do not push back the sealing disc.

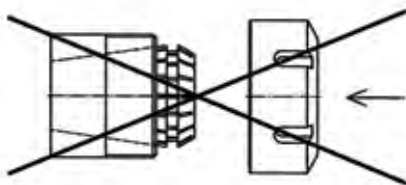
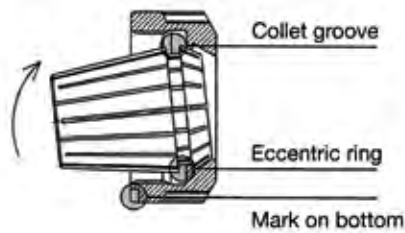

ASSEMBLING COLLET

Insert groove of the collet into eccentric ring of the clamping nut at the mark on the bottom of the nut. Push collet in the direction of the arrow until it clicks in. Insert tool. Screw nut with collet onto tool holder.

REMOVING COLLET

After the nut is unscrewed from the toolholder, press on the face of the collet while simultaneously pushing sideways on the back of the collet opposite the mark until it disengages from the clamping nut.

! Improper assembly can permanently damage the concentricity of the collet and may result in the destruction of the clamping nut. Only mount nuts with correctly inserted collets! Never place the collet into the holder without first assembling into the nut.

To avoid any damage of the synchro chuck use key **2** (SW) to hold the chuck while tightening the nut.

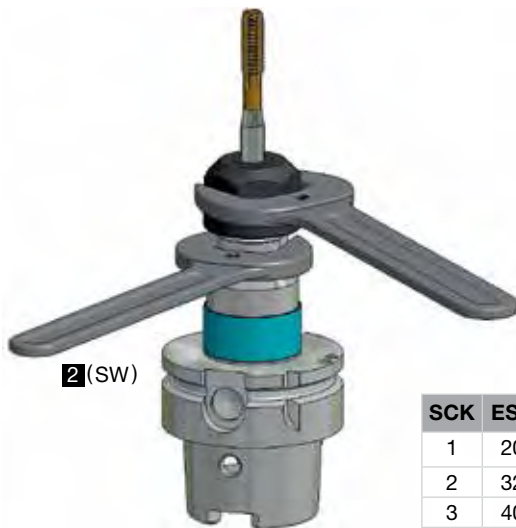

SCK	ESX	2 (SW)
1	20	23 mm
2	32	38 mm
3	40	46 mm

in combination with quick change tapping adaptors type WE... / WES...

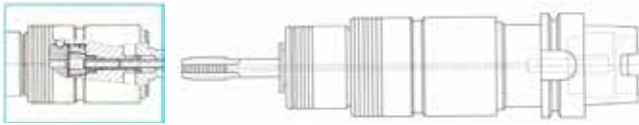

SCOPE AND AREAS OF APPLICATION

For tapping and forming in combination with quick change adaptors on turning, drilling-, milling machines as well as machining centres, multi spindle heads and special purpose machines.

Used horizontally or vertically and for left- or right-hand threads.

WFLC...-K/ versions with internal coolant supply and hydraulic pressure-neutral length compensation are suitable for coolant pressures up to 50bar.

We are pleased that you have decided on a BILZ product.

This manual describes the proper use and handling of the product.

Read the instructions carefully before use and use the product only in the manner specified by us.



IMPORTANT INFORMATION!

To prevent damage or injury, please follow the instructions exactly.

Tool change only with standing spindle!

Do not disassemble the products and do not make any modifications. This may result in damage and malfunction!

Use only tapping chucks and adaptors of BILZ company. The combination with other products may cause damage or malfunction!

The tapping chucks are maintenance-free, should there be any faults, please do not continue using the products. Please contact the Technical Service of the company BILZ.

Cleaning:

Periodically, we recommend to clean the chucks with a cleaning rag. This depends on the degree of contamination. Do not use any aggressive solvent.

No use of fibrous materials like e.g. cleaning wool.

Out of operation:

If the chuck is taken out of operation, note the following. Clean the chuck with a cleaning rag.

Spray or rub the chuck with a preservation oil, to prevent the formation of rust and preserve the smoothness of the chuck. Prior to storage, coolant and processing residues should be removed.

Use the product only for the recommended application of BILZ.

If you do have any questions please contact BILZ.

INSTALLATION INSTRUCTION

Keep clean the tool holder location in the machine spindle.

Hold the tool safe when changing tools, so when releasing the tool, the tool does not fall into the engine room and damaging the tool and / or work piece.

Note the tool dimensions and the machine manufacturer.

ATTENTION!

Hard start: The hard start in the chuck will cause an immediately cutting of the tap or forming tap. It is not adjustable!

Hard start: Engaged Disengaged

The WFLC-chucks are available in all common tool shanks, such as DIN69893-HSK, SKDIN69871, MAS-BT, ANSI-CAT, ABS, SK-DIN2080, TR-DIN6327, VDI-DIN69880v.

For customer-specific spindle designs, please contact the BILZ Technical Service.

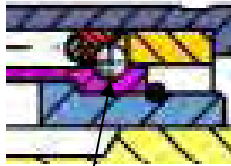

Engaged



Disengaged

OPERATING MANUAL

The quick change feature of the WFLC-chucks with out IC is operated by the length compensation. For changing the adaptors you have to compress it completely. (see arrow). At chucks with tension only you have to pull out the chuck on tension completely to insert the adaptors.

WFLC chucks with internal coolant supply do have a quick change mechanism independent from the length compensation to insert the adaptors. For the tool change you have to push back the black switching sleeve.

WFLC without IC switching sleeve

WES..-adaptors

WE. -adaptors

WFLC with internal coolant supply

The machine feed should be up to 5% smaller then the pitch of the tap to produce

threads in tolerance and good quality.

After spindle stop the over run may not be greater than the delay available pull compensation otherwise occur violence fractures of the tools. (this happens sometimes at older and/or bigger machines).

Quick change adaptors with safety clutch type WES.. you always have to combine with tapping chuck with length compensation on compression.

Reason: When the safety clutch starts working the length compensation on compression has to take up the rest of the axial movement of the machine to avoid tap breakage while using safety clutch adaptors.

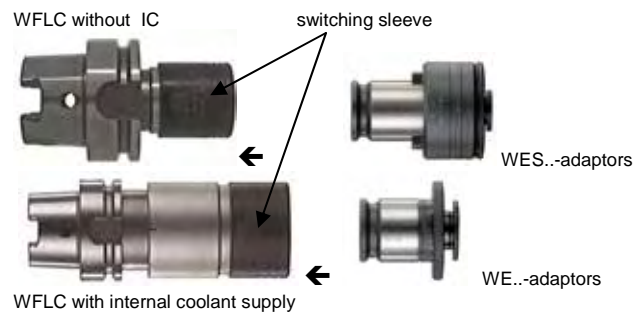

CHARACTERISTIC	END MILL HOLDER	DA COLLET CHUCKS	SC COLLET CHUCKS	ER COLLET CHUCKS
<p>T</p> <p>run out or error on rotation axis at the shank and cutting tool tip/edge</p>	<p>1</p> <p>Lowest precision due to bore tolerances, diametrical clearance and side lock screw forces.</p>	<p>Lower precision due to design and gripping accuracy.</p>	<p>Single angle design lends itself to high gripping strength and accuracy.</p>	<p>Highest single angle collet accuracy and solid carbide tool shank grip.</p>
<p>E A</p> <p>the capability of the tool shank diameters and styles</p>	<p>One size per tool limited to same size tool shank.</p>	<p>The DA (double angle) collet system has three collet size ranges accommodating shank sizes to 3/4" maximum diameter.</p>	<p>5</p> <p>SC (PG or TG) single angle collet systems have three series sizes accommodating tool shank sizes to a maximum of 1.500" diameter tool shank.</p>	<p>ER collet system is based on metric nominal sizes and has a tool angle different than the SC collet system. ER collets are available in six different sizes and can accommodate tool shanks to a maximum of 1.181" diameter shank.</p>
<p>A I</p> <p>rigidity of the holder under cutting tool loads and RPM changes.</p>	<p>Medium rigidity due to set screw clamping tool shank off center.</p>	<p>Median tool rigidity due to limit tool shank clamping force of DA collet design.</p>	<p>Best collet grip strength due to design. 3 to 1 torque value on tool shank.</p>	<p>3</p> <p>Good collet grip strength due to design. 2 to 1 torque value on tool shank.</p>
<p>A U</p> <p>simplicity of "assembly system" to be assembled and disassembled with the cutting tools.</p>	<p>1 or 2 set screws required to secure tool shank in tool holder.</p>	<p>May assemble tool, collet and collet nut in any sequence.</p>	<p>Requires collet to be inserted in collet nut before tool shank can be inserted into collet and then into tool holder body.</p>	<p>Requires collet to be inserted in collet nut before tool shank can be inserted into collet and then into tool holder body.</p>
<p>R I I</p> <p>"ring system" to maintain required optimal precision for the assembled system.</p>	<p>End mill holders require minimal maintenance other than ID bore integrity.</p>	<p>Regular cleaning of collet surface and collet body surfaces. Care of collets is most critical.</p>	<p>Regular cleaning of collet surface and collet body surfaces. Care of collets is most critical.</p>	<p>Regular cleaning of collet surface and collet body surfaces. Care of collets is most critical.</p>
<p>H B N</p> <p>stability based on ability to maintain tool balance at high RPM.</p>	<p>Designs are unstable at high RPM.</p>	<p>Lack of collet precision design and collet nut design makes DA system weak at high RPM.</p>	<p>Concentric collet and collet body design allow for moderate RPM use but collet nut design limits high RPM usage.</p>	<p>Concentric collet and collet body design allow for moderate RPM use but collet nut design limits high RPM usage.</p>
<p>O C T</p> <p>price of the tool clamp</p>	<p>Lowest cost tool holder system.</p>	<p>Lowest cost collet system due to lower precision system.</p>	<p>Median price tool holding system but must secure collet as well TG/PG collets price similar to ER collets.</p>	<p>Median price tool holding system but must secure collet as well TG/PG collets price similar to ER collets.</p>
<p>e h p u i</p> <p>performance of the assembled system.</p>	<p>While the most economical purchase, this tool style can be the most costly due to its low TIR and limited applications of tool sizes and RPM capabilities.</p>	<p>While this was the "original collet chuck system" it is limited in its accuracy and rigidity. It is great for narrow clearances and drilling applications.</p>	<p>This product was the 2nd generation of collet systems and is widely used today. Its gripping strength is the highest of SC or ER collet systems. One issue still remains and that is the shank engagement required for carbide shank tools.</p>	<p>The most flexible and accurate of the collet systems that are considered "industry standard" today. Good tool shank gripping strength and high accuracy with regards to TIR.</p>

COLLET CHUCKS	MILLING CHUCKS	HYDRAULICS CHUCKS	SHRINK FIT	CHARACTERISTIC
		5	5	PRECISION Toolholder precision is based on run out or TIR from centerline on rotation axis at the shank and cutting tool tip/edge
ighest single angle collet accuracy with close tolerance collet ID sizes for TIR improvement	Precision achieved is based on collet accuracy and torque value of assembled system	High TIR accuracy due to system design and manufacturing tolerances to rotational centerline	Highest TIR accuracy of all clamping systems.	
		1	1	VERSATILITY Expense of use is based on the capability to clamp multiple tool shank diameters and styles
me as ER collet system but with highest TIR accuracy through a controlled manufacturing process.	Reduction collet system designed to operate in conjunction with the roller bearing clamping system design in the collet nut	Single size ID per tool clamping system. Accommodates a single shank size	Single size ID that accommodates a single size tool shank requiring H6 or H7 shank tolerance	
		4	5	TOOL CLAMPING RIGIDITY w rigid is the cutting tool shank secured in the body of the holder under cutting tool loads and RPM changes.
od collet grip strength due to design. 2 to 1 torque value on tool shank. Collet collapse restriction limits rigidity	Strongest gripping collet system. Gripping strength is nearest thermal clamping strength	Good clamping rigidity for “Z” axis use only. Radial loads can damage internal hydraulic sleeve design.		
		2	4	EASE OF USE Ease of use is based on the simplicity of the “clamping system” to be assembled and disassembled with the cutting tools.
quires collet to be inserted in collet nut before tool shank can be inserted into collet and then into tool holder body. HP ER collets have limited collet collapse range.	Reduction collet system.	Tool insertion is completed and then pressure clamp screw is adjusted to increase “hydraulic” clamp forces surrounding the sleeve holding the tool shank.	Requires shrink fit machine to heat the tool clamping bore allowing tool shank insertion.	
		4	5	RELIABILITY How reliable is the “clamping system” to maintain the required optimal precision for the assembled system.
egular cleaning of collet surface and collet body surfaces. Care of collets is most critical.	Regular cleaning of collet surface and collet body surfaces. Care of collets is most critical.	Regular cleaning of bore required. Only solid and cylindrical shanks with no voids can be used in this system.	No mechanical parts to wear out or be maintained.	
		4	5	HIGH RPM/ TOOL BALANCE machining RPM increase, tool balance is important. Value based on ability to maintain tool balance at high RPM.
ncentric collet and collet body design allow for moderate RPM use but collet nut design limits high RPM usage.	Concentric collet and collet body design allow for moderate RPM use but collet nut design limits high RPM usage.	Body design and “fluid clamping” system limits high RPM usage.	No mechanical parts and designed for balance stability at high RPM.	
		5	3	ECONOMY/COST Cost or purchased value of the tool clamping system.
edian price tool holding system but must secure collet. HP (PG/TG HP or ER HP) are higher cost than standard collets.	Higher cost of holder due to design and clamping system.	Most expensive tool clamping system.	Median price of tool holder but shrink fit machine needs to be purchased to support the system.	
		3	5	VALUE Value of the productivity and tool performance gained from the assembled system.
ame as the ER collet system but with higher TIR accuracy. Much more costly collets than standard ER style collets.	Great tool shank gripping strength and excellent TIR accuracy. Excellent value for large shank tools and high radial tool loads when using heavy feed rates. Large nose limits clearances in pockets.	Highest accuracy for “Z” axis drilling. Expensive tool that usually needs replacement every 3- 5 years. Limited uses for end milling as radial lows must be light to reduce risk of damaging holder bore.	After investment is made, this system offers all the productivity benefits for milling, drilling, and reaming. Most rigid, highest TIR accuracy, and best tool gripping strength of all clamping systems. Best overall value when considering tooling cost with productivity and part accuracy achievements.	

"EVERY DAY, THE WORLD SHRINKS A LITTLE MORE."



BILZ

We'll Take You Where You Need to Go.

All of our products are "best in class" technologies that help our customers remain competitive and profitable. We have something that can help you too! Learn more at www.bilzusa.com.

The Latest Technology. The Best Quality. Extensive Product Support.

We hold our promise in three important ways: First, by delivering the most advanced tool clamping technology available; Second, by maintaining the highest level of quality; Third, by providing the strongest product, application and engineering support in the industry. **Let us prove it! Bilz Tool Company, Inc.**

www.bilzusa.com | 1140 N. Main Street | Lombard, IL 60148 | 847-734-9390