



NEW!
INTERACTIVE PDF

Click on the underlined text

BRINGING THE BEST OF THE WORLD TO YOU[®]

SAFETY PRODUCTS CATALOG

PROTECTIVE INDUSTRIAL PRODUCTS, INC.
www.pipusa.com

HAND PROTECTION

- 11** Cut Resistant Gloves
- 55** General Purpose Gloves
- 83** Chemical Resistant Gloves
- 95** Disposable Gloves
- 101** Critical Environment Gloves
- 109** High Performance Gloves
- 119** Cold Protection Gloves
- 123** Heat Protection Gloves
- 127** Emergency Responder Gloves
- 129** Parade & Uniform Gloves

ARM PROTECTION

- 132** Smart-Fit™ Technology Sleeves
- 134** Form-Fit Seamless Knit Sleeves
- 142** Loose Fitting Sleeves
- 141** Duo-Pro™ T-shirt with Integrated Sleeve
- 144** Specialty Applications Sleeves
- 146** Custom Sleeves

HEAD PROTECTION

- 150** Type II Hard Hats
- 151** Type I Hard Hats
- 157** Hard Hat Accessories
- 160** Bump Caps
- 162** Gear Bags & Rescue Helmets
- 163** Fire Helmets
- 164** Winter Liners
- 166** Flame & Fire Resistant Hoods

HEARING PROTECTION

- 168** Ear Muffs
- 170** Ear Plugs
- 172** Additional Styles & Accessories

EYE & FACE PROTECTION

- 174** Lens Technologies
- 178** Safety Glasses
- 208** Safety Goggles
- 212** Face Protection
- 214** Eyewear Accessories

HI-VIS APPAREL

- 216** ANSI Standards
- 218** Hi-Vis Vests
- 228** Hi-Vis T-Shirts
- 229** Duo-Pro™ T-shirt with Integrated Sleeve
- 230** Hi-Vis Sweatshirts
- 232** Hi-Vis Jackets & Coats
- 234** Hi-Vis Overpants

RAINWEAR & SPLASHWEAR

- 236** Hi-Performance Protective Clothing
- 239** Hi-Vis Rainwear
- 240** Protective Rainwear

APRONS & DISPOSABLE CLOTHING

- 241** Custom Aprons
- 242** Disposable Clothing

FLAME RESISTANT & ARC RATED CLOTHING

- 244** AR/FR Sweatshirts
- 245** AR/FR Shirts
- 246** AR/FR Hi-Vis Vests
- 247** AR/FR Additional Clothing
- 248** Dual Certified Clothing
- 250** Arc Flash Protection Kits
- 254** Arc Flash Head Gear
- 256** Arc Flash Accessories

RUBBER INSULATING GLOVES

- 258** Rubber Insulating Gloves & Sleeves
- 260** Leather Protectors
- 260** Accessories

ERGONOMICS

- 262** Wrist & Elbow Supports
- 263** Knee Pads & Supports
- 264** Back Supports

RESPIRATORY & FIRST AID

- 266** N95 Respirators
- 267** Disposable Nuisance & Face Mask
- 268** Personal & Contractor Kits
- 269** Bloodborne Pathogens Kits
- 270** Burn Kit

SAFETY & EMERGENCY BEACONS

- 272** F-Flare™ Beacons
- 274** Flash Batons

HEAT STRESS

- 276** Phase Change
- 276** Evaporative
- 280** Absorptive
- 280** Sun Protection

Protective Industrial Products is a proud member of



AFFILIATED DISTRIBUTORS
The Largest Distributor Network in North America.



EVERGREEN MARKETING GROUP
An alliance of over 60 independent construction and industrial tool distribution companies located throughout the United States.



INDUSTRIAL BUYER'S CONSORTIUM
Alliance of Leading Industrial Supply Distributors in the U.S.



INDUSTRIAL SUPPLY ASSOCIATION
Formerly the Industrial Distributor Association (IDA) and the Industrial Supply Manufacturer Association (ISMA).



NETPLUS ALLIANCE
Alliance for Distributors and Manufacturers.



SAFETY MARKETING GROUP
The World's Largest Consortium of Independently Owned Safety Equipment Distributors.



SPHERE 1
A cooperative of independent tool and fastener distributors working together to achieve competitive and sustainable advantages in the marketplace.



STAFDA
STAFDA is an international educational association comprised of distributors, manufacturers, rep agents, and affiliates (trade press) serving the construction/ industrial market.

PROTECTIVE INDUSTRIAL PRODUCTS

BRINGING THE BEST OF THE WORLD TO YOU®



PROTECTIVE INDUSTRIAL PRODUCTS OR PIP, AS WE HAVE BECOME KNOWN, IS A US-BASED COMPANY WITH OPERATIONS AROUND THE WORLD.

PIP is jointly owned by the families of Joe Milot, President, and his partner, Wellson Tao. Initially started as a supplier of work gloves, today we are a global provider of a vast array of consumable personal protective equipment (PPE) to multiple industries and channels of distribution.

PIP STARTED AS A SUPPLIER OF GLOVES. TODAY WE ARE A GLOBAL PROVIDER OF A VAST ARRAY OF CONSUMABLE PERSONAL PROTECTIVE EQUIPMENT TO MULTIPLE INDUSTRIES AND CHANNELS OF DISTRIBUTION.



WE FIND REASONS TO SAY "YES" TO CUSTOMERS

WE PLACE THE CUSTOMER EXPERIENCE ABOVE ALL ELSE. WE SUCCEED AT HELPING DISTRIBUTORS ENHANCE THEIR PRODUCT OFFERING, WHILE MAINTAINING THE ABILITY TO PROVIDE CUSTOMERS WITH COMPETITIVELY PRICED, QUALITY SAFETY PRODUCTS.



AN EASE OF DOING BUSINESS

We strive to be the easiest company that our customers do business with in any industry.



OUR PEOPLE

We employ people trained and experienced in the business and recognized among the best in the industry.

A GLOBAL PROVIDER OF INNOVATIVE SAFETY PRODUCTS

As the referenced leader in hand protection, we continue to expand our above-the-neck, electrical, traffic safety and first responder product lines.

- Three manufacturing facilities along with three distribution centers in the US
- Export operation from Asia/Pacific to over 10 sales and distribution subsidiaries around the world
- Expertise in sourced manufacturing driven by a team of technical product managers and on-site quality inspection personnel
- R&D capabilities include specialty yarns and seamless knitting technology, joint development in new lens/fit applications in eyewear, as well as ergonomic garment design
- Collaborative development with global partner ATG® for hand protection, JSP® for head and respiratory protection, Hellberg® for hearing protection and Pacific Helmets for first responder head protection

BRINGING THE BEST OF THE WORLD TO YOU®

1984 to 1999



1984

- Joe Milot and Wellson Tao formed Protective Industrial Products in a 400 sq. ft. space in Albany, NY.

1991

- Purchased assets of Intermarket Imports, Inc. and expanded head office and distribution center into a 28,000 sq. ft. facility in Guilderland, NY.



1998

- Acquired L.A. Sinotech & established a distribution center in California

2000 to 2005

2001

- Acquired Georgia Safety Group and Gloves Unlimited, Inc.
- Opened a distribution center in Memphis, TN.

2002

- PIP Mexico formed



2003

- Acquired PRI Industries - a US manufacturer of specialty seamless knits



2004

- Expanded New York operations to 125,000 sq. ft. and Tennessee distribution center to 90,000 sq. ft.
- Established exclusive sales partnership with ATG® Gloves in North America
- PIP Latin America formed

2006 to 2010

2006

- Brahma Glove Co. acquired - consumer division established
- Mud® consumer glove brand and business acquired
- DSM Dyneema® license acquired



2008

- West County Gardener® consumer glove brand and business acquired
- PIP Italy established in Rome



2009

- SafetyGear™ USA acquired to extend safety products offering to protective and hi-vis garments

2011 to 2016



2011

- H.L. Bouton® Eyewear brand and business acquired
- Established exclusive sales partnership with JSP® in North America
- McHenry Knitting and Manufacturing acquired
- Certified Insulating Products assets acquired to enter the electrical safety market
- DuPont™ Kevlar® license acquired
- PIP Balkans formed
- PIP Iberia formed

2012

- ISSI Eyewear acquired
- PIP Canada established
- PIP Asia/Pacific operations expanded from Hong Kong to include sales and distribution centers in Malaysia and China

2014

- Acquisition of Safe Industries - manufacturer of knitted sleeves

2016

- Acquisition of Safety Works



PIP TODAY

Over 300 employees

Global presence in the Americas, Europe and Asia/Pacific

Referenced global leader in hand protection

Over 3,500 products available from distribution centers totaling 500,000 sq. ft. in the US alone



PIP VENDING READY PROGRAM

BRINGING THE BEST OF THE WORLD TO YOU®

PIP VEND READY PACKAGED FOR VEND MACHINE



VEND-READY GLOVES: STOCKED & READY TO SHIP

Over twenty of our most popular glove styles are now available in vend-ready packaging. These are stocked and ready to go. Consistent width and thickness ensures proper dispensing.

MANY OF PIP'S PRODUCTS ARE VEND-READY IN THEIR STANDARD PACKAGING

HI-VIS VESTS AND T-SHIRTS

All PIP Hi-Vis Vests and T-shirts are or soon will be in vend-ready packaging! See page 218 for our complete product selection.

BOUTON® OPTICAL

All PIP safety glasses and safety goggles are vend-ready! See page 178 for our complete product selection.



WE CAN VEND-READY ALMOST ANYTHING. Our Black Pearl manufacturing facility specializes in custom logoing, packaging and testing. We can do any configuration to meet your special needs.

CUSTOMIZED RETAIL READY™ PROGRAM

PIP IS YOUR SAFETY PRODUCT PARTNER FOR MAXIMIZING YOUR SHOWROOM PRODUCT SALES.

No two showrooms are the same, constricted sometimes by space and other times by location, it is our job to adapt to your needs. That's what PIP's customized Retail Ready™ Program is all about.

Over 30 years of industrial and do-it-yourself retail market experience has allowed us to develop an extensive line of PPE products individually packaged and ready to retail, out the door.

PIP RETAIL READY TAILORED TO YOU.

**PIP
RETAIL
READY**

PIP RETAIL READY PROGRAM

BRINGING THE BEST OF THE WORLD TO YOU®



SHELF TALKER



BASKET TALKER



PEG TALKER

PIP RETAIL READY DISPLAY TALKERS

Laminated and durable, these display talkers come complete with mounting ties and mention features that resonate with customers. Clear bullet points identify the product, key features and ideal use. That's all that's needed to make the difference.

FOR YOU. BY YOU.



THINK LIKE A RETAILER

To do Retail Ready right, you have to think like a retailer. It's all about taking advantage of seasonality and trends. PIP already offers you the most comprehensive early-buy program in the industry. We now include separate early-buy special point-of-sale deals that are tailored to take maximum advantage of your walk-in traffic. Take for example the first storm of winter; think of how many customers forget their gloves. Maximize sales with a winter glove rack sitting on your counter ready to pump those impulse sales.

EYE-CATCHING POINT-OF-PURCHASE DISPLAYS ARE THE KEY

Standard available displays are meant to be versatile and adaptable in all showrooms.



GONDOLA DISPLAY



DUMP DISPLAY



TOWER DISPLAY

CUSTOMIZED PLANOGRAMS JUST FOR YOU

PIP can tailor your slat wall or gondola display unit to hold key products. With over 30 years of experience and core expertise in our PIP consumer products division, we're sure to help you in putting together a fast-turning product configuration that meets your needs.

Working with your PIP representative, we can provide you with top sellers in each market channel and our recommendations for optimizing your point-of-purchase displays.





PIP CUSTOM IMPRINTING

BRINGING THE BEST OF THE WORLD TO YOU®

CUSTOM IMPRINTING IS AVAILABLE ON MOST SAFETY EYEWEAR, HARD HATS, GLOVES, VESTS, T-SHIRTS, SWEATSHIRTS, JACKETS, COOLING TOWELS AND BANDANAS.

We use the most advanced technique and quality ink that ensure your logo pops and will not wear off. It's not just our image – it's yours too.

CUSTOM IMPRINTING

FAST. DEPENDABLE. QUALITY PRINTING.

PIP CUSTOM IMPRINTING

BRINGING THE BEST OF THE WORLD TO YOU®

6-DAY TURNAROUND TIME



STATE-OF-THE-ART FACTORY

- 6-day turnaround*
- Low minimums
- Over 12 standard PMS colors available
- Ordering software backed by a specialized core team

**Following approval of logo artwork*



OVER 40% OF COMMON PPE IS LOGOED

- Builds brand presence
- Promotes security on job sites
- Reduces waste

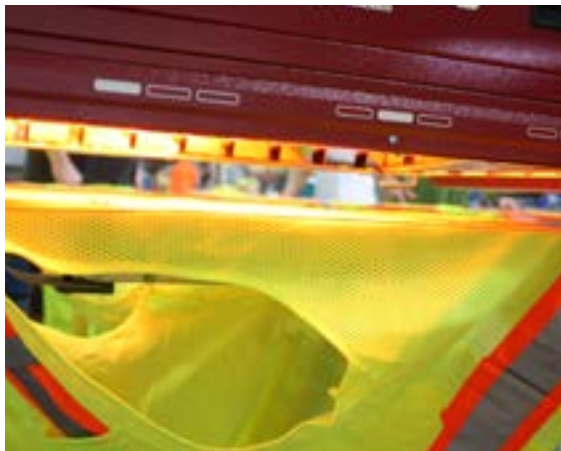
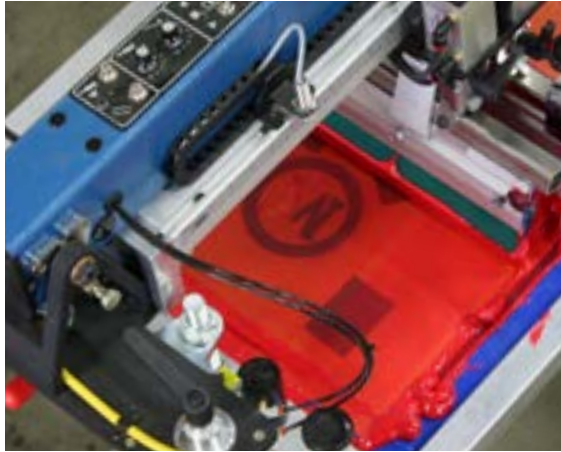

EXPERIENCE THE DIFFERENCE

FAST, EASY AND PRECISE. If you don't associate these words with your custom order requests, you're not taking advantage of PIP's logo and imprinting services. With exceptionally quick turnaround times and top quality results, PIP delivers the value-added service you and your customers expect. Put us to the test on your next logo order and experience the difference.

PIP SALES & MARKETING LEADERS

BRINGING THE BEST OF THE WORLD TO YOU®



Forward-Thinking Customer Service

- PIP's Customer Service team has a mission that is beyond J-I-T delivery and world class service; it extends to cover accuracy in information and flawless data transfer and elimination of redundancy.
- EDI order placement, confirmation and payment
- Accuracy plus updated pricing, inventory and product revisions
- Dedicated technical support



Best Trained Sales Team in the Industry

Training is our mission. Customers don't feel confident selling or using product if they're not trained. Lack of confidence leads to mistakes. PIP is dedicated to training all customers.

- Over 100 representatives on the road
- Backed by 30 Regional Sales Managers and National Account Representatives
- SR management team with a combined 120 years of experience in Safety

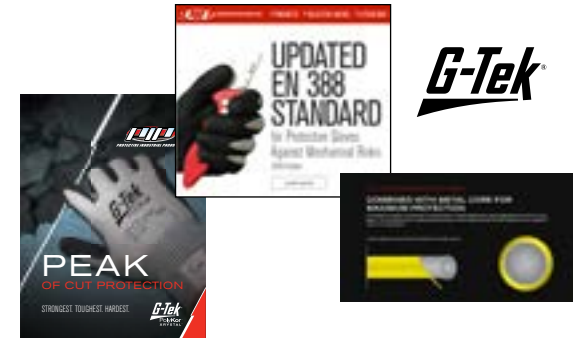

Marketing – Sales Tools and Promotions to Give You the Edge

- Powerful brands
- Communication
- Digital and print collateral
- Complete product launches
- Advertising and promotions
- Enhanced brand packaging
- Expert pages & videos



Manufacturing Capability

PIP owns three US-based manufacturing operations:

1. **PR Industries (PRI)**, in Chaska, Minnesota produces high-quality specialty knitted gloves for applications requiring cut resistance and resistance to heat. PRI is capable of designing and producing coating patterns that meet specifications on string-knit shells to fit with customers' needs.
2. **McHenry Manufacturing's** knitting and sewing operation in Bluffton, Indiana specializes in protective sleeves, work aprons and hoods.
3. **Black Pearl** Guilderland Center, New York facility offers custom packaging, imprinting and labeling as well as dielectric testing for electrical insulating gloves and is a manufacturer of specialty insulated electrical tools.



Product Selector Guides



WE MAKE IT EASY FOR YOU

Our product selector guides will give you the proper answer in just a few clicks and seconds.



CHEMICAL RESISTANT GLOVES SELECTOR GUIDE

Type in your CAS# or select the chemical from our chemical list and we will show you all of our gloves that have been tested against that chemical.



CUT PROTECTION GLOVES SELECTOR GUIDE

Answer four quick questions and we'll give you the product that gets the job done.

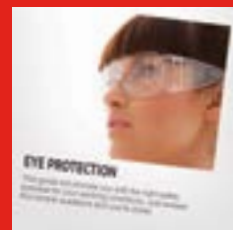

EYE PROTECTION SELECTOR GUIDE

This guide will provide you with the right safety eyewear for your working conditions. Just answer four simple questions and you're done!

Other Exciting Website Features

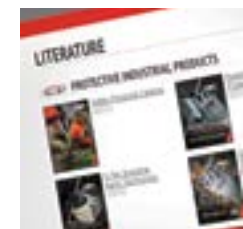

DOWNLOAD SPEC SHEETS & LITERATURE

All the valuable information you need at your fingertips. Helping you lose those stacks of papers with easy to download spec sheets and literature.



VIDEO FEATURETTES

Informative, short videos that pack a lot of punch and are loaded with product features and benefits.



ICONS THAT ARE INFORMATIVE

What does that icon or rating mean? Scroll over our enhanced icons to learn more about our products' capabilities.



WORLDWIDE LOCATIONS

Conducting international business? We provide country – and language-specific websites for over 10 countries.



TOUCH SCREEN FRIENDLY

Access our website on the go from your smart phone or tablet without losing any of the website's capabilities.

GO TO WEBSITE

4 EASY WAYS TO FIND THE PERFECT PRODUCT

- 1 SEARCH THE PRODUCT SELECTOR GUIDE
- 2 BROWSE BY PRODUCT CATEGORY
- 3 BROWSE BY INDUSTRY CHANNEL
- 4 SEARCH BY SKU NUMBER

PIP 3SP™ PROGRAM

BRINGING THE BEST OF THE WORLD TO YOU®



SIMPLE SAFETY SOLUTIONS

ON SITE

ASSESSMENT SURVEY

Working collaboratively with our distributor-partners, we perform all 3SP™ site surveys. This assures industrial customers that they are done effectively and without any downtime. 3SP™ trained representatives have a broad understanding of complex manufacturing environments and processes. Chances are they've met many similar challenges before with proven solutions.

TRAINING SEMINARS

The PIP 3SP™ team consists of Product Specialists, Product Managers and PIP Sales Partners, who most often are providers of finished and raw-material products. Qualified and ready to train at your facility, or at our PIP headquarters in Latham, NY or our facility in Memphis, TN where you can experience our customer training center, complete with hands-on activities.

TOOLS TO

MAKE THE JOB SAFER

Today's work environment is dynamic. Aging workforce, transient and diverse workers, and increased reliance on automation create challenges related to communication, distraction, stress, and fatigue – all operating at a higher intensity. Training and orientation is short, and we rely on quick and comprehensive tools for answers.



3SP™ IS A MULTIFACETED, LEARNING-BASED PROGRAM DESIGNED AND TAILORED TO MEET THE NEEDS OF OUR CUSTOMERS.



We advance-schedule up to ten 3SP™ training seminars per year at our customer training center in Latham, NY. Call us at (800) 262-5755 to inquire about dates.

BRINGING THE BEST OF THE WORLD TO YOU®

- 11 CUT RESISTANT GLOVES
- 55 GENERAL PURPOSE GLOVES
- 83 CHEMICAL RESISTANT GLOVES
- 95 DISPOSABLE GLOVES
- 101 CRITICAL ENVIRONMENT GLOVES
- 109 HIGH PERFORMANCE GLOVES
- 119 COLD PROTECTION GLOVES
- 123 HEAT PROTECTION GLOVES
- 127 EMERGENCY RESPONDER GLOVES
- 129 PARADE & UNIFORM GLOVES

HAND PROTECTION



ADVANCED

CUT RESISTANT FIBER AND YARN



G-Tek[®]
PolyKor[®]
XRYSTAL[™]

Represents the latest iteration of PolyKor[®] in which it is combined with naturally hardened crystallized minerals. The result is a super tough, durable, cut resistant fiber that is at the peak of performance.



G-Tek[®]
PolyKor[®]

PolyKor[®] Engineered Yarns optimize performance, function, and protection using proprietary blends of select fibers to exceed industry standards. The ultimate objective is affordable cut resistant gloves for practically every application.

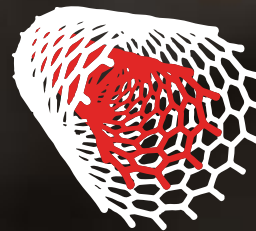

G-Tek[®]
Suprene[™]

The latest breakthrough in nanofabrication has resulted in Suprene[™] – an affordable fiber with unparalleled strength and physical properties.

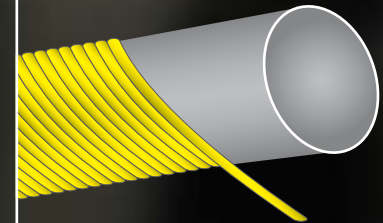

G-Tek[®]
KEV[™]

Takes the power of DuPont[™] Kevlar[®] and combines it with proprietary core technology for maximum cut strength and protection in light heat applications.

CUT PROTECTION MATERIAL BASICS

| NAME | ADVANTAGES | DISADVANTAGES |
|---|---|--|
| HIGH-PERFORMANCE POLYETHYLENE HPPE | - High strength, high cut and abrasion resistance - Cool and comfortable | - Low heat tolerance |
| KEVLAR® Aramid fiber | - Good mechanical and cut resistance - Lightweight - Inherent heat properties | - Low resistance to UV rays and moisture |
| GRAPHENE | - Tough, strong and highly cut resistant | - High thermal conductivity |
| STAINLESS STEEL Metal yarn | - Excellent cut resistance | - Heavyweight - Poor flexibility - Heat and electricity conductor |
| GLASS FIBER Textile-grade glass fibers (silica) | - Strong, high initial cut resistance | - Poor wear performance as a result of fiber breakage causing reduced protection and possible skin irritation. |

GENERAL PURPOSE MATERIAL BASICS

| NAME | ADVANTAGES | DISADVANTAGES |
|---|--|---|
| NYLON Synthetic fiber | - High resistance to abrasion and fatigue - Higher durability and strength | - Low resistance to heat |
| POLYESTER Synthetic fiber | - Good resistance to abrasion - Chemical resistance | - Low resistance to heat |
| COTTON Natural fiber | - Low price - Comfortable | - Low mechanical resistance |
| ELASTANE FIBER SPANDEX® / LYCRA® Additive fiber | - High degree of elasticity and comfort - Resistant to abrasion | - Loses elastic properties with heat and wear |
| NATURAL LEATHER Tanned animal pelt | - Good resistance to tension, puncture and abrasion - Flexible, soft & breathable | - Cuts easily – no cut protection - Inconsistent quality |

TECHNOLOGIES

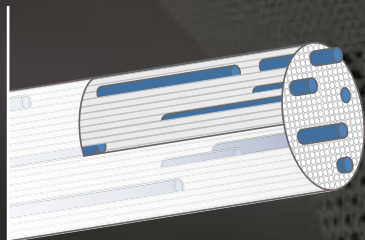

G-Tek®
3GX®

Embedded micro-particles strengthen fibers by up to two times, for higher cut scores. 3GX® offers cool touch comfort and lightweight for improved productivity.

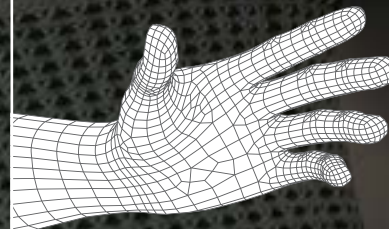

MaxiFlex®
CUT™

Maxiflex® Cut™ gloves synergize proprietary yarns with advanced glove design - applying coatings, technologies, and processes that are above-and-beyond when compared to conventional coatings and manufacturing processes. The result is the ultimate in comfort and durability.



A COMPLETE LINE OF COATINGS LIKE NEVER SEEN BEFORE

Coating grip is key in preventing razor sharp objects from slipping and making contact with hands or arms. Polymer coatings offer some degree of extra protection, however, they will slice easily with razor sharp blades and cannot be relied upon for boosting cut protection. Thicker, tougher materials such as latex and nitrile offer added protection when handling heavier objects with rough edges or burrs.

GET A GRIP



TOUCH SCREEN COMPATIBILITY

Resistive touchscreens, such as those found on most industrial controls, rely on resistive pressure and are unaffected by the use of gloves.

Capacitive touchscreens typically used in tablets, smartphones and laptops rely on the electrical field effect from our finger. PIP trials have found that our disposable gloves and many of our coated seamless knit gloves with thinner coatings will work with today's latest mobile devices. However, we recommend trials prior to equipping teams with gloves. For guaranteed bare-finger precision and sensitivity on any device, we provide the PU coated G-Tek® [33-GT125](#), featuring conductive fingertip touch technology.

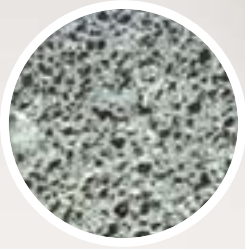

MICROSURFACE

2 LAYERS

- Flexible and tough
- No breathability

1 LAYER

- Thin with maximum dexterity
- Slight breathability



MICRO-FOAM

1 LAYER

- Thin and tough-wearing
- Maximum 360° breathability

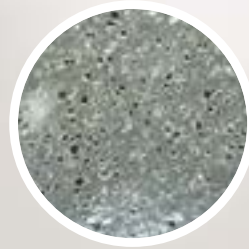

FOAM

1 LAYER

- Flexible and tough
- Fair breathability

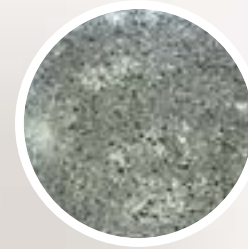

NEOFOAM™

1 LAYER

- Highly flexible and tough
- Good breathability

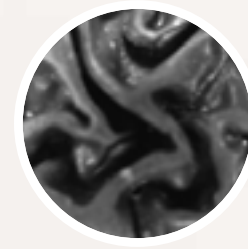

CRINKLE

1 LAYER

- Flexible and tough
- No breathability



FLAT/SMOOTH

1 LAYER

- Thin, high tactility
- Fair breathability

| COATING | COATING MATERIAL | DRY GRIP | | | | | SUCTION ACTION ON WET/OILY | BREATHABILITY | | | | DURABILITY | | | LIQUID PENETRATION | | |
|---------------|---------------------------------|----------|---|------|------|-----------|--------------------------------|---------------|------|------|--------------|------------|--------|------|--------------------|---------|------|
| | | 1 | 2 | Fair | Good | Excellent | | None/Slight | Fair | Good | Maximum 360° | Low | Medium | High | None | Minimal | Some |
| MICROSURFACE* | Latex Nitrile top layer | | ● | | ● | | Good, oily surfaces | ● | | | | | ● | | ● | | |
| MICROSURFACE* | Latex Latex top layer | | ● | | | ● | Good, wet surfaces | ● | | | | | | ● | ● | | |
| MICROSURFACE* | Nitrile | ● | | ● | | | Good, oily surfaces | | ● | | | ● | | | ● | | |
| MICRO-FOAM | Nitrile Proprietary Formulation | ● | | | ● | | Superior, wet or oily surfaces | | | | ● | | | ● | | | ● |
| FOAM | Nitrile | ● | | | ● | | Fair, wet or oily surfaces | | ● | | | | | ● | | | ● |
| NEOFOAM™ | Co-Polymer | ● | | | ● | | Good, wet or oily surfaces | | | ● | | | | ● | | | ● |
| CRINKLE | Latex | ● | | | | ● | Good, wet surfaces | ● | | | | | | ● | ● | | |
| FLAT/SMOOTH | Nitrile | ● | | | | ● | Poor, wet or oily surfaces | ● | | | | | ● | | ● | | |
| FLAT/SMOOTH | Polyurethane | ● | | | ● | | Good, wet or oily surfaces | | ● | | | ● | | | | | ● |

*MicroSurface is equivalent to MicroFinish® by Towa.

COMPLIANCE TESTING

UNDERSTANDING CUT SCORES

UNDERSTANDING CUT SCORES

PIP GLOVES ARE TESTED TO THE ANSI 105 AND THE EN 388 STANDARD.

Both standards test gloves for Abrasion, Cut, Tear and Puncture. While compliance is not mandated in the U.S., safety managers demand that products are tested and labeled in order to select the best possible equipment for the job being performed.

The European Union (EU) developed a standards and regulatory body that requires anyone wanting to sell products in Europe to attain the CE (Conformité Européene) compliance/markings through the performance testing described in EN 388 "Protective Gloves Against Mechanical Risks." EN 388 is widely recognized internationally.

PIP tests all cut resistant gloves at recognized labs and our test facility in Minnesota.

ANSI-105

FOR DETERMINING CUT SCORE ANSI-105-2006 EDITION USES THE ASTM F2992-15 TEST METHOD

TDM-100 TEST

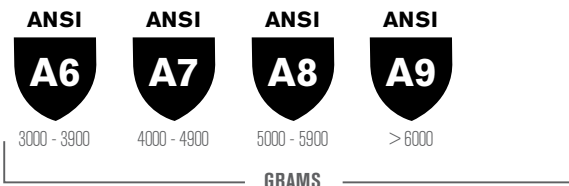
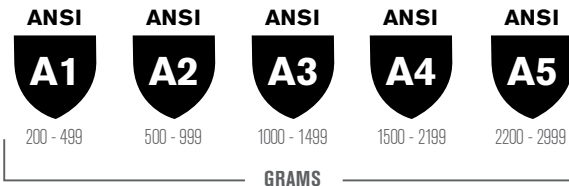
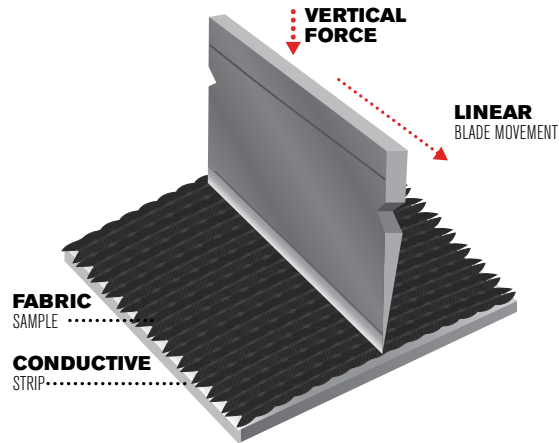

EN 388

FOR DETERMINING CUT SCORE EN 388:2003 CALLS FOR THE EN-COUP TEST

COUP TEST

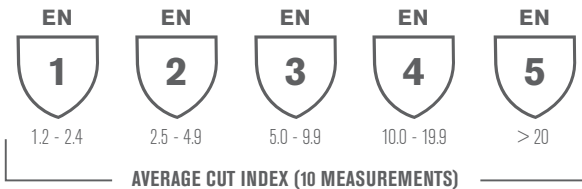
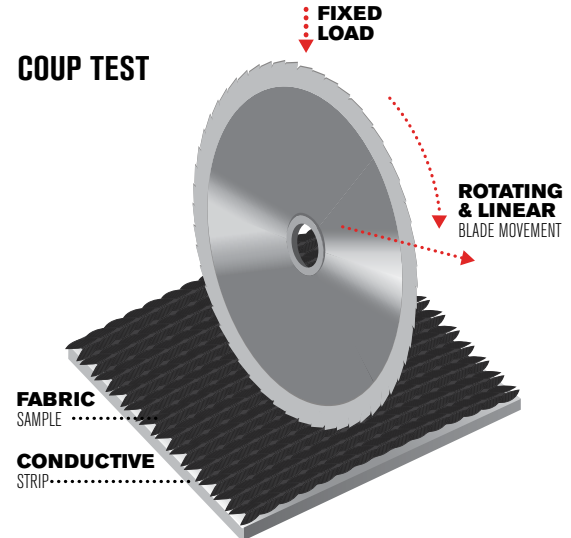

| | EN 388 |
|--------------------|-------------|
| Rating | 4 4 4 2 C X |
| Abrasion | 1-4 |
| Cut (Coup Test) | 1-5 |
| Tear | 1-4 |
| Puncture | 1-4 |
| Cut (TDM-100 Test) | A-F |
| Impact Protection | P, F, X |

P: Passed F: Failed X: Not Tested

EN 388 2016 edition added a second cut test, the ISO 13997 cut method, using the same TDM-100 machine as the ANSI Standard outlined in the ASTM F2992-15 test method. An alpha letter will appear within the new EN Shield indicating this extra score. The letter score will equate closely to the new ANSI score allowing customers to feel more comfortable about the two standards. The updated EN 388 2016 standard will also include an impact resistance test.

SCALE TO DETERMINE CUT SCORES

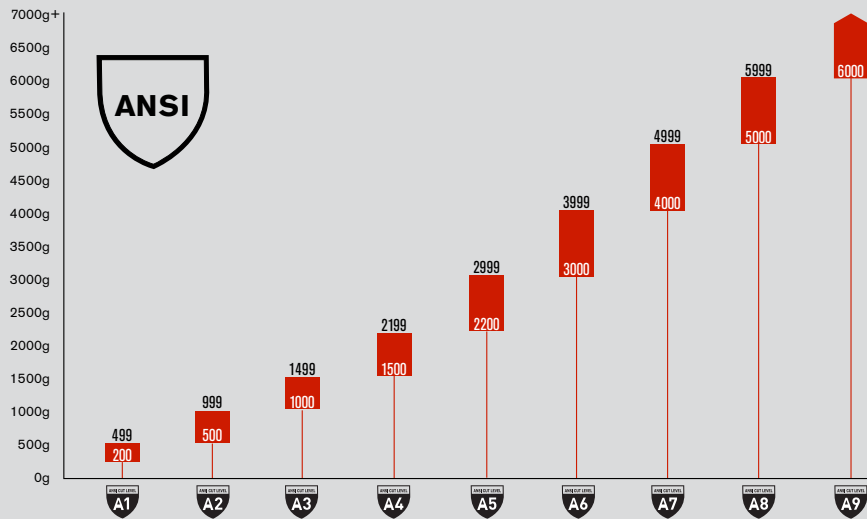

UNDERSTANDING THE ISO 13997 TEST METHOD

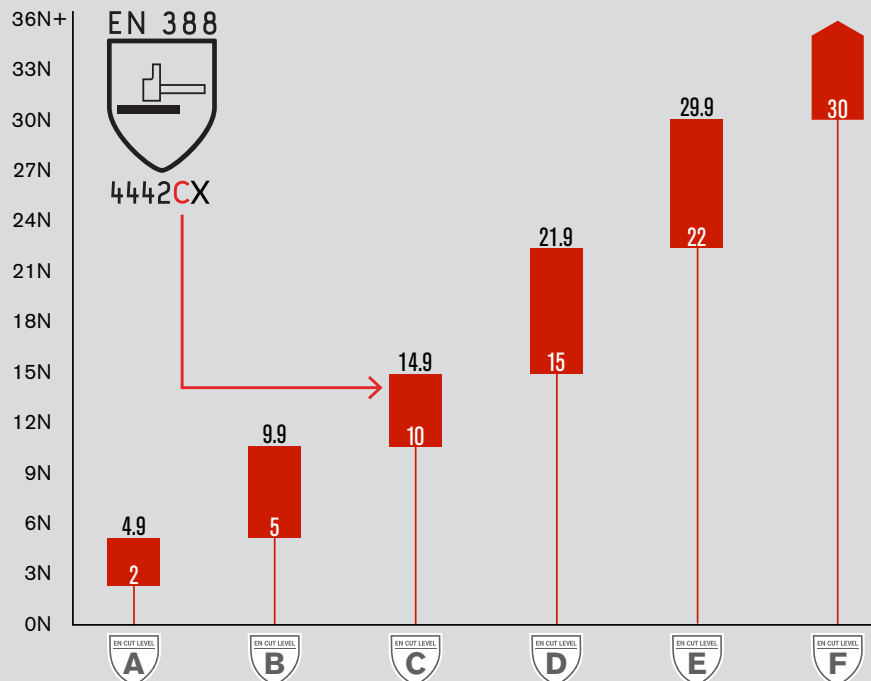

CONVERT

NEWTONS TO GRAMS

PIP has been testing all of its cut resistant gloves with the TDM-100 machine since 2005, which is (and has been) compliant with the new test method, enabling us to easily convert to the new EN 388 2016 standard. The table below illustrates how the new EN 388 2016 standard is now in-line with the ANSI/ISEA 105 standard for cut resistance when converting Newtons to grams.

| EN 388 RATING | RANGE (NEWTONS) | CONVERTED RANGE (GRAMS) | ANSI/ISEA 105 LEVEL | RANGE (GRAMS) |
|----------------|-----------------|-------------------------|---------------------|---------------|
| EN CUT LEVEL A | 2 - 4.9 | 204 - 508 | ANSI CUT LEVEL A1 | 200 - 499 |
| EN CUT LEVEL B | 5 - 9.9 | 509 - 1,019 | ANSI CUT LEVEL A2 | 500 - 999 |
| EN CUT LEVEL C | 10 - 14.9 | 1,020 - 1,529 | ANSI CUT LEVEL A3 | 1,000 - 1,499 |
| EN CUT LEVEL D | 15 - 21.9 | 1,530 - 2,242 | ANSI CUT LEVEL A4 | 1,500 - 2,199 |
| EN CUT LEVEL E | 22 - 29.9 | 2,243 - 3,058 | ANSI CUT LEVEL A5 | 2,200 - 2,999 |
| EN CUT LEVEL F | 30+ | 3,059+ | ANSI CUT LEVEL A6 | 3,000 - 3,999 |
| --- | --- | --- | ANSI CUT LEVEL A7 | 4,000 - 4,999 |
| --- | --- | --- | ANSI CUT LEVEL A8 | 5,000 - 5,999 |
| --- | --- | --- | ANSI CUT LEVEL A9 | 6,000+ |

CUT RISK HAZARD MATRIX™

CHOOSING THE RIGHT PROTECTION



THICKER, TOUGHER COATING

resists tears and protects against abrasion cuts when rough edge contact is part of the task



MAXIMUM GRIP COATING

necessary to prevent slippage and any chance of contact with sharp edges

10
HIGH

FORCE EXPOSURE

LOW
0

LIGHT to MEDIUM CUT HAZARDS

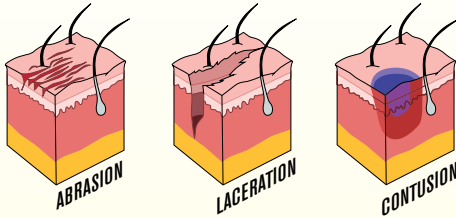

- Low gauge, thicker liner means more fabric loft to absorb and resist abrasion
- Spun yarns loftier to mitigate abrasion effects to skin
- TPR* impact protection to help protect against impact injuries

HIGH CUT HAZARDS



- Medium gauge, thicker liner to absorb pressing edge and allow yarn to roll
- Spun or high strength filament yarns

LIGHT CUT HAZARDS



- Low to medium gauge, thicker liner means more fabric loft to absorb and resist abrasion
- Spun yarns loftier to mitigate abrasion effects to skin

MEDIUM to HIGH CUT HAZARDS

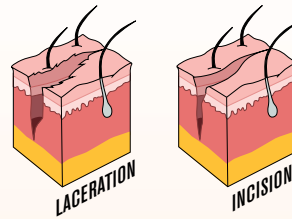

- Higher gauge liner means more yarns per inch
- Filament yarns preferred as sharp edge slides across smooth yarn without catching to cut

0
ROUGH

EDGE SHARPNESS

10
RAZOR

YOUR GUIDE TO THE RIGHT CHOICE

INTRODUCING THE CUT RISK HAZARD MATRIX™

The **Cut Risk Hazard Matrix™** is a unique and logical method to guide users in selecting a glove or sleeve with the right cut resistant material and score. Once a safety manager can identify where their application fits on the **Cut Risk Hazard Matrix™**, they can more confidently correlate the task to the glove or sleeve best suited for their job.



We deemed it necessary to develop a unique approach to help determine the risk and possible severity of an injury.

CALCULATING THE CRH: FACTOR™

1. Assess the **EDGE SHARPNESS** with "Rough" equating to the edge of a brick and "Razor" to that of a sharp knife.
2. **FORCE** is relative to the different tasks being performed. Tasks such as deboning large animals require a high degree of force compared to working with box cutters in a repacking operation.
3. Mapping the two will place you in one of the four quadrants of **RISK** where you can determine your CRH: Factor™ and proceed to selecting the optimal coating for maximum grip.

CUT RISK HAZARD MATRIX™

CHOOSING THE RIGHT PROTECTION



THICKER, TOUGHER COATING
resists tears and protects against abrasion cuts when rough edge contact is part of the task



MAXIMUM GRIP COATING
necessary to prevent slippage and any chance of contact with sharp edges

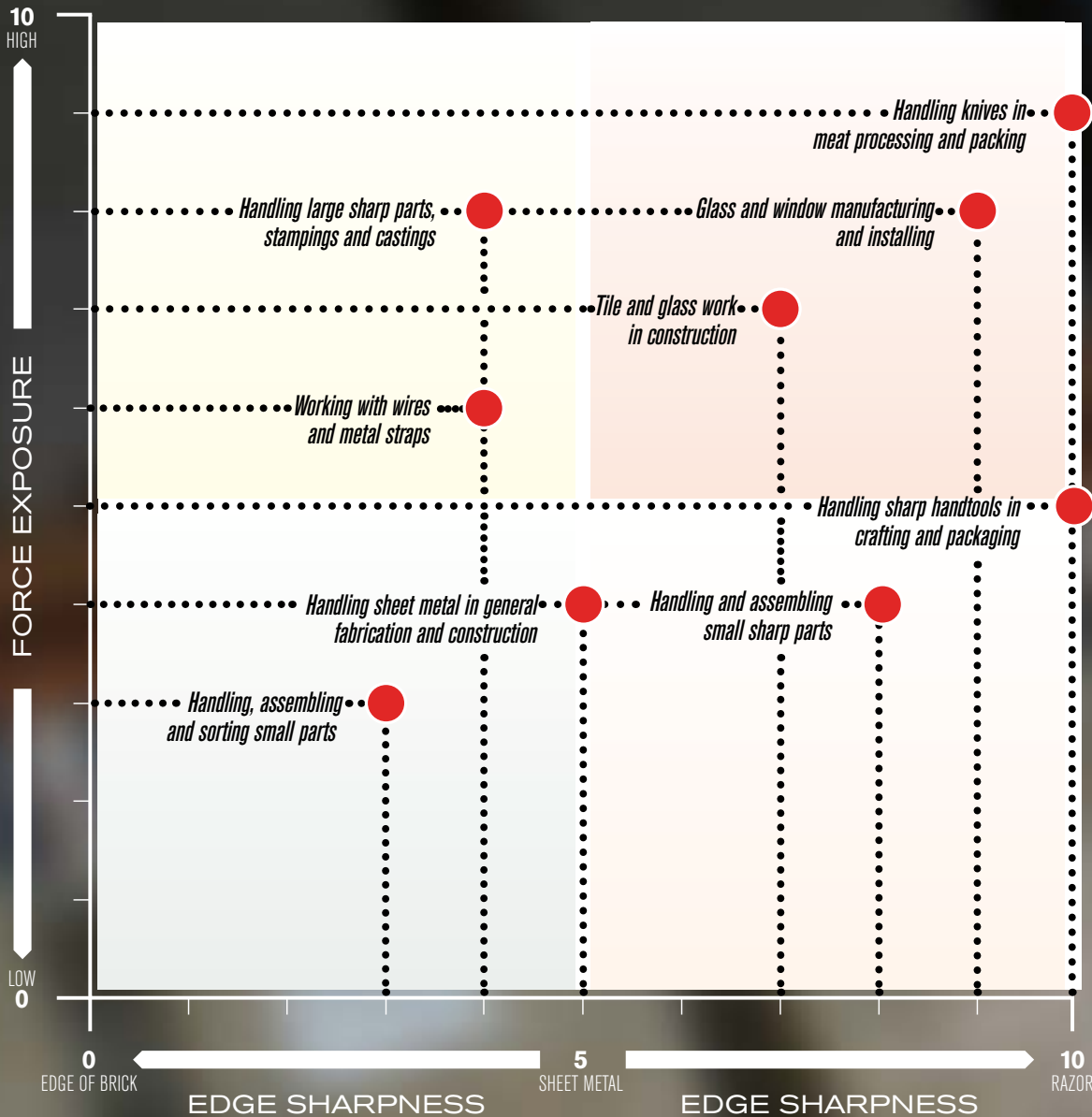

WE'VE EQUATED CUT SCORE FACTORS WITH REAL WORLD TASKS AND APPLICATIONS AS EXAMPLES

By plotting the tasks and applications, we determine a **Cut Risk Hazard Factor™** (CRH: Factor™) as outlined on the right side. The CRH: Factor™ is a comparative indicator that helps safety managers determine the level of potential hazard related to the task or application.

| CRH: FACTOR | TASK |
|-------------|--|
| 9:10 | HANDLING KNIVES IN MEAT PROCESSING AND PACKING |
| 8:9 | GLASS AND WINDOW MANUFACTURING AND INSTALLING |
| 7:7 | TILE AND GLASS WORK IN CONSTRUCTION |
| 8:4 | HANDLING LARGE SHARP PARTS, STAMPINGS AND CASTINGS |
| 6:4 | WORKING WITH WIRES AND METAL STRAPS |
| 5:10 | HANDLING SHARP HANDTOOLS IN CRAFTING AND PACKING |
| 4:8 | HANDLING AND ASSEMBLING SMALL SHARP PARTS |
| 4:5 | HANDLING SHEET METAL IN GENERAL FABRICATION AND CONSTRUCTION |
| 3:3 | HANDLING, ASSEMBLING AND SORTING SMALL PARTS |

Copyright © 2017 Protective Industrial Products, Inc. All rights reserved.

NEW PRODUCTS

COATED SEAMLESS KNIT GLOVES



G-Tek
PolyKor
XRYSTAL™

POLYKOR® XRYSTAL™ IS AN ENGINEERED YARN THAT REPRESENTS THE NEXT GENERATION IN MAXIMUM CUT PROTECTION AND COMFORT.

It is a blend of high-modulus polyethylene and mineral-based fibers. These mineral-based fibers have a similar chemical composition to glass, but are inherently better in terms of strength, heat and oxidation resistance, as well as compression and shear.



G-Tek
Supreme™

A BOLD NEW WORLD OF GRAPHENE-BASED FIBERS.

Similar to graphite, graphene is remarkably strong for its weight – being 100 times stronger than steel – it outperforms any other material. Structurally it is very different than other fibers in that it is made up of micro-structured graphene sheets well-aligned along the fiber axis.



G-Tek
KEV™

KEVLAR® – A UNIQUE COMBINATION OF HIGH STRENGTH, HIGH MODULUS, & THERMAL STABILITY.

From athletes to astronauts, first responders to industrial workers, Kevlar® enables anyone, with an imagination and a job to do, to Dare Bigger™. PIP, the leading provider of coated seamless knit gloves in America teamed up with DuPont® to develop the new G-TEK® KEV™ series of cut resistant gloves.



ATG
Intelligent Glove Solutions

ATG® DESIGNS, DEVELOPS AND MANUFACTURES GLOVES WITH ENHANCED PERFORMANCE

All gloves are skin-friendly, extremely comfortable and highly durable.



ATG® introduces two new cut gloves based on advanced fiber technologies. DuPont™ Kevlar® aramid fiber offers strength and light heat protection and Dyneema® Diamond based super thin liners offers unprecedented strength-to-weight ratio.

NEW CUT PROTECTION FROM PIP

HIGH CUT HAZARDS – INCISION RISK

COATED SEAMLESS KNIT GLOVES

CUT RISK HAZARD MATRIX™

LIGHT to MEDIUM CUT HAZARDS

LIGHT CUT HAZARDS

HIGH CUT HAZARDS

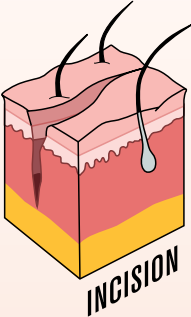

- Medium gauge, thicker liner to absorb pressing edge and allow yarn to roll
- Spun or high strength filament yarns

MEDIUM to HIGH CUT HAZARDS

HIGH CUT HAZARDS INCISION RISK

| STYLE NUMBER | ANSI | EN 388 |
|----------------------------------|------|--------|
| G-TEK® POLYKOR® XRYSTAL™ | | |
| <u>16-X310</u> | A4 | 4544 |
| <u>16-X320</u> | A4 | 4543 |
| <u>16-X540</u> | A4 | 4542 |
| <u>16-X570</u> | A4 | 4542 |
| <u>16-X575</u> | A4 | 4542 |
| G-TEK® SUPRENE™ | | |
| <u>15-210</u> | A4 | 4544 |
| <u>15-215</u> | A4 | 4544 |
| <u>15-340</u> | A4 | 4544 |
| <u>15-440</u> | A4 | 4544 |
| G-TEK® 3GX® | | |
| <u>19-D340LG</u> | A4 | 4544 |
| <u>19-D340OR</u> | A4 | 4544 |
| <u>19-D534B</u> | A4 | 4542 |
| <u>19-D313</u> | A4 | 3544 |
| <u>19-D315</u> | A4 | 3543 |
| <u>19-D526B</u> | A4 | 4542 |
| <u>19-D330</u> | A4 | 4542 |

| STYLE NUMBER | ANSI | EN 388 |
|---------------------------------|------|--------|
| G-TEK® POLYKOR® | | |
| <u>16-560*</u> | A4 | 4543 |
| G-TEK® KEV™ | | |
| <u>09-K1600</u> | A7 | 4543 |
| <u>09-K1640</u> | A4 | 4532 |
| <u>09-K1630</u> | A4 | 4532 |
| <u>73-K1800</u> | A4 | 2542 |
| <u>09-K1300</u> | A4 | 3544 |
| <u>09-K1700</u> | A5 | 3543 |
| ATG® MAXICUT® 5 | | |
| <u>19-D470</u> | A4 | 4543 |
| <u>19-D475</u> | A4 | 4543 |

HIGH CUT HAZARDS – INCISION RISK

COATED SEAMLESS KNIT GLOVES

INCISION
RISK

NEXT GENERATION
MAXIMUM PROTECTION



HIGH CUT HAZARDS – INCISION RISK

COATED SEAMLESS KNIT GLOVES



G-Tek
PolyKor
XRYSTAL™

Represents the latest iteration of PolyKor® in which it is combined with naturally hardened crystallized minerals. The result is a super tough, durable, cut resistant fiber that is at the peak of performance.



ANSI **A4** EN **5** NITRILE MICROSURFACE COATING

G-TEK® POLYKOR® XRYSTAL™ 16-X310

- Tough, flexible coating
- Excellent dry grip, and good grip in oily conditions
- Black coating on gray liner hides dirt

APPLICATIONS: *Electronics, Small Parts Handling, Construction, General Maintenance*



ANSI **A4** EN **5** NITRILE FOAM COATING

G-TEK® POLYKOR® XRYSTAL™ 16-X320

- High tactile and sensitive coating
- Excellent dry grip, and good grip in oily conditions
- Durable & hard-wearing coating
- Black coating on gray liner hides dirt

APPLICATIONS: *Electronics, Sheet Metal Handling, Parts Assembly, General Maintenance*



ANSI **A4** EN **5** NEOFOAM™ COATING

G-TEK® POLYKOR® XRYSTAL™ 16-X570

- Super durable cut resistant fiber
- Good grip on dry, wet or oily surfaces
- Tactile and flexible
- Touchscreen compatible
- Breathable, flexible coating
- Black coating on gray liner hides dirt

APPLICATIONS: *Glass Cutting, Metal Handling, Fastening, Construction*



ANSI **A4** EN **5** POLYURETHANE COATING

G-TEK® POLYKOR® XRYSTAL™ 16-X540

- Thin coating for maximum dexterity and tactile sensitivity
- Good grip on dry, wet or oily surfaces
- Black coating on gray liner hides dirt

APPLICATIONS: *Glass Cutting, Metal Handling, Fastening, Small Sharp Parts Handling, Construction*

PEAK OF CUT PROTECTION

HIGH CUT HAZARDS

| STYLE NUMBER | ANSI | EN 388 | COATING | COATING COVERAGE | COATING COLOR | LINER MATERIAL | LINER COLOR | CONSTRUCTION | GAUGE | SIZES |
|----------------|------|--------|----------------------|-------------------|---------------|--------------------------|-------------|---|-------|----------|
| 16-X310 | A4 | 4544 | Nitrile MicroSurface | Palm & Fingertips | ☐ Black | G-Tek® PolyKor® Xrystal™ | ☐ Gray | Coated Seamless Knit | 13 | XS - XXL |
| 16-X320 | A4 | 4543 | Nitrile Foam | Palm & Fingertips | ☐ Black | G-Tek® PolyKor® Xrystal™ | ☐ Gray | Coated Seamless Knit | 13 | XS - XXL |
| 16-X540 | A4 | 4542 | Polyurethane | Palm & Fingertips | ☐ Black | G-Tek® PolyKor® Xrystal™ | ☐ Gray | Coated Seamless Knit | 13 | XS - XXL |
| 16-X570 | A4 | 4542 | Neof foam™ | Palm & Fingertips | ☐ Black | G-Tek® PolyKor® Xrystal™ | ☐ Gray | Coated Seamless Knit | 13 | XS - XXL |
| 16-X575 | A4 | 4542 | Neof foam™ | Palm & Fingertips | ☐ Black | G-Tek® PolyKor® Xrystal™ | ☐ Gray | Coated Seamless Knit with Reinforced Thumb Crotch | 13 | XS - XXL |

HIGH CUT HAZARDS – INCISION RISK

COATED SEAMLESS KNIT GLOVES

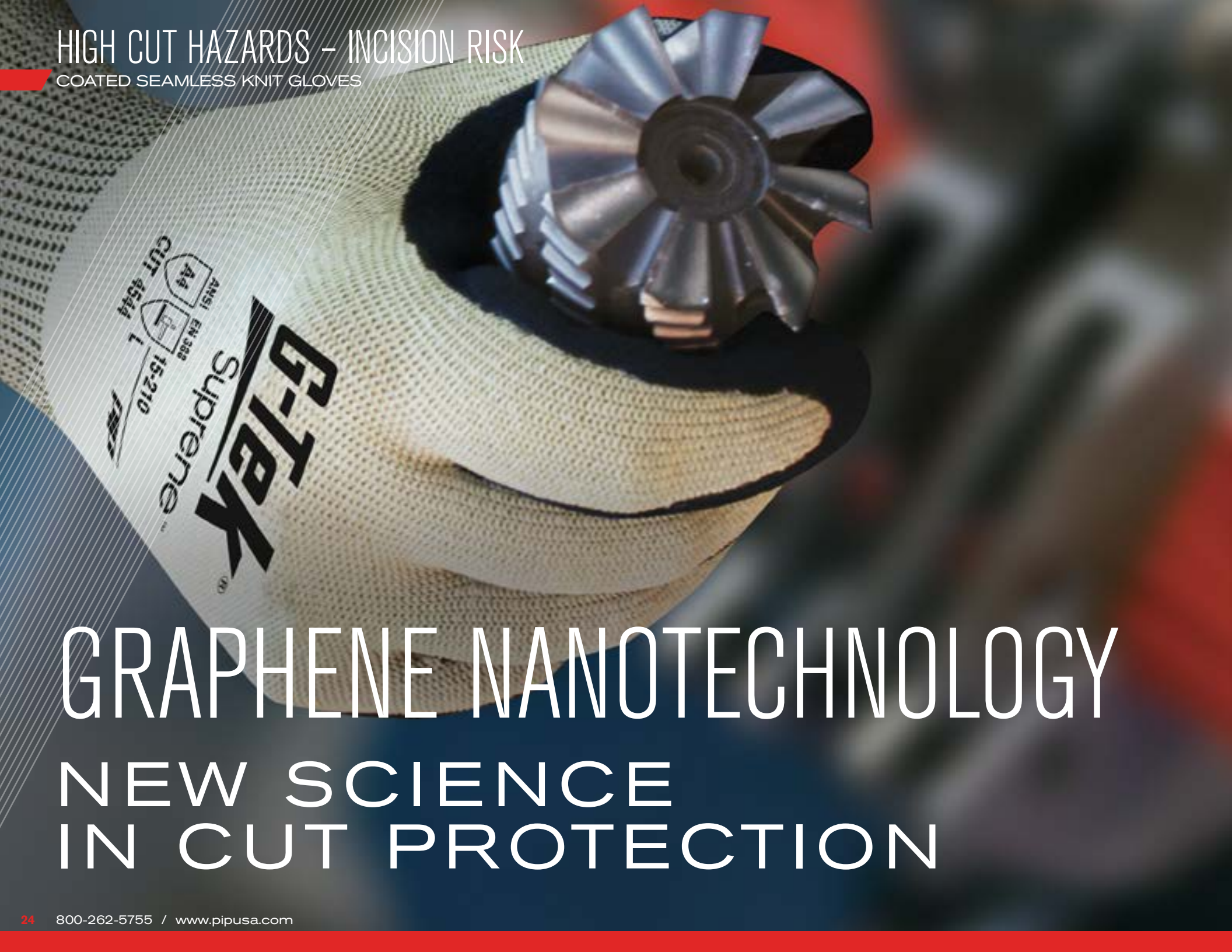

ANSI A4
EN 388
15-210
CUT 4544
1
G-Tek
Supreme

GRAPHENE NANOTECHNOLOGY NEW SCIENCE IN CUT PROTECTION

HIGH CUT HAZARDS – INCISION RISK

COATED SEAMLESS KNIT GLOVES



G-TEK® SUPRENE™ 15-210

- Exceptionally strong liner
- Excellent dry grip, and good grip in oily conditions
- Black coating on gray liner hides dirt

APPLICATIONS: *Electronics, Glass Cutting, Metal Handling, Fastening, General Maintenance*



G-TEK® SUPRENE™ 15-215

- Extended coating coverage for better protection
- Excellent dry grip, and good grip in oily conditions
- Black coating on gray liner hides dirt

APPLICATIONS: *Heavy Duty Industrial, Metal and Castings Handling, Glass and Tile Work, General Maintenance*



G-TEK® SUPRENE™ 15-340

- Thin coating for precision and dexterity
- Good grip in dry, wet, and slightly oily conditions

APPLICATIONS: *Glass Cutting, Metal Handling, Fastening, Construction*



G-TEK® SUPRENE™ 15-440

- High breathability coating for maximum comfort
- Good grip in dry, wet, and slightly oily conditions
- Touchscreen compatible
- Breathable, flexible coating
- Black coating on gray liner hides dirt

APPLICATIONS: *Glass Cutting, Sheet Metal Handling, Fastening, Small Sharp Parts Handling, Construction*

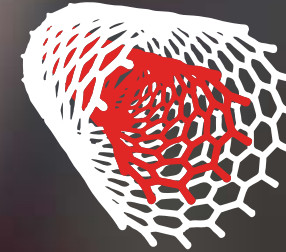

G-Tek®
Suprene™

Latest breakthrough in nanofabrication has resulted in Suprene™ – an affordable fiber with unparalleled strength and physical properties.

UNPARALLELED STRENGTH

HIGH CUT HAZARDS

| STYLE NUMBER | ANSI | EN 388 | COATING | COATING COVERAGE | COATING COLOR | LINER MATERIAL | LINER COLOR | CONSTRUCTION | GAUGE | SIZES |
|------------------------|------|--------|----------------------|-----------------------------|---------------|-----------------|-------------|----------------------|-------|----------|
| 15-210 | A4 | 4544 | Nitrile MicroSurface | Palm & Fingertips | ■ Black | G-Tek® Suprene™ | ■ Tan | Coated Seamless Knit | 13 | XS - XXL |
| 15-215 | A4 | 4544 | Nitrile MicroSurface | Palm, Full Finger & Knuckle | ■ Black | G-Tek® Suprene™ | ■ Tan | Coated Seamless Knit | 13 | XS - XXL |
| 15-340 | A4 | 4544 | Polyurethane | Palm & Fingertips | ■ Gray | G-Tek® Suprene™ | ■ Tan | Coated Seamless Knit | 13 | XS - XXL |
| 15-440 | A4 | 4544 | Neofoam™ | Palm & Fingertips | ■ Black | G-Tek® Suprene™ | ■ Tan | Coated Seamless Knit | 13 | XS - XXL |

HIGH CUT HAZARDS – INCISION RISK

COATED SEAMLESS KNIT GLOVES

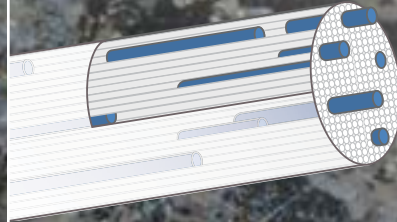

G-Tek[®] 3GX[®]

Embedded micro-particles strengthen fibers by up to two times, for higher cut scores. 3GX[®] offers cool touch comfort and are lightweight for improved productivity.



ANSI **A4** EN **5** NITRILE FOAM COATING

**G-TEK[®] 3GX[®]
19-D340LG**

- High tactile sensitivity and dexterity
- Excellent dry grip and resistance to oils
- High puncture resistance for industrial applications
- Excellent durability

APPLICATIONS: *Handling Metal Parts, Assembly, Fastening, Industrial Construction*



HEAVY DUTY

ANSI **A4** EN **5** LATEX CRINKLE COATING

**G-TEK[®] 3GX[®]
19-D313**

- Heavy duty, tough wearing performance
- Superior grip in dry and slightly wet, non-oily conditions
- High puncture resistance
- Good durability

APPLICATIONS: *Ceramics, Glass and Sheet Metal Handling, Construction, General Maintenance*

STRONGER. SAFER. BETTER. CUT PROTECTION WITH DYNEEMA[®] DIAMOND TECHNOLOGY

HIGH CUT HAZARDS – INCISION RISK

COATED SEAMLESS KNIT GLOVES



HI-VISIBILITY



**G-TEK® 3GX®
19-D340OR**

- High tactile sensitivity and dexterity
- Excellent dry grip and resistance to oils
- High puncture resistance for industrial applications
- Excellent durability

APPLICATIONS: *Handling Metal Parts, Assembly, Fastening, Industrial Construction*



**G-TEK® 3GX® BLACK
19-D534B**

- Tough wearing, oil and solvent resistant coating
- Good cut protection and tactility
- Good dry grip, fair grip in oily conditions

APPLICATIONS: *Glass Cutting, Construction, Fastening, Metal and Castings, General Maintenance*

G-TEK® 3GX® WITH DYNEEMA® DIAMOND TECHNOLOGY



**G-TEK® 3GX® BLACK
19-D526B**

- Black liner hides dirt and extends life of glove
- Good cut protection and tactility
- Good grip in dry, wet and slightly oily conditions

APPLICATIONS: *Electronics, Glass Cutting, Metal Handling, General Maintenance, Small Parts Handling*



**G-TEK® 3GX®
19-D330**

- High tactile sensitivity and dexterity
- Good grip in dry, wet, and slightly oily conditions
- Excellent durability

APPLICATIONS: *Electronics and Metal Assembly, Small Sharp Parts Handling*

HIGH CUT HAZARDS

| STYLE NUMBER | ANSI | EN 388 | COATING | COATING COVERAGE | COATING COLOR | LINER MATERIAL | LINER COLOR | CONSTRUCTION | GAUGE | SIZES |
|------------------|------|--------|---------------|-------------------|---------------|-----------------|---------------|----------------------|-------|-----------|
| 19-D340LG | A4 | 4544 | Nitrile Foam | Palm & Fingertips | Black | G-Tek® 3GX® | Hi-Vis Lime | Coated Seamless Knit | 13 | XS - XXL |
| 19-D340OR | A4 | 4544 | Nitrile Foam | Palm & Fingertips | Black | G-Tek® 3GX® | Hi-Vis Orange | Coated Seamless Knit | 13 | XS - XXL |
| 19-D534B | A4 | 4542 | Nitrile Foam | Palm & Fingertips | Black | G-Tek® 3GX® | Black | Coated Seamless Knit | 15 | S - XL |
| 19-D313 | A4 | 3544 | Latex Crinkle | Palm & Fingertips | Blue | G-Tek® 3GX® | White | Coated Seamless Knit | 13 | S - XL |
| 19-D315 | A4 | 3543 | Latex Crinkle | Palm & Fingertips | Blue | G-Tek® 3GX® | White | Coated Seamless Knit | 15 | S - XL |
| 19-D526B | A4 | 4542 | Polyurethane | Palm & Fingertips | Black | G-Tek® 3GX® | Black | Coated Seamless Knit | 15 | XS - XXL |
| 19-D330 | A4 | 4542 | Polyurethane | Palm & Fingertips | Gray | G-Tek® 3GX® | White | Coated Seamless Knit | 13 | XS - XXXL |
| 16-560 | A4 | 4543 | Polyurethane | Palm & Fingertips | Gray | G-Tek® PolyKor® | Gray | Coated Seamless Knit | 13 | XS - XXL |

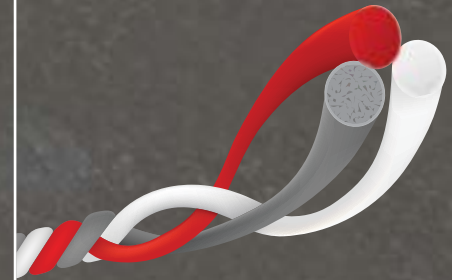

G-Tek®
PolyKor®

PolyKor® Engineered Yarns optimize performance, function, and protection using proprietary blends of select fibers to exceed industry standards. The ultimate objective is affordable cut resistant gloves for practically every application.

PROVEN & TRUSTED



**G-TEK® POLYKOR®
16-560**

- High tactile sensitivity and dexterity
- Good grip in dry, wet, and slightly oily conditions
- Good puncture resistance for industrial applications
- Excellent durability

APPLICATIONS: *Electronics, Glass Cutting, Metal Handling, Fastening, Construction*

HIGH CUT HAZARDS – INCISION RISK

COATED SEAMLESS KNIT GLOVES



Kevlar.

DARE  BIGGER™

MAXIMUM CUT PROTECTION



ANSI
A7

EN
5

NITRILE FOAM
COATING 

**G-TEK® KEV™
09-K1600**

- Superior cut resistance
- Good grip on dry, wet or oily surfaces
- Protection in light heat applications

APPLICATIONS: *Glass Cutting, Metal Handling, Fastening, Construction*



ANSI
A4

EN
5

NITRILE FOAM
COATING 

**G-TEK® KEV™
09-K1640**

- Red liner for easy compliance detection on job site
- Good grip on dry, wet or oily surfaces
- Protection in light heat applications

APPLICATIONS: *Glass Cutting, Metal Handling, Small Sharp Parts Handling, Fastening*



ANSI
A4

EN
5

LATEX CRINKLE
COATING 

**G-TEK® KEV™
09-K1300**

- Excellent grip in dry and wet, non-oily conditions
- Fully coated thumb to increase wear
- High puncture resistance
- Good durability

APPLICATIONS: *Ceramics, Glass Cutting, Metal Handling, General Maintenance*

TOUGH WEARING



ANSI
A5

EN
5

LATEX MICROFINISH®
COATING 

09-K1700

- Excellent grip in dry and wet, non-oily conditions
- Steel core Kevlar® liner for additional cut protection
- Good puncture resistance
- Good durability

APPLICATIONS: *Ceramics, Glass Cutting, Metal Handling, General Maintenance*

STEEL CORE KEVLAR®

THE POWER OF KEVLAR®

CUT & HEAT PROTECTION

HIGH CUT HAZARDS – INCISION RISK

COATED SEAMLESS KNIT GLOVES



ANSI **A4** EN **5** NITRILE FOAM COATING

- G-TEK® KEV™ 09-K1630**
- Excellent durability and abrasion resistance
 - Good grip on dry, wet or oily surfaces
 - Protection in light heat applications

APPLICATIONS: Metal Handling, Fastening, Construction, General Maintenance



ANSI **A4** EN **5** NITRILE FOAM COATING

- MAXIMUM SAFETY® 73-K1800**
- Arc rated with high cut protection
 - Seamless knit aramid liner is comfortable and flexible
 - Nitrile coated palm and finger tips for enhanced grip

APPLICATIONS: Oil and Gas Protection Against Arc and Flash Fires

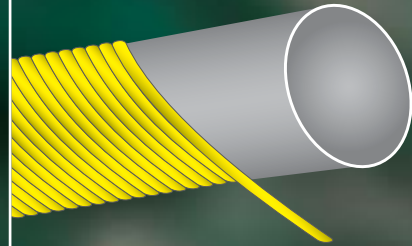

Takes the power of DuPont™ Kevlar® and combines it with proprietary core technology for maximum cut strength and protection in light heat applications.



DEFYING LIMITS

CHALLENGING THE CONVENTIONAL

PIP data demonstrates that more often than not arm protection is left to long-sleeved daily work wear. **This is not protection.** Only a Kut Gard® sleeve designed and conforming to the latest cut standards will do the job.

KUT GARD® MADE WITH KEVLAR® SLEEVES

| STYLE NUMBER | ANSI | COLOR | CONSTRUCTION | PLY | LENGTHS |
|------------------|------|----------------|--------------|-----|----------|
| 10-KVSRD | A6 | Red | Blousy | 1 | 12", 18" |
| 10-KVSDGH | A6 | Dark Gray | Blousy | 1 | 12", 18" |
| 10-KVSYBH | A6 | Yellow / Black | Blousy | 1 | 12", 18" |

HIGH CUT HAZARDS

| STYLE NUMBER | ANSI | EN 388 | COATING | COATING COVERAGE | COATING COLOR | LINER MATERIAL | LINER COLOR | CONSTRUCTION | GAUGE | SIZES |
|-----------------|------|--------|--------------------|-------------------|---------------|-----------------|----------------|----------------------|-------|---------|
| 09-K1600 | A7 | 4543 | Nitrile Foam | Palm & Fingertips | Black | G-Tek® KEV™ | Yellow / Black | Coated Seamless Knit | 13 | S - XXL |
| 09-K1640 | A4 | 4532 | Nitrile Foam | Palm & Fingertips | Black | G-Tek® KEV™ | Red | Coated Seamless Knit | 13 | S - XXL |
| 09-K1630 | A4 | 4532 | Nitrile Foam | Palm & Fingertips | Black | G-Tek® KEV™ | Gray | Coated Seamless Knit | 13 | S - XXL |
| 73-K1800 | A4 | 2542 | Nitrile Foam | Palm & Fingertips | Black | Aramid | Yellow | Coated Seamless Knit | 13 | S - XXL |
| 09-K1300 | A4 | 3544 | Latex Crinkle | Palm & Fingertips | Blue | G-Tek® KEV™ | Yellow | Coated Seamless Knit | 10 | S - XXL |
| 09-K1700 | A5 | 3543 | Latex MicroFinish® | Palm & Fingertips | Blue | DuPont™ Kevlar® | Yellow | Coated Seamless Knit | 10 | S - XXL |

HIGH CUT HAZARDS – INCISION RISK

COATED SEAMLESS KNIT GLOVES



BREATHABLE CUT RESISTANCE



▲ 19-D470

▲ 19-D475



MAXICUT® 5

- Good dexterity and tactility
- Patented micro-foam nitrile coating offers 360° breathability
- Excellent dry grip and compatibility with light oils
- Thumb reinforcement for durability
- Good puncture resistance
- Excellent durability

APPLICATIONS: Electronics, Metal Handling, Small Sharp Parts Handling, Maintenance, Repair

HIGH CUT HAZARDS

| STYLE NUMBER | ANSI | EN 388 | COATING | COATING COVERAGE | COATING COLOR | LINER MATERIAL | LINER COLOR | CONSTRUCTION | GAUGE | SIZES |
|----------------|------|--------|--------------------|-----------------------------|---------------|-----------------|-------------|----------------------|-------|----------|
| 19-D470 | A4 | 4543 | Nitrile Micro-Foam | Palm & Fingertips | ■ Gray | Engineered Yarn | ■ Gray | Coated Seamless Knit | 13 | XS - XXL |
| 19-D475 | A4 | 4543 | Nitrile Micro-Foam | Palm, Full Finger & Knuckle | ■ Gray | Engineered Yarn | ■ Gray | Coated Seamless Knit | 13 | XS - XXL |

COMFORT & PERFORMANCE

MEDIUM TO HIGH CUT HAZARDS – LACERATION & INCISION RISK

COATED SEAMLESS KNIT GLOVES

LIGHT to MEDIUM
CUT HAZARDS

HIGH
CUT HAZARDS

MEDIUM TO HIGH CUT HAZARDS

LACERATION & INCISION RISK

LIGHT
CUT HAZARDS

MEDIUM to HIGH CUT HAZARDS

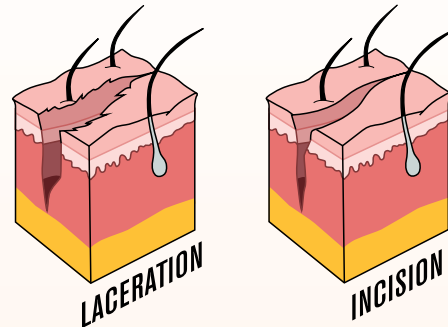

- Higher gauge liner means more yarns per inch
- Filament yarns preferred as sharp edge slides across smooth yarn without catching to cut

CRH MATRIX™

| STYLE NUMBER | ANSI | EN 388 |
|---------------------------------|------|--------|
| G-TEK® 3GX® | | |
| <u>19-D334</u> | A3 | 4443 |
| <u>19-D355</u> | A3 | 4343 |
| <u>19-D322</u> | A3 | 4442 |
| <u>19-D320</u> | A3 | 4442 |
| <u>19-D310</u> | A3 | 4442 |
| <u>19-D325</u> | A3 | 4542 |
| <u>19-D326</u> | A3 | 4442 |
| <u>19-D360</u> | A3 | 4442 |
| <u>19-D327</u> | A3 | 4542 |
| G-TEK® POLYKOR® | | |
| <u>16-340LG</u> | A3 | 4544 |
| <u>16-340OR</u> | A3 | 4544 |
| <u>16-350</u> | A3 | 4543 |
| <u>16-520HY</u> | A3 | 4542 |
| <u>16-815</u> | A3 | 3543 |
| <u>16-747</u> | A3 | 3341 |
| <u>16-820</u> | A3 | 2543 |

| STYLE NUMBER | ANSI | EN 388 |
|---------------------------------|------|--------|
| G-TEK® KEV™ | | |
| <u>09-K1618</u> | A3 | 4421 |
| <u>09-K1350</u> | A3 | 2342 |
| <u>09-K1444</u> | A3 | 2444 |
| <u>09-K1310</u> | A3 | 2444 |
| <u>09-K1218</u> | A3 | 4331 |
| ATG® MAXICUT® ULTRA™ | | |
| <u>44-3745</u> | A3 | 4542 |
| <u>44-3755</u> | A3 | 4542 |
| <u>44-3445</u> | A3 | 4542 |
| <u>44-3455</u> | A3 | 4542 |
| <u>44-1745</u> | A3 | 4542 |
| <u>44-6745</u> | A3 | 4542 |

MEDIUM TO HIGH CUT HAZARDS – LACERATION & INCISION RISK

COATED SEAMLESS KNIT GLOVES

LACERATION
INCISION
RISK

GREAT WHITE
3GX
ANSI A3 EN 388
CUT 4442 L 19-D322
PIP

G-Tek[®]
3GX[®]

REDEFINE[®]
CUT PROTECTION



MEDIUM TO HIGH CUT HAZARDS – LACERATION & INCISION RISK

COATED SEAMLESS KNIT GLOVES



HIDES DIRT



**G-TEK® 3GX®
19-D334**

- High tactile sensitivity and dexterity
- Excellent dry grip and resistance to oils
- Liner and dark coating hides dirt
- Good puncture resistance
- Excellent durability

APPLICATIONS: *Handling Metal Parts, Assembly, Fastening, Industrial, Construction*



ENHANCED PROTECTION



**G-TEK® 3GX®
19-D355**

- High tactile sensitivity and dexterity
- Excellent dry grip and resistance to oils
- Dark colors hides dirt
- Greater coating coverage for enhanced abrasion and liquid protection
- Good puncture resistance
- Excellent durability

APPLICATIONS: *Heavy Duty Handling Metal Parts, Assembly, Fastening Industrial, Construction*



BEST SELLER



**G-TEK®
GREAT WHITE® 3GX®
19-D322**

- High tactile sensitivity and dexterity
- Good grip in dry, wet, and slightly oily conditions
- Excellent durability

APPLICATIONS: *Electronics Assembly, Metal Handling, Small and Medium Sharp Parts Handling, Industrial, Construction*



**G-TEK® 3GX®
19-D320**

- High tactile sensitivity and dexterity
- Good grip in dry, wet, and slightly oily conditions
- Gray coating on gray liner hides dirt
- Excellent durability

APPLICATIONS: *Electronics Assembly, Metal Handling, Small and Medium Sharp Parts Handling, Maintenance, Repair*



FOR CLEAN WORK



**G-TEK® 3GX®
19-D325**

- High tactile sensitivity and dexterity
- Good grip in dry, wet, and slightly oily conditions
- White coating on white liner ideal for cleaner work
- Excellent durability

APPLICATIONS: *Electronics Assembly, Metal Handling, Small and Medium Sharp Parts Handling*



**G-TEK® 3GX®
19-D326**

- High tactile sensitivity and dexterity
- Good grip in dry, wet, and slightly oily conditions
- Excellent durability

APPLICATIONS: *Electronics Assembly, Metal Handling, Small and Medium Sharp Parts Handling, Maintenance, Repair*



HIDES DIRT



**G-TEK® 3GX®
19-D327**

- Excellent tactile sensitivity and dexterity
- Good grip in dry, wet, and slightly oily conditions
- Gray coating on gray liner hides dirt
- Excellent durability

APPLICATIONS: *Electronics Assembly, Metal Handling, Small Sharp Parts Handling, Maintenance, Repair Operations*

MEDIUM TO HIGH CUT HAZARDS

| STYLE NUMBER | ANSI | EN 388 | COATING | COATING COVERAGE | COATING COLOR | LINER MATERIAL | LINER COLOR | CONSTRUCTION | GAUGE | SIZES |
|----------------|------|--------|--------------|-----------------------------|---------------|----------------|---------------|----------------------|-------|-----------|
| 19-D334 | A3 | 4443 | Nitrile Foam | Palm & Fingertips | Black | G-Tek® 3GX® | Salt & Pepper | Coated Seamless Knit | 13 | S - XL |
| 19-D355 | A3 | 4343 | Nitrile Foam | Palm, Full Finger & Knuckle | Black | G-Tek® 3GX® | Salt & Pepper | Coated Seamless Knit | 13 | S - XL |
| 19-D322 | A3 | 4442 | Polyurethane | Palm & Fingertips | Gray | G-Tek® 3GX® | White | Coated Seamless Knit | 13 | XS - XXL |
| 19-D320 | A3 | 4442 | Polyurethane | Palm & Fingertips | Gray | G-Tek® 3GX® | Gray | Coated Seamless Knit | 13 | XS - XXL |
| 19-D310 | A3 | 4442 | Polyurethane | Palm & Fingertips | Gray | G-Tek® 3GX® | White | Coated Seamless Knit | 13 | XS - XXL |
| 19-D325 | A3 | 4542 | Polyurethane | Palm & Fingertips | White | G-Tek® 3GX® | White | Coated Seamless Knit | 13 | XXS - XXL |
| 19-D326 | A3 | 4442 | Polyurethane | Palm & Fingertips | Black | G-Tek® 3GX® | Salt & Pepper | Coated Seamless Knit | 13 | XS - XXL |
| 19-D360 | A3 | 4442 | Polyurethane | Palm & Fingertips | Gray | G-Tek® 3GX® | Gray | Coated Seamless Knit | 13 | S - XL |
| 19-D327 | A3 | 4542 | Polyurethane | Palm & Fingertips | Gray | G-Tek® 3GX® | Gray | Coated Seamless Knit | 15 | XS - XXL |

MEDIUM TO HIGH CUT HAZARDS – LACERATION & INCISION RISK

COATED SEAMLESS KNIT GLOVES



HI-VISIBILITY



**G-TEK® POLYKOR®
16-340LG**

- High tactile sensitivity and dexterity
- Excellent dry grip and resistance to oils
- Hi-Vis for enhanced hand visibility
- Good puncture resistance
- Excellent durability
- Double-dipped coating for added wear protection

APPLICATIONS: *Electronics, Glass Cutting, Metal Handling, Fastening, Construction*



HIDES DIRT



**G-TEK® POLYKOR®
16-350**

- High tactile sensitivity and dexterity
- Excellent dry grip and resistance to oils
- Better comfort against skin
- Good puncture resistance
- Excellent durability
- Double-dipped coating for added wear protection

APPLICATIONS: *Electronics, Sheet Metal Handling, Parts Assembly, Small Sharp Parts Handling, Construction, Maintenance*



HI-VISIBILITY



EASY COMPLIANCE

**G-TEK® POLYKOR®
16-520HY**

- High tactile sensitivity and dexterity
- Good grip in dry, wet, and slightly oily conditions
- Hi-Vis yellow for easy compliance detection

APPLICATIONS: *Electronics, Metal Handling, Fastening, Construction*



DOUBLE-DIPPED COATING



**G-TEK® POLYKOR®
16-815**

- High tactile sensitivity and dexterity
- Excellent grip in dry and wet, non-oily conditions
- Better comfort against skin
- Good puncture resistance
- Good durability
- Double-dipped coating for added wear protection

APPLICATIONS: *Ceramics, Glass Cutting, Metal Handling, General Maintenance*



16-747

- Good cut resistance
- Good grip in greasy or oily conditions
- Black coating and liner hides dirt

APPLICATIONS: *Metal Handling, Fastening, Assembly, Construction*



ALL WEATHER GLOVE

**G-TEK® POLYKOR®
16-820**

- High tactile sensitivity and dexterity
- Excellent grip in dry and wet, non-oily conditions
- Better comfort against skin
- Greater coating coverage for enhanced protection
- Inner acrylic liner for cold weather use
- Good puncture resistance

APPLICATIONS: *Ceramics, Glass Cutting, Metal Handling, General Maintenance, Construction*

PROTECTION. PERFORMANCE. VALUE.



MEDIUM TO HIGH CUT HAZARDS

| STYLE NUMBER | ANSI | EN 388 | COATING | COATING COVERAGE | COATING COLOR | LINER MATERIAL | LINER COLOR | CONSTRUCTION | GAUGE | SIZES |
|-----------------|------|--------|----------------------|-----------------------------|---------------|-----------------|-----------------|----------------------|-------|----------|
| 16-340LG | A3 | 4544 | Nitrile MicroSurface | Palm & Fingertips | ☐ Black | G-Tek® PolyKor® | ■ Hi-Vis Lime | Coated Seamless Knit | 13 | S - XXL |
| 16-340OR | A3 | 4544 | Nitrile MicroSurface | Palm & Fingertips | ☐ Black | G-Tek® PolyKor® | ■ Hi-Vis Orange | Coated Seamless Knit | 13 | S - XXL |
| 16-350 | A3 | 4543 | Nitrile MicroSurface | Palm & Fingertips | ☐ Black | G-Tek® PolyKor® | ■ Salt & Pepper | Coated Seamless Knit | 13 | XS - XXL |
| 16-520HY | A3 | 4542 | Polyurethane | Palm & Fingertips | ■ Hi-Vis Lime | G-Tek® PolyKor® | ■ Hi-Vis Lime | Coated Seamless Knit | 13 | XS - XXL |
| 16-815 | A3 | 3543 | Latex MicroSurface | Palm & Fingertips | ☐ Black | G-Tek® PolyKor® | ■ Salt & Pepper | Coated Seamless Knit | 13 | XS - XXL |
| 16-747 | A3 | 3341 | PVC | Palm & Fingertips | ☐ Black | PolyKor® Blend | ☐ Black | Coated Seamless Knit | 13 | XS - XXL |
| 16-820 | A3 | 2543 | Latex MicroSurface | Palm, Full Finger & Knuckle | ☐ Black | G-Tek® PolyKor® | ■ Salt & Pepper | Coated Seamless Knit | 13 | S - XXL |

MEDIUM TO HIGH CUT HAZARDS – LACERATION & INCISION RISK

COATED SEAMLESS KNIT GLOVES



ANSI **A3** EN **4** NITRILE FOAM COATING

G-TEK® KEV™ 09-K1618

- Thin coating for maximum dexterity
- Excellent dry grip, and good grip on wet or oily surfaces
- Protection in light heat applications

APPLICATIONS: *Glass Cutting, Electronics, Metal Handling, Fastening, Construction*



STAY WARM

ANSI **A3** EN **3** LATEX MICROFINISH® COATING

09-K1350

- Excellent grip in dry and wet, non-oily conditions
- Fully coated thumb to increase wear
- Acrylic blended Kevlar® shell to provide warmth in cold environments

APPLICATIONS: *Ceramics, Glass Cutting, Metal Handling, General Maintenance, Cold Protection*



EXCELLENT DRY GRIP

ANSI **A3** EN **4** LATEX MICROFINISH® COATING

09-K1444

- Excellent grip in dry and wet, non-oily conditions
- High puncture resistance
- Fully coated thumb to increase wear

APPLICATIONS: *Ceramics, Glass Cutting, Metal Handling, General Maintenance*



ANSI **A3** EN **4** LATEX CRINKLE COATING

09-K1310

- Excellent grip in dry and wet, non-oily conditions
- Fully coated thumb to increase wear
- High puncture resistance

APPLICATIONS: *Ceramics, Glass Cutting, Metal Handling, General Maintenance*



ANSI **A3** EN **3** NEOFOAM™ COATING

G-TEK® KEV™ 09-K1218

- High breathability and comfort
- Excellent dry grip, and good grip in oily conditions
- Protection in light heat applications

APPLICATIONS: *Glass Cutting, Metal Parts, Fastening, Construction*



CUT & HEAT PROTECTION



Kevlar.

DARE < BIGGER™

MEDIUM TO HIGH CUT HAZARDS

| STYLE NUMBER | ANSI | EN 388 | COATING | COATING COVERAGE | COATING COLOR | LINER MATERIAL | LINER COLOR | CONSTRUCTION | GAUGE | SIZES |
|-----------------|------|--------|--------------------|-------------------|---------------|-----------------|-------------|----------------------|-------|---------|
| 09-K1618 | A3 | 4421 | Nitrile Foam | Palm & Fingertips | ☐ Black | G-Tek® KEV™ | ☐ Gray | Coated Seamless Knit | 18 | S - XXL |
| 09-K1350 | A3 | 2342 | Latex MicroFinish® | Palm & Fingertips | ■ Brown | DuPont™ Kevlar® | ■ Yellow | Coated Seamless Knit | 10 | S - XXL |
| 09-K1444 | A3 | 2444 | Latex MicroFinish® | Palm & Fingertips | ■ Blue | DuPont™ Kevlar® | ■ Yellow | Coated Seamless Knit | 10 | S - XXL |
| 09-K1310 | A3 | 2444 | Latex Crinkle | Palm & Fingertips | ■ Blue | DuPont™ Kevlar® | ■ Yellow | Coated Seamless Knit | 10 | S - XL |
| 09-K1218 | A3 | 4331 | Neof foam™ | Palm & Fingertips | ☐ Black | G-Tek® KEV™ | ☐ Gray | Coated Seamless Knit | 18 | S - XXL |

MEDIUM TO HIGH CUT HAZARDS – LACERATION & INCISION RISK

COATED SEAMLESS KNIT GLOVES



CUT PROTECTION AND MAXIMUM COMFORT



▲ 44-3745



MAXICUT® ULTRA™

- High tactile sensitivity and dexterity
- Patented Micro-Foam nitrile coating offers 360° breathability for increased comfort
- Micro-cup finish provides excellent dry grip and compatibility with light oils
- Thumb reinforcement for durability
- Excellent durability

APPLICATIONS: Handling Ceramics, Corrugated Sheets, Non-Deburred Parts, Glass Panels, Plastics Injection Moulds, Sharp Edged Metal Sheets, Small Sharp Components, Logistics, Warehousing, Maintenance, Primary, Secondary and Final Assembly



▲ 44-3445



▲ 44-1745



▲ 44-6745

MEDIUM TO HIGH CUT HAZARDS

| STYLE NUMBER | ANSI | EN 388 | COATING | COATING COVERAGE | COATING COLOR | LINER MATERIAL | LINER COLOR | CONSTRUCTION | GAUGE | SIZES |
|--------------|------|--------|--------------------|-----------------------------|---------------|-----------------------------|--------------|----------------------|-------|----------|
| 44-3745 | A3 | 4542 | Nitrile Micro-Foam | Palm & Fingertips | □ Black | Engineered Yarn | ■ Blue | Coated Seamless Knit | 15 | XS - XXL |
| 44-3755 | A3 | 4542 | Nitrile Micro-Foam | Palm, Full Finger & Knuckle | □ Black | Engineered Yarn | ■ Blue | Coated Seamless Knit | 15 | XS - XXL |
| 44-1745 | A3 | 4542 | Nitrile Micro-Foam | Palm & Fingertips | □ Black | DuPont™ Kevlar® | ■ Yellow | Coated Seamless Knit | 15 | S - XXL |
| 44-6745 | A3 | 4542 | Nitrile Micro-Foam | Palm & Fingertips | □ Black | Dyneema® Diamond Technology | ■ Light Blue | Coated Seamless Knit | 15 | S - XXL |

MEDIUM TO HIGH CUT HAZARDS – MAXICUT® ULTRA DT™

| | | | | | | | | | | |
|---------|----|------|--------------------|--|---------|-----------------|--------|----------------------|----|----------|
| 44-3445 | A3 | 4542 | Nitrile Micro-Foam | Palm & Fingertips – Micro Dot Palm | □ Black | Engineered Yarn | ■ Blue | Coated Seamless Knit | 15 | XS - XXL |
| 44-3455 | A3 | 4542 | Nitrile Micro-Foam | Palm, Full Finger & Knuckle – Micro Dot Palm | □ Black | Engineered Yarn | ■ Blue | Coated Seamless Knit | 15 | XS - XXL |

LIGHT CUT HAZARDS – ABRASION RISK

COATED SEAMLESS KNIT GLOVES

LIGHT CUT HAZARDS ABRASION RISK

LIGHT to MEDIUM
CUT HAZARDS

HIGH
CUT HAZARDS

MEDIUM to HIGH
CUT HAZARDS

| STYLE NUMBER | ANSI | EN 388 |
|------------------------|------|--------|
| G-TEK® 36X® | | |
| 19-D350 | A2 | 4342 |
| 19-D324 | A2 | 4542 |
| 19-D318 | A2 | 3342 |
| G-TEK® POLYKOR® | | |
| 16-343LG | A2 | 4344 |
| 16-343OR | A2 | 4344 |
| 16-330 | A2 | 4342 |
| 16-334 | A2 | 4343 |
| 16-355 | A2 | 4343 |
| 16-323 | A2 | 4332 |
| 16-813 | A2 | 3343 |
| 16-D622 | A2 | 4342 |
| 16-318V | A2 | 4342 |
| 16-150 | A2 | 4342 |
| 16-530 | A2 | 4343 |
| 19-D650 | A2 | 4342 |
| 19-D655 | A2 | 4341 |

| STYLE NUMBER | ANSI | EN 388 |
|----------------------------|------|--------|
| G-TEK® KEV™ | | |
| 09-K1660 | A2 | 4343 |
| 09-K1400 | A2 | 2342 |
| 09-K1450 | A2 | 3221 |
| 09-K1250 | A2 | 4231 |
| ATG® MAXICUT® 3 | | |
| 18-570 | A2 | 4331 |
| 18-575 | A2 | 4331 |
| ATG® MAXIFLEX® CUT™ | | |
| 34-8443 | A2 | 4331 |
| 34-8453 | A2 | 4331 |
| 34-8743 | A2 | 4331 |
| 34-8743FY | A2 | 4331 |
| 34-8753 | A2 | 4331 |
| 34-1743 | A2 | 4331 |
| 34-6743 | A2 | 4331 |

LIGHT CUT HAZARDS



- Low to medium gauge, thicker liner means more fabric loft to absorb and resist abrasion
- Spun yarns loftier to mitigate abrasion effects to skin

CRH MATRIX™

LIGHT CUT HAZARDS – ABRASION RISK

COATED SEAMLESS KNIT GLOVES

ABRASION
RISK

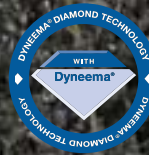

ANSI **A2** EN **3**
NITRILE FOAM COATING

G-TEK® 3GX®
19-D350

- High tactile sensitivity and dexterity
- Excellent dry grip and resistance to oils
- Better comfort against skin
- Dark liner and coating hides dirt
- Excellent durability

APPLICATIONS: *Handling Metal Parts, Assembly, Fastening, Industrial, Construction*



ANSI **A2** EN **5**
POLYURETHANE COATING

G-TEK® 3GX®
19-D324

- High tactile sensitivity and dexterity
- Good grip in dry, wet, and slightly oily conditions
- Excellent durability

APPLICATIONS: *Electronics and Metal Assembly, Small and Medium Sharp Parts Handling*

MAXIMUM DEXTERITY & COMFORT

ANSI **A2** EN **3**
POLYURETHANE COATING

G-TEK® 3GX®
19-D318

- Super thin cut resistant glove for the ultimate dexterity and tactile sensitivity
- Good grip in dry, wet, and slightly oily conditions
- Good durability

APPLICATIONS: *Small Parts Handling and Assembly, Packaging, Fastening, Wiring*

ULTRA THIN



DEPENDABLE CUT PROTECTION

LIGHT CUT HAZARDS

| STYLE NUMBER | ANSI | EN 388 | COATING | COATING COVERAGE | COATING COLOR | LINER MATERIAL | LINER COLOR | CONSTRUCTION | GAUGE | SIZES |
|----------------|------|--------|--------------|-------------------|---------------|----------------|-----------------|----------------------|-------|----------|
| 19-D350 | A2 | 4342 | Nitrile Foam | Palm & Fingertips | □ Gray | G-Tek® 3GX® | □ Salt & Pepper | Coated Seamless Knit | 13 | S - XL |
| 19-D324 | A2 | 4542 | Polyurethane | Palm & Fingertips | □ Black | G-Tek® 3GX® | ■ White | Coated Seamless Knit | 13 | XS - XXL |
| 19-D318 | A2 | 3342 | Polyurethane | Palm & Fingertips | □ Black | G-Tek® 3GX® | ■ Blue | Coated Seamless Knit | 18 | XS - XXL |

LIGHT CUT HAZARDS – ABRASION RISK

COATED SEAMLESS KNIT GLOVES



HI-VISIBILITY



**G-TEK® POLYKOR®
16-343LG**

- High tactile sensitivity and dexterity
- Excellent dry grip and resistance to oils
- Better grip in wet conditions
- Better comfort against skin
- High puncture resistance
- Excellent durability

APPLICATIONS: *Electronics, Sheet Metal Handling, Parts Assembly, Small Sharp Parts Handling, Construction, General Maintenance*



DOUBLE-DIPPED COATING



**G-TEK® POLYKOR®
16-330**

- High tactile sensitivity and dexterity
- Excellent dry grip and resistance to oils
- Better grip in wet conditions
- Better comfort against skin
- Excellent durability
- Double-dipped coating for added wear protection

APPLICATIONS: *Electronics, Sheet Metal Handling, Parts Assembly, Small Sharp Parts Handling, Construction, General Maintenance*



**G-TEK® POLYKOR®
16-334**

- High tactile sensitivity and dexterity
- Excellent dry grip and resistance to oils
- Better comfort against skin
- Good puncture resistance
- Excellent durability

APPLICATIONS: *Electronics, Sheet Metal Handling, Parts Assembly, Small Sharp Parts Handling, Construction, General Maintenance*



CONFIDENCE TO DO THE JOB



ENHANCED PROTECTION



**G-TEK® POLYKOR®
16-355**

- High tactile sensitivity and dexterity
- Excellent dry grip and resistance to oils
- Better comfort against skin
- Greater coating coverage for enhanced protection
- Good puncture resistance
- Excellent durability

APPLICATIONS: *Electronics, Sheet Metal Handling, Parts Assembly, Small Sharp Parts Handling, Construction, General Maintenance*



HI-VISIBILITY



**G-TEK® POLYKOR®
16-323**

- High tactile sensitivity and dexterity
- Good dry grip and resistance to oils
- Better comfort against skin
- High abrasion resistance
- Reinforced thumb crotch provides added durability

APPLICATIONS: *Electronics, Sheet Metal Handling, Parts Assembly, Small Sharp Parts Handling, Construction, General Maintenance*

LIGHT CUT HAZARDS

| STYLE NUMBER | ANSI | EN 388 | COATING | COATING COVERAGE | COATING COLOR | LINER MATERIAL | LINER COLOR | CONSTRUCTION | GAUGE | SIZES |
|-----------------|------|--------|----------------------|-----------------------------|---------------|-----------------|---------------|----------------------|-------|-----------|
| 16-343LG | A2 | 4344 | Nitrile MicroSurface | Palm & Fingertips | Black | G-Tek® PolyKor® | Hi-Vis Lime | Coated Seamless Knit | 13 | XS - XXL |
| 16-343OR | A2 | 4344 | Nitrile MicroSurface | Palm & Fingertips | Black | G-Tek® PolyKor® | Hi-Vis Orange | Coated Seamless Knit | 13 | XS - XXL |
| 16-330 | A2 | 4342 | Nitrile MicroSurface | Palm & Fingertips | Black | G-Tek® PolyKor® | Blue | Coated Seamless Knit | 13 | XS - XXL |
| 16-334 | A2 | 4343 | Nitrile Foam | Palm & Fingertips | Black | G-Tek® PolyKor® | Salt & Pepper | Coated Seamless Knit | 13 | XS - XXL |
| 16-355 | A2 | 4343 | Nitrile Foam | Palm, Full Finger & Knuckle | Black | G-Tek® PolyKor® | Salt & Pepper | Coated Seamless Knit | 13 | XS - XXL |
| 16-323 | A2 | 4332 | Nitrile Foam | Palm & Fingertips | Gray | G-Tek® PolyKor® | Hi-Vis Lime | Coated Seamless Knit | 13 | XS - XXXL |
| 16-813 | A2 | 3343 | Latex Crinkle | Palm & Fingertips | Yellow | G-Tek® PolyKor® | White | Coated Seamless Knit | 13 | XS - XXL |



**G-TEK® POLYKOR®
16-813**

- High tactile sensitivity and dexterity
- Excellent grip in dry and wet, non-oily conditions
- Better comfort against skin
- Good puncture resistance
- Good durability

APPLICATIONS: *Ceramics, Glass Cutting, Metal Handling, General Maintenance*

LIGHT CUT HAZARDS – ABRASION RISK

COATED SEAMLESS KNIT GLOVES



G-Tek[®]
PolyKor[®]

PROVEN & TRUSTED[®] CUT PROTECTION

LIGHT CUT HAZARDS – ABRASION RISK

COATED SEAMLESS KNIT GLOVES



**G-TEK® POLYKOR®
16-D622**

- High tactile sensitivity and dexterity
- Good grip in dry, wet, and slightly oily conditions
- Good puncture resistance

APPLICATIONS: *Electronics, Sheet Metal Handling, Parts Assembly, Small Sharp Parts Handling, Construction, General Maintenance*



SUPER THIN



**G-TEK® POLYKOR®
16-318V**

- Super thin cut resistant glove for the ultimate dexterity and tactile sensitivity
- Good grip in dry, wet and slightly oily conditions
- Good durability

APPLICATIONS: *Finishing and Inspection, Small Parts Handling, Maintenance*



**G-TEK® POLYKOR®
16-150**

- High tactile sensitivity and dexterity
- Good grip in dry, wet, and slightly oily conditions
- Dark liner and coating hides dirt
- Excellent durability

APPLICATIONS: *Electronics, Sheet Metal Handling, Parts Assembly, Small Sharp Parts Handling, Construction, General Maintenance*



**G-TEK® POLYKOR®
16-530**

- High tactile sensitivity and dexterity
- Good grip in dry, wet, and slightly oily conditions
- Dark liner and coating hides dirt
- Good puncture resistance
- Excellent durability

APPLICATIONS: *Electronics, Sheet Metal Handling, Parts Assembly, Small Sharp Parts Handling, Construction, General Maintenance*

HIDES DIRT



**G-TEK® POLYKOR®
19-D650**

- High tactile sensitivity and dexterity
- Good grip in dry, wet, and slightly oily conditions
- Dark liner and coating hides dirt
- Spun fiber enhances comfort
- Excellent durability

APPLICATIONS: *Electronics, Sheet Metal Handling, Parts Assembly, Small Sharp Parts Handling, Construction, General Maintenance*



**G-TEK® POLYKOR®
19-D655**

- High tactile sensitivity and dexterity
- Good grip in dry, wet, and slightly oily conditions
- Dark liner and coating hides dirt
- Greater coating coverage for enhanced protection
- Spun fiber enhances comfort
- Excellent durability

APPLICATIONS: *Electronics, Sheet Metal Handling, Parts Assembly, Small Sharp Parts Handling, Construction, General Maintenance*

ENHANCED PROTECTION

LIGHT CUT HAZARDS

| STYLE NUMBER | ANSI | EN 388 | COATING | COATING COVERAGE | COATING COLOR | LINER MATERIAL | LINER COLOR | CONSTRUCTION | GAUGE | SIZES |
|----------------|------|--------|--------------|-----------------------------|---------------|-----------------|-----------------|----------------------|-------|-----------|
| 16-D622 | A2 | 4342 | Polyurethane | Palm & Fingertips | ■ Gray | G-Tek® PolyKor® | ■ White | Coated Seamless Knit | 13 | XS - XXL |
| 16-318V | A2 | 4342 | Polyurethane | Palm | ■ Blue | G-Tek® PolyKor® | ■ Blue | Coated Seamless Knit | 18 | XS - XXL |
| 16-150 | A2 | 4342 | Polyurethane | Palm & Fingertips | □ Black | G-Tek® PolyKor® | □ Salt & Pepper | Coated Seamless Knit | 13 | XS - XXXL |
| 16-530 | A2 | 4343 | Polyurethane | Palm & Fingertips | ■ Gray | G-Tek® PolyKor® | □ Salt & Pepper | Coated Seamless Knit | 13 | XS - XXL |
| 19-D650 | A2 | 4342 | Polyurethane | Palm & Fingertips | ■ Gray | G-Tek® PolyKor® | ■ Gray | Coated Seamless Knit | 13 | S - XXL |
| 19-D655 | A2 | 4341 | Polyurethane | Palm, Full Finger & Knuckle | □ Black | G-Tek® PolyKor® | □ Salt & Pepper | Coated Seamless Knit | 13 | S - XL |

LIGHT CUT HAZARDS – ABRASION RISK

COATED SEAMLESS KNIT GLOVES



HIGH STRENGTH & THERMAL STABILITY



Kevlar
DARE < BIGGER™



**G-TEK® KEV™
09-K1660**

- Higher dexterity
- Excellent dry grip and resistance to oils
- Better grip in wet conditions
- Excellent durability

APPLICATIONS: *Ceramics, Glass Cutting,
Metal Handling, General Maintenance*



09-K1400

- Excellent dry grip conditions and resistance to oils

APPLICATIONS: *Ceramics, Glass Cutting,
Metal Handling, General Maintenance*

100% KEVLAR® SHELL



09-K1450

- Higher dexterity
- Excellent dry grip and resistance to oils
- Good durability

APPLICATIONS: *Ceramics, Glass Cutting,
Metal Handling, General Maintenance*

EXCELLENT DRY GRIP



**G-TEK® KEV™
09-K1250**

- Higher dexterity
- Good grip in wet and dry conditions with light oils
- Excellent durability

APPLICATIONS: *Electronics, Parts
Assembly, Small Sharp Parts Handling,
Construction, General Maintenance*

LIGHT CUT HAZARDS

| STYLE NUMBER | ANSI | EN 388 | COATING | COATING COVERAGE | COATING COLOR | LINER MATERIAL | LINER COLOR | CONSTRUCTION | GAUGE | SIZES |
|-----------------|------|--------|----------------------|-------------------|---------------|-----------------|-------------|----------------------|-------|-----------|
| 09-K1660 | A2 | 4343 | Nitrile MicroSurface | Palm & Fingertips | ☐ Black | G-Tek® KEV™ | ■ Yellow | Coated Seamless Knit | 13 | S - XXL |
| 09-K1400 | A2 | 2342 | Nitrile | Palm & Fingertips | ☐ Black | DuPont™ Kevlar® | ■ Yellow | Coated Seamless Knit | 10 | XS - XL |
| 09-K1450 | A2 | 3221 | Nitrile | Palm & Fingertips | ☐ Black | DuPont™ Kevlar® | ■ Yellow | Coated Seamless Knit | 15 | XS - XXXL |
| 09-K1250 | A2 | 4231 | Polyurethane | Palm & Fingertips | ■ Gray | G-Tek® KEV™ | ■ Yellow | Coated Seamless Knit | 13 | XS - XXL |

LIGHT CUT HAZARDS – ABRASION RISK

COATED SEAMLESS KNIT GLOVES



CUT PROTECTION FOR TOUGH JOBS



▲ 18-570

▲ 18-575



◀ MAXICUT® 3

- Good dexterity and tactility
- Patented micro-foam nitrile coating offers 360° breathability
- Excellent dry grip and compatibility with light oils
- Thumb reinforcement for durability
- Good puncture resistance
- Excellent durability

APPLICATIONS: *Electronics, Metal Assembly, Small Sharp Parts Handling, Maintenance, Repair*

LIGHT CUT HAZARDS

| STYLE NUMBER | ANSI | EN 388 | COATING | COATING COVERAGE | COATING COLOR | LINER MATERIAL | LINER COLOR | CONSTRUCTION | GAUGE | SIZES |
|---------------|------|--------|--------------------|-----------------------------|---------------|-----------------|-------------|----------------------|-------|-----------|
| 18-570 | A2 | 4331 | Nitrile Micro-Foam | Palm & Fingertips | ■ Gray | Engineered Yarn | ■ Green | Coated Seamless Knit | 15 | XS - XXXL |
| 18-575 | A2 | 4331 | Nitrile Micro-Foam | Palm, Full Finger & Knuckle | ■ Gray | Engineered Yarn | ■ Green | Coated Seamless Knit | 15 | XS - XXL |

LIGHT CUT HAZARDS – ABRASION RISK

COATED SEAMLESS KNIT GLOVES

TRIED & TRUSTED



▲ 34-8743

MICRO DOT PALM

▲ 34-8443



DUPONT™ KEVLAR®

▲ 34-1743

DYNEEMA® DIAMOND TECHNOLOGY

▲ 34-6743



MAXIFLEX® CUT™

- High dexterity and tactility
- Patented Micro-Foam nitrile coating offers 360° breathability for increased comfort
- Micro-cup finish provides excellent dry grip and compatibility with light oils

- Made with component materials that comply with federal regulations for food contact 21 CFR, 170-199

APPLICATIONS: *Electronics and Metal Assembly, Small Sharp Parts Handling, Maintenance, Repair Operations, Logistics, Warehousing, Construction*

#1 INDUSTRIAL GLOVE WITH CUT PROTECTION

LIGHT CUT HAZARDS

| STYLE NUMBER | ANSI | EN 388 | COATING | COATING COVERAGE | COATING COLOR | LINER MATERIAL | LINER COLOR | CONSTRUCTION | GAUGE | SIZES |
|------------------|------|--------|--------------------|--|-----------------|-----------------------------|-----------------|----------------------|-------|-----------|
| 34-8443 | A2 | 4331 | Nitrile Micro-Foam | Palm & Fingertips - Micro Dot Palm | □ Black | Engineered Yarn | ■ Green | Coated Seamless Knit | 15 | XS - XXL |
| 34-8453 | A2 | 4331 | Nitrile Micro-Foam | Palm, Full Finger & Knuckle - Micro Dot Palm | □ Black | Engineered Yarn | ■ Green | Coated Seamless Knit | 15 | XS - XXL |
| 34-8743 | A2 | 4331 | Nitrile Micro-Foam | Palm & Fingertips | □ Black | Engineered Yarn | ■ Green | Coated Seamless Knit | 15 | XS - XXXL |
| 34-8743FY | A2 | 4331 | Nitrile Micro-Foam | Palm & Fingertips | ■ Hi-Vis Yellow | Engineered Yarn | ■ Hi-Vis Yellow | Coated Seamless Knit | 15 | XS - XXXL |
| 34-8753 | A2 | 4331 | Nitrile Micro-Foam | Palm, Full Finger & Knuckle | □ Black | Engineered Yarn | ■ Green | Coated Seamless Knit | 15 | XS - XXL |
| 34-1743 | A2 | 4331 | Nitrile Micro-Foam | Palm & Fingertips | □ Black | DuPont™ Kevlar® | ■ Hi-Vis Yellow | Coated Seamless Knit | 15 | S - XXL |
| 34-6743 | A2 | 4331 | Nitrile Micro-Foam | Palm & Fingertips | □ Black | Dyneema® Diamond Technology | ■ Powder Blue | Coated Seamless Knit | 15 | S - XXL |



LIGHT TO MEDIUM CUT HAZARDS – ABRASION, LACERATION & CONTUSION RISK

COATED SEAMLESS KNIT GLOVES

| STYLE NUMBER | ANSI | EN 388 |
|------------------------|------|--------|
| MAXIMUM SAFETY® | | |
| 120-5150 | A3 | 4544 |
| 120-5130 | A2 | 4344 |

LIGHT to MEDIUM CUT HAZARDS

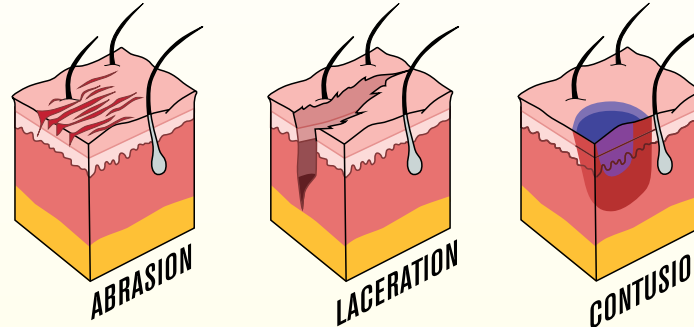

- Low gauge, thicker liner means more fabric loft to absorb and resist abrasion
- Spun yarns loftier to mitigate abrasion effects to skin
- TPR* impact protection to help protect against impact injuries

CRH MATRIX™

HIGH
CUT HAZARDS

LIGHT
CUT HAZARDS

MEDIUM to HIGH
CUT HAZARDS

LIGHT TO MEDIUM CUT HAZARDS ABRASION, LACERATION & CONTUSION RISK

*Thermoplastic Rubber

LIGHT TO MEDIUM CUT HAZARDS – ABRASION, LACERATION & CONTUSION RISK

COATED SEAMLESS KNIT GLOVES

ABRASION
LACERATION
CONTUSION
RISK



▲ 120-5150



▲ 120-5130



MAXIMUM SAFETY® TUFFMAX5™ AND TUFFMAX3™

- Lightweight HPPE knit liner provides excellent dexterity and tactile sensitivity
- Thermoplastic rubber (TPR) guards for pinch point protection
- MicroSurface nitrile for enhanced grip in wet, dry and oily applications
- Dorsal protection against impact to the back of the hand
- Excellent puncture resistance
- Extended cuff for additional protection

APPLICATIONS: *Petrochemical, Heavy/Light Construction, Demolition, Manufacturing, Mining, Rigging, Fabrication*



MAXIMUM PROTECTION

LIGHT TO MEDIUM CUT HAZARDS

| STYLE NUMBER | ANSI | EN 388 | COATING | COATING COVERAGE | COATING COLOR | LINER MATERIAL | LINER COLOR | CONSTRUCTION | GAUGE | SIZES |
|-----------------|------|--------|----------------------|-------------------|--------------------------------|----------------|---|----------------------|-------|---------|
| 120-5150 | A3 | 4544 | Nitrile MicroSurface | Palm & Fingertips | <input type="checkbox"/> Black | HPPE | <input checked="" type="checkbox"/> Hi-Vis Orange | Coated Seamless Knit | 13 | M - XXL |
| 120-5130 | A2 | 4344 | Nitrile MicroSurface | Palm & Fingertips | <input type="checkbox"/> Black | HPPE | <input checked="" type="checkbox"/> Hi-Vis Green | Coated Seamless Knit | 13 | M - XXL |



Made in the U.S.A., Kut Gard® seamless knit gloves are designed to provide the highest possible cut protection and because they comply with both the US and Canadian standards for food contact, Kut Gard® gloves can be used for operations where direct, indirect, and incidental contact with food may occur.

**KUT GARD®
WITH DYNEEMA®**

Dyneema® is 15 times stronger than steel on a weight for weight basis! It's a High Performance Polyethylene (HPPE) fiber made from Ultra-High Molecular Weight Polyethylene (UHMWPE). Dyneema® fiber is much thinner and more flexible than traditional materials, such as leather and cotton, while offering higher protection.

**KUT GARD®
PolyKor®**

Products constructed with PolyKor® engineered yarn are suitable for protection against mechanical hazards in the toughest environments. PolyKor® products can be designed for different protection levels, up to the highest levels, while maintaining an unprecedented level of comfort.

**KUT GARD®
MADE WITH
KEVLAR®**

Kevlar® is light, comfortable and provides enduring protection against heat, cuts, lacerations and abrasions. Protective gloves and sleeves bearing this brand name provide assurance of compliance to strict performance and quality standards, and are produced only by Kevlar® licensed manufacturers.

**KUT GARD®
ACP™**

Proprietary ACP™ Technology raises the standards for performance knit products offering an increase in overall performance and value compared to traditional Aramid products. ACP™ provides excellent abrasion and cut resistance for lower cost per use. ACP™ Technology gloves and sleeves are 100% silicone free.



HIGH CUT HAZARDS – INCISION RISK

SEAMLESS KNIT GLOVES

INCISION
RISK



HIGH CUT HIGH-VISIBILITY



22-760



22-760OR



22-760BG



22-760GRN



22-760G



22-760NP



ANSI
A7

◀ **KUT GARD®
22-760BB**

- Excellent cut protection
- Made with component materials that comply with federal regulations for food contact 21 CFR 170-199
- Ambidextrous

APPLICATIONS: *Food Service, Food Processing, Glass and Metal Handling*



SILAGRIP

ANSI
A5

◀ **KUT GARD®
22-751**

- Excellent cut protection
- Made with component materials that comply with federal regulations for food contact 21 CFR 170-199
- Silagrip coating provides superior wet and dry grip

APPLICATIONS: *Food Service, Food Processing, Pulp and Paper Processing, Plastic Molding, Glass and Metal Handling*



ANSI
A4

◀ **KUT GARD®
08-KA740PD**

- Excellent cut resistance
- Light heat protection
- Dotted palm for enhanced grip and abrasion resistance

APPLICATIONS: *Sheet Metal Fabrication, Recycling, Metal Fabrication, Pulp and Paper Processing*



PROTECT AGAINST INCISION

HIGH CUT HAZARDS

| STYLE NUMBER | ANSI | 21 CFR | MATERIAL | COLOR | CONSTRUCTION | GAUGE | WEIGHT | COATING | COATING COVERAGE | SIZES |
|--------------------|------|--------|-----------------------------|----------------|---|-------|--------|--------------------|------------------|----------|
| 22-760 | A7 | Yes | Kut Gard® with Dyneema® | ■ White | Seamless Knit | 10 | Medium | --- | --- | XS - XL |
| 22-760BB | A7 | Yes | Kut Gard® with Dyneema® | ■ Bright Blue | Seamless Knit | 10 | Medium | --- | --- | XS - XXL |
| 22-760BG | A7 | Yes | Kut Gard® with Dyneema® | ■ Bright Green | Seamless Knit | 10 | Medium | --- | --- | XS - XXL |
| 22-760G | A7 | Yes | Kut Gard® with Dyneema® | ■ Gray | Seamless Knit | 10 | Medium | --- | --- | XS - XL |
| 22-760GRN | A7 | Yes | Kut Gard® with Dyneema® | ■ Dark Green | Seamless Knit | 10 | Medium | --- | --- | XS - XXL |
| 22-760NP | A7 | Yes | Kut Gard® with Dyneema® | ■ Neon Pink | Seamless Knit | 10 | Medium | --- | --- | XS - XXL |
| 22-760OR | A7 | Yes | Kut Gard® with Dyneema® | ■ Orange | Seamless Knit | 10 | Medium | --- | --- | XS - XXL |
| 18-SD385 | A6 | Yes | Kut Gard® with Dyneema® | ■ Gray | Seamless Knit | 7 | Medium | Blue PVC Dense Dot | Double-Sided | XS - XL |
| 22-770 | A6 | Yes | Kut Gard® with Dyneema® | ■ White | Seamless Knit | 7 | Heavy | --- | --- | XS - XL |
| 22-750 | A5 | Yes | Kut Gard® with Dyneema® | ■ White | Seamless Knit | 13 | Light | --- | --- | XS - XL |
| 22-751 | A5 | Yes | Kut Gard® with Dyneema® | ■ White | Seamless Knit, Hand Specific | 13 | Light | Silagrip Palm | Single-Sided | XS - XL |
| 22-600 | A9 | Yes | Kut Gard® PolyKor® | ■ White | Seamless Knit | 7 | Heavy | --- | --- | XS - XL |
| 22-600BK | A9 | Yes | Kut Gard® PolyKor® | ■ Black | Seamless Knit | 7 | Heavy | --- | --- | S - L |
| 22-601 | A9 | Yes | Kut Gard® PolyKor® | ■ White | Seamless Knit, Hand Specific | 7 | Heavy | Silagrip Palm | Single-Sided | XS - XL |
| 22-615 | A9 | Yes | Kut Gard® PolyKor® | ■ White | Seamless Knit, Half-Finger, Hand Specific | 7 | Heavy | Silagrip Palm | Single-Sided | XS - XL |
| 22-650 | A7 | Yes | Kut Gard® PolyKor® | ■ Blue | Seamless Knit | 7 | Heavy | --- | --- | XS - XL |
| 22-900 | A7 | Yes | Kut Gard® PolyKor® | ■ Gray | Seamless Knit | 7 | Medium | --- | --- | XS - XL |
| 22-720 | A6 | Yes | Kut Gard® PolyKor® | ■ White | Seamless Knit | 10 | Medium | --- | --- | XS - XL |
| 07-K390 | A6 | No | Kut Gard® made with Kevlar® | ■ Yellow | Seamless Knit | 7 | Heavy | --- | --- | S - XL |
| 08-K385 | A6 | No | Kut Gard® made with Kevlar® | ■ Yellow | Seamless Knit | 7 | Heavy | Blue PVC Dot | Double-Sided | L |
| 07-KA720 | A6 | No | Kut Gard® ACP™ | ■ Green | Seamless Knit | 7 | Medium | --- | --- | S - XL |
| 08-KA720PD | A6 | No | Kut Gard® ACP™ | ■ Green | Seamless Knit | 7 | Medium | Blue PVC Dot | Single-Sided | S - XL |
| 08-KA720PDD | A6 | No | Kut Gard® ACP™ | ■ Green | Seamless Knit | 7 | Medium | Blue PVC Dense Dot | Double-Sided | S - XL |
| 08-KA728PD | A6 | No | Kut Gard® ACP™ | ■ Green | Seamless Knit, Extended Cuff | 7 | Medium | Blue PVC Dot | Single-Sided | S - XL |
| 08-KA728PDD | A6 | No | Kut Gard® ACP™ | ■ Green | Seamless Knit, Extended Cuff | 7 | Medium | Blue PVC Dense Dot | Double-Sided | S - XL |
| 07-KA730 | A5 | No | Kut Gard® ACP™ | ■ Green | Seamless Knit | 7 | Medium | --- | --- | S - XL |
| 08-KA700PD | A5 | No | Kut Gard® ACP™ | ■ Green | Seamless Knit | 7 | Heavy | Blue PVC Dot | Single-Sided | S - XL |
| 08-KA700PDD | A5 | No | Kut Gard® ACP™ | ■ Green | Seamless Knit | 7 | Heavy | Blue PVC Dense Dot | Double-Sided | S - XL |

MEDIUM TO HIGH CUT HAZARDS - LACERATION & INCISION RISK

SEAMLESS KNIT GLOVES

LACERATION
INCISION
RISK



MEDIUM TO HIGH
CUT HAZARDS

MEDIUM TO HIGH CUT HAZARDS – LACERATION & INCISION RISK

SEAMLESS KNIT GLOVES



**KUT GARD®
14-PK700**

- Excellent cut resistance to protect against minor cuts and scrapes
- Exceptional comfort and fit
- Superior abrasion and fatigue resistance
- 100% silicone free

APPLICATIONS: *Automotive Manufacturing, Metal Fabrication, Assembly, Plastic Molding, Glass Handling, Food Processing, And Metal Stamping*



**KUT GARD®
14-ASP700PDD**

- Excellent cut resistance to protect against minor cuts and scrapes
- Exceptional comfort and fit
- Double-sided PVC dots provided enhanced grip and extra cut and abrasion resistance
- 100% silicone free

APPLICATIONS: *Automotive Manufacturing, Metal Fabrication, Assembly, Plastic Molding, Glass Handling, Food Processing, And Metal Stamping*

DOUBLE-SIDED PVC DOT GRIP



**KUT GARD®
07-KA710**

- Excellent cut resistance
- Light heat protection
- Ambidextrous
- Heavier gauge for increased durability

APPLICATIONS: *Sheet Metal Fabrication, Recycling, Metal Fabrication, Pulp and Paper Processing*



HEAVY DUTY PERFORMANCE

MEDIUM TO HIGH CUT HAZARDS

| STYLE NUMBER | ANSI | 21 CFR | MATERIAL | COLOR | CONSTRUCTION | GAUGE | WEIGHT | COATING | COATING COVERAGE | SIZES |
|------------------------------|------|--------|-------------------------------|-------------------------|---------------|-------|---------|--------------------|------------------|----------|
| 14-PK700 | A4 | Yes | Kut Gard® PolyKor® | ☐ Black / White | Seamless Knit | 7 | Heavy | --- | --- | XS - XL |
| 17-DA700 | A4 | Yes | Kut Gard® PolyKor® | ☐ Gray | Seamless Knit | 7 | Medium | --- | --- | S - XL |
| 17-DA720 | A4 | Yes | Kut Gard® PolyKor® | ☐ Gray | Seamless Knit | 13 | Light | --- | --- | S - XL |
| 22-730 | A4 | Yes | Kut Gard® PolyKor® | ■ White | Seamless Knit | 13 | Light | --- | --- | XS - XL |
| 14-ASP700 | A4 | Yes | Antimicrobial Engineered Yarn | ☐ Black / White Heather | Seamless Knit | 10 | Medium | Green PVC Dot | Single-Sided | XXS - XL |
| 14-ASP700PDD | A4 | Yes | Antimicrobial Engineered Yarn | ☐ Black / White Heather | Seamless Knit | 10 | Medium | PVC Dense Dot | Double-Sided | XXS - XL |
| 07-KA710 | A4 | No | Kut Gard® ACP™ | ■ Green | Seamless Knit | 10 | Medium | --- | --- | S - XL |
| 09-K300LP | A4 | No | Kut Gard® made with Kevlar® | ■ Yellow | Seamless Knit | 7 | Medium | Leather Palm | Single-Sided | S - XL |
| 07-KA700 | A4 | No | Kut Gard® ACP™ | ■ Green | Seamless Knit | 7 | Heavy | --- | --- | S - XL |
| 08-KA740RT | A4 | No | Kut Gard® ACP™ | ■ Green | Seamless Knit | 7 | Economy | Blue PVC Dot | Single-Sided | S - XL |
| 08-KA740PD | A4 | No | Kut Gard® ACP™ | ■ Green | Seamless Knit | 7 | Economy | Blue PVC Dot | Single-Sided | S - XL |
| 08-KA740PDD | A4 | No | Kut Gard® ACP™ | ■ Green | Seamless Knit | 7 | Economy | Blue PVC Dense Dot | Double-Sided | S - XL |
| 07-KA740 | A4 | No | Kut Gard® ACP™ | ■ Green | Seamless Knit | 7 | Economy | --- | --- | S - XL |
| 08-KA750PD | A4 | No | Kut Gard® ACP™ | ■ Green | Seamless Knit | 13 | Light | Blue PVC Dot | Single-Sided | S - XL |
| 08-KA750PDD | A4 | No | Kut Gard® ACP™ | ■ Green | Seamless Knit | 13 | Light | Blue PVC Dense Dot | Double-Sided | S - XL |

LIGHT TO MEDIUM CUT HAZARDS – ABRASION, LACERATION & INCISION RISK

SEAMLESS KNIT GLOVES

ABRASION
LACERATION
INCISION
RISK



LIGHT TO MEDIUM
CUT HAZARDS

LIGHT TO MEDIUM CUT HAZARDS – ABRASION, LACERATION & INCISION RISK

SEAMLESS KNIT GLOVES



KUT GARD® 17-D350

- Good cut protection
- Made with component materials that comply with federal regulations for food contact 21 CFR 170-199
- Breathable and comfortable
- Heavyweight for added durability
- Ambidextrous

APPLICATIONS: *Food Processing, Use As A Glove Liner*



KUT GARD® 07-K350

- Good cut protection
- Light heat protection
- Ambidextrous

APPLICATIONS: *Glass Handling, Canning, Bottling, Sheet Metal Handling, Recycling, Automotive Plants*



KUT GARD® 07-KA744

- Good cut resistance
- Light heat protection
- Ambidextrous
- Heavier gauge for increased durability

APPLICATIONS: *Sheet Metal Fabrication, Recycling, Metal Fabrication, Pulp and Paper Processing*



RIGHT GLOVE FOR THE RIGHT JOB

LIGHT TO MEDIUM CUT HAZARDS

| STYLE NUMBER | ANSI | 21 CFR | MATERIAL | COLOR | CONSTRUCTION | GAUGE | WEIGHT | COATING | COATING COVERAGE | SIZES |
|--------------------|------|--------|-----------------------------|----------|------------------------------|-------|---------|--------------------|------------------|----------|
| 17-D350 | A3 | Yes | Kut Gard® with Dyneema® | ■ White | Seamless Knit | 7 | Heavy | --- | --- | XS - XL |
| 17-DL300 | A3 | Yes | Kut Gard® with Dyneema® | ■ White | Seamless Knit | 7 | Medium | --- | --- | XS - XXL |
| 17-SD350 | A3 | Yes | Kut Gard® with Dyneema® | ■ White | Seamless Knit | 7 | Heavy | --- | --- | XS - XL |
| 07-K350 | A3 | No | Kut Gard® made with Kevlar® | ■ Yellow | Seamless Knit | 7 | Heavy | --- | --- | XS - XXL |
| 08-K350PDD | A3 | No | Kut Gard® made with Kevlar® | ■ Yellow | Seamless Knit | 7 | Heavy | Blue PVC Dense Dot | Double-Sided | S - XL |
| 08-K412PDD | A3 | No | Kut Gard® made with Kevlar® | ■ Yellow | Seamless Knit, Extended Cuff | 7 | Heavy | Blue PVC Dense Dot | Double-Sided | S - XL |
| 07-KA744 | A3 | No | Kut Gard® ACP™ | ■ Green | Seamless Knit | 7 | Economy | --- | --- | S - XL |
| 08-KA744PD | A3 | No | Kut Gard® ACP™ | ■ Green | Seamless Knit | 7 | Economy | Blue PVC Dot | Single-Sided | S - XL |
| 08-KA744PDD | A3 | No | Kut Gard® ACP™ | ■ Green | Seamless Knit | 7 | Economy | Blue PVC Dense Dot | Double-Sided | S - XL |

LIGHT CUT HAZARDS – ABRASION RISK

SEAMLESS KNIT GLOVES

ABRASION
RISK



LIGHT CUT HAZARDS

| STYLE NUMBER | ANSI | 21 CFR | MATERIAL | COLOR | CONSTRUCTION | GAUGE | WEIGHT | COATING | COATING COVERAGE | SIZES |
|----------------------------|------|--------|---|-----------|--------------------------------|-------|--------|----------------------|------------------|----------|
| 17-D200 | A2 | Yes | Kut Gard® with Dyneema® | ■ White | Seamless Knit | 13 | Light | --- | --- | XS - XL |
| 17-DL200 | A2 | Yes | Kut Gard® with Dyneema® | ■ White | Seamless Knit | 13 | Light | --- | --- | XS - XL |
| 17-SD200 | A2 | Yes | Kut Gard® with Dyneema® | ■ White | Seamless Knit | 13 | Light | --- | --- | XS - XL |
| 17-D300 | A2 | Yes | Kut Gard® with Dyneema® | ■ White | Seamless Knit | 7 | Medium | --- | --- | XS - XL |
| 17-SD300 | A2 | Yes | Kut Gard® with Dyneema® | ■ White | Seamless Knit | 7 | Medium | --- | --- | XS - XL |
| 07-K200 | A2 | No | Kut Gard® made with Kevlar® | ■ Yellow | Seamless Knit | 13 | Light | --- | --- | XS - XXL |
| 07-K259 | A2 | No | Kut Gard® made with Kevlar® | ■ Yellow | Seamless Knit, Half-Finger | 13 | Medium | --- | --- | XS - XXL |
| 08-K259PDD | A2 | No | Kut Gard® made with Kevlar® | ■ Yellow | Seamless Knit, Half-Finger | 7 | Medium | Blue PVC Dense Dot | Double-Sided | S - XL |
| 07-K300 | A2 | No | Kut Gard® made with Kevlar® | ■ Yellow | Seamless Knit | 7 | Medium | --- | --- | XS - XXL |
| 08-K300PD | A2 | No | Kut Gard® made with Kevlar® | ■ Yellow | Seamless Knit | 7 | Medium | Blue PVC Dot | Single-Sided | XS - XL |
| 08-K300PDD | A2 | No | Kut Gard® made with Kevlar® | ■ Yellow | Seamless Knit | 7 | Medium | Blue PVC Dense Dot | Double-Sided | XS - XL |
| 08-K300PS | A2 | No | Kut Gard® made with Kevlar® | ■ Yellow | Seamless Knit | 7 | Medium | Brown PVC Tiger Paw | Single-Sided | S - XL |
| 08-K300XC | A2 | No | Kut Gard® made with Kevlar® | ■ Yellow | Seamless Knit | 7 | Medium | Blue PVC Criss-Cross | Single-Sided | M - XL |
| 08-K312 | A2 | No | Kut Gard® made with Kevlar® | ■ Yellow | Seamless Knit, Extended Cuff | 7 | Medium | Blue PVC Dense Dot | Double-Sided | S & L |
| 08-K200PD | A2 | No | Kut Gard® made with Kevlar® | ■ Yellow | Seamless Knit | 13 | Light | Blue PVC Dot | Single-Sided | S - XL |
| 08-K200PDD | A2 | No | DuPont™ Kevlar® | ■ Yellow | Seamless Knit | 13 | Light | Blue PVC Dense Dot | Double-Sided | S - XL |
| 08-K252 | A2 | No | Kut Gard® made with Kevlar® | ■ Yellow | Seamless Knit | 7 | Medium | Blue PVC Dense Dot | Double-Sided | S - XL |
| 07-K320 | A1 | No | Kut Gard® made with Kevlar® | ■ Yellow | Seamless Knit | 7 | Medium | --- | --- | S - XL |
| 09-K3700 | A2 | No | Top Grain Goatskin | ■ Tan | Kevlar® Lined - Straight Thumb | --- | Light | --- | --- | S - XXXL |
| 09-K3720 | A4 | No | Top Grain Goatskin, Split Cowhide Back | ■ Natural | Kevlar® Lined - Keystone Thumb | --- | Medium | --- | --- | S - XXL |
| 09-K3750 | A2 | No | Maximum Safety®, AR/FR Top Grain Goatskin Leather | ■ Natural | Kevlar® Lined - Straight Thumb | --- | Medium | --- | --- | S - XXXL |

LIGHT CUT HAZARDS



NEW PRODUCTS

COATED SEAMLESS KNIT GLOVES



G-Tek

NEW

GENERAL PURPOSE FROM PIP



NEOFOAM™
COATING

NEWEST INNOVATION IN
THE G-TEK® 34 SERIES OF
GENERAL PURPOSE GLOVES

The [34-600](#) features our proprietary Neofoam™ coating technology with superior grip in dry, wet and oily surface conditions. Flexible to -4°F and resists up to 12,000 cycles on abrasion test, this breathable highly dexterous glove is the new “go-to” glove for all jobs.



LATEX
MICROSURFACE
COATING

100% WATERPROOF

For jobs that require a little more palm and finger coverage, but still require grip and dexterity, there's the [55-1600](#). With a double-dipped latex MicroSurface grip, the coating is completely waterproof and extremely abrasion resistant. But, workers can still grab objects with ease while enjoying the all-day comfort of the nylon shell.



NITRILE
FOAM GRIP
COATING

COLD GLOVES AND WORK
GLOVES COMBINED INTO ONE

The new [41-1415](#) has the double-dipped, full coverage coating needed to provide workers with protection and a superior grip in wet dry and oily conditions, while an acrylic liner provides excellent protection in cold environments.



LATEX CRINKLE
COATING

THE IDEAL COLD WEATHER
WORK GLOVE

The [14-1425](#) is constructed with a Hi-Vis acrylic shell for easy detection while providing economical cold weather insulation without trapping in moisture. A latex crinkle coating gives workers an excellent grip in wet or dry and remains flexible in extreme cold conditions.

GENERAL PURPOSE GLOVES

ATG® NITRILE MICRO-FOAM COATED



MaxiFlex[®] ULTIMATE™
24-27 9(L)
CE
ATG
Dermatologically Approved
NITRILE MICRO-FOAM COATING
PATENT No. 8,473,288 B2
MADE IN USA

MAXIMUM COMFORT & COOLNESS

AD-APT[®] TO NEXT GENERATION COMFORT

- Exclusive AD-APT[®] technology keeps hands drier and smelling fresh and clean
- Proprietary nitrile Micro-Foam coating technology provides 360° breathability and up to twice the abrasion resistance
- Maximum comfort and dexterity helps increase worker productivity and compliance



#1 INDUSTRIAL GLOVE IN AMERICA

JUST GOT BETTER

MAXIFLEX[®] ULTIMATE™ IS NOW THE “ULTIMATE” IN ALL-DAY COMFORT AND IMPROVED PRODUCTIVITY

GENERAL PURPOSE GLOVES

ATG® NITRILE MICRO-FOAM COATED



NITRILE
MICRO-FOAM
COATING

MAXIFLEX® ULTIMATE™

- High tactile sensitivity and dexterity
- Designed and developed with 360° breathability through the use of ATG's patented AIRtech® platform, now improved using game-changing technology. Introducing the next generation MaxiFlex® Ultimate™
- Micro-cup finish provides excellent dry grip and is compatible with light oils
- Made with component materials that comply with federal regulations for food contact 21CFR 170-199
- Silicone free

APPLICATIONS: *Finishing and Inspection, Handling of Small Components, Primary, Secondary and Final Assembly, Maintenance, Logistics and Warehousing, Operating Tools and Instruments, Wiring Operations*

25% THINNER
THAN MOST FOAM
NITRILE GLOVES
& OFFERS TWICE
THE MECHANICAL
PERFORMANCE



▲ 34-875



▲ 34-876



▲ 34-8014



HI-VISIBILITY

▲ 34-874FY

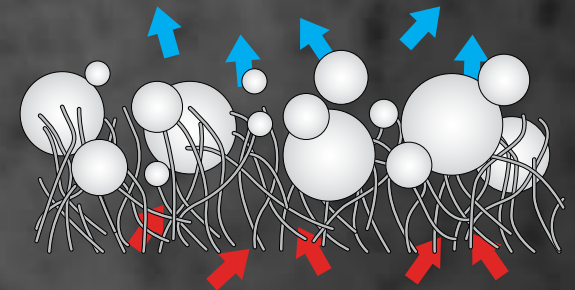

AIRtech®, which enables 360° breathability of the hand, is delivered through our patented foam technology.

MAXIFLEX® ULTIMATE™

| STYLE NUMBER | EN 388 | 21 CFR | CFIA | COATING | COATING COVERAGE | COATING COLOR | LINER MATERIAL | LINER COLOR | CONSTRUCTION | GAUGE | SIZES |
|-----------------|--------|--------|------|--------------------|-----------------------------|-----------------|----------------|-----------------|----------------------|-------|------------|
| 34-874 | 4131 | Yes | Yes | Nitrile Micro-Foam | Palm & Fingertips | ☐ Black | Nylon / Lycra® | ☐ Gray | Coated Seamless Knit | 15 | XXS - XXXL |
| 34-875 | 4131 | Yes | Yes | Nitrile Micro-Foam | Palm, Full Finger & Knuckle | ☐ Black | Nylon / Lycra® | ☐ Gray | Coated Seamless Knit | 15 | XXS - XL |
| 34-876 | 4131 | Yes | Yes | Nitrile Micro-Foam | Full | ☐ Black | Nylon / Lycra® | ☐ Gray | Coated Seamless Knit | 15 | XXS - XXL |
| 34-8014 | 4131 | Yes | Yes | Nitrile Micro-Foam | Palm & Fingertips | ☐ Black | Nylon / Lycra® | ☐ Hi-Vis Orange | Coated Seamless Knit | 15 | S - XXL |
| 34-874FY | 4131 | Yes | Yes | Nitrile Micro-Foam | Palm & Fingertips | ■ Hi-Vis Yellow | Nylon / Lycra® | ■ Hi-Vis Yellow | Coated Seamless Knit | 15 | S - XXL |

GENERAL PURPOSE GLOVES

ATG® NITRILE MICRO-FOAM COATED

RAISED MICRO DOTS

FOR MORE DURABILITY



▲ 34-844



▲ 34-845



▲ 34-846



▲ 34-8745

NITRILE
MICRO-FOAM
COATING

MAXIFLEX® ENDURANCE™

- High tactile sensitivity and dexterity
- Patented micro-foam nitrile coating offers 360° breathability for increased comfort
- Micro-cup finish provides excellent dry grip and compatible with light oils
- Made with component materials that comply with federal regulations for food contact 21CFR 170-199
- Micro dots provide increased durability

APPLICATIONS: *Finishing and Inspection, Handling of Small Components, Primary, Secondary and Final Assembly, Maintenance, Logistics and Warehousing, Operating Tools and Instruments, Wiring Operations*

MAXIFLEX® ENDURANCE™

| STYLE NUMBER | EN 388 | 21 CFR | CFIA | COATING | COATING COVERAGE | COATING COLOR | LINER MATERIAL | LINER COLOR | CONSTRUCTION | GAUGE | SIZES |
|----------------|--------|--------|------|--------------------|-----------------------------|--------------------------------|----------------|-------------------------------|----------------------|-------|-----------|
| 34-844 | 4131 | Yes | Yes | Nitrile Micro-Foam | Palm & Fingertips | <input type="checkbox"/> Black | Nylon / Lycra® | <input type="checkbox"/> Gray | Coated Seamless Knit | 15 | XXS - XL |
| 34-845 | 4131 | Yes | Yes | Nitrile Micro-Foam | Palm, Full Finger & Knuckle | <input type="checkbox"/> Black | Nylon / Lycra® | <input type="checkbox"/> Gray | Coated Seamless Knit | 15 | XXS - XL |
| 34-846 | 4131 | Yes | Yes | Nitrile Micro-Foam | Full | <input type="checkbox"/> Black | Nylon / Lycra® | <input type="checkbox"/> Gray | Coated Seamless Knit | 15 | XXS - XXL |
| 34-8745 | 4131 | Yes | Yes | Nitrile Micro-Foam | Full | <input type="checkbox"/> Black | Nylon / Lycra® | <input type="checkbox"/> Gray | Coated Seamless Knit | 15 | S - XXL |

36% LIGHTER & 30% THINNER UNPARALLELED DEXTERITY & TACTILE SENSITIVITY



▲ 34-274

▲ 34-275



▲ 34-244

▲ 34-245



MAXIFLEX® ELITE™

- Maximum dexterity and tactility
- 360° breathability
- Micro-cup finish gives excellent dry grip and is compatible with light oils
- Silicone free
- Made with component materials that comply with federal regulations for food contact 21CFR 170-199

APPLICATIONS: *Finishing and Inspection, Handling of Small Components, Assembly, Maintenance, Logistics & Warehousing, Wiring Operations*



MAXIFLEX® ELITE™

| STYLE NUMBER | EN 388 | 21 CFR | CFIA | COATING | COATING COVERAGE | COATING COLOR | LINER MATERIAL | LINER COLOR | CONSTRUCTION | GAUGE | SIZES |
|---------------|--------|--------|------|--------------------|-----------------------------|---------------|----------------|-------------|----------------------|-------|----------|
| 34-274 | 4121 | Yes | Yes | Nitrile Micro-Foam | Palm & Fingertips | □ Blue | Nylon / Lycra® | □ Blue | Coated Seamless Knit | 18 | XS - XXL |
| 34-275 | 4121 | Yes | Yes | Nitrile Micro-Foam | Palm, Full Finger & Knuckle | □ Blue | Nylon / Lycra® | □ Blue | Coated Seamless Knit | 18 | XS - XL |
| 34-244 | 4121 | Yes | Yes | Nitrile Micro-Foam | Palm & Fingertips | □ Blue | Nylon / Lycra® | □ Blue | Coated Seamless Knit | 18 | XS - XL |
| 34-245 | 4121 | Yes | Yes | Nitrile Micro-Foam | Palm, Full Finger & Knuckle | □ Blue | Nylon / Lycra® | □ Blue | Coated Seamless Knit | 18 | XS - XL |

GENERAL PURPOSE GLOVES

ATG® NITRILE MICRO-FOAM COATED



MAXIFOAM® PREMIUM 34-800

- High dexterity and tactility
- Tough foam nitrile coating for improved grip and durability
- Silicone free

APPLICATIONS: *Automotive, Handling Small Oily Parts and Components, General Assembly, Machining, Micro-engineering, Painting, Horticulture and Maintenance*



MAXIFOAM® LITE 34-900

- High dexterity and tactility
- Lighter coating for improved flexibility and dexterity
- Silicone free

APPLICATIONS: *Automotive, Handling Small Oily Parts and Components, General Assembly, Machining, Micro-engineering, Painting, Horticulture and Maintenance*



COTTON PLATED



MAXIFLEX® COMFORT™ 34-9025

- Maximum dexterity and tactility
- 360° breathability
- Micro-cup finish gives excellent dry grip and is compatible with light oils
- Cotton plated for additional comfort

APPLICATIONS: *Finishing and Inspection, Handling of Small Components, Assembly, Maintenance, Logistics and Warehousing, Wiring Operations*



MADE WITH ALOE VERA & VITAMIN E



MAXIFLEX® ACTIVE™ 34-8264

- High tactile sensitivity and dexterity
- 360° breathability
- Micro-cup finish provides excellent dry grip and is compatible with light oils
- Silicone free
- Delivers a "well-being" effect through the release of special ingredients, including aloe vera and Vitamin E

APPLICATIONS: *Finishing and Inspection, Handling of Small Components, Primary, Secondary and Final Assembly, Maintenance, Logistics and Warehousing, Operating Tools and Instruments, Wiring Operations*

MAXIFOAM®

| STYLE NUMBER | EN 388 | 21 CFR | CFIA | COATING | COATING COVERAGE | COATING COLOR | LINER MATERIAL | LINER COLOR | CONSTRUCTION | GAUGE | SIZES |
|---------------|--------|--------|------|--------------------|-------------------|---------------|----------------|-------------|----------------------|-------|----------|
| 34-800 | 4131 | Yes | Yes | Nitrile Micro-Foam | Palm & Fingertips | ☐ Gray | Nylon / Lycra® | ■ White | Coated Seamless Knit | 15 | XS - XXL |
| 34-900 | 3121 | Yes | Yes | Nitrile Micro-Foam | Palm & Fingertips | ☐ Black | Nylon / Lycra® | ☐ Gray | Coated Seamless Knit | 15 | XXS - XL |

MAXIFLEX® COMFORT™

| | | | | | | | | | | | |
|----------------|------|-----|-----|--------------------|-----------------------------|--------|-------------------------|--------|----------------------|----|---------|
| 34-9025 | 3121 | Yes | Yes | Nitrile Micro-Foam | Palm, Full Finger & Knuckle | ☐ Blue | Nylon / Cotton / Lycra® | ☐ Gray | Coated Seamless Knit | 13 | XS - XL |
|----------------|------|-----|-----|--------------------|-----------------------------|--------|-------------------------|--------|----------------------|----|---------|

MAXIFLEX® ACTIVE™

| | | | | | | | | | | | |
|----------------|------|-----|-----|--------------------|-------------------|--------------|----------------|--------------|----------------------|----|----------|
| 34-824 | 4131 | Yes | Yes | Nitrile Micro-Foam | Palm & Fingertips | ☐ Light Blue | Nylon / Lycra® | ■ Light Blue | Coated Seamless Knit | 15 | XS - XL |
| 34-8264 | 4131 | Yes | Yes | Nitrile Micro-Foam | Palm & Fingertips | ☐ Pink | Nylon / Lycra® | ■ Light Pink | Coated Seamless Knit | 15 | XXS - XL |

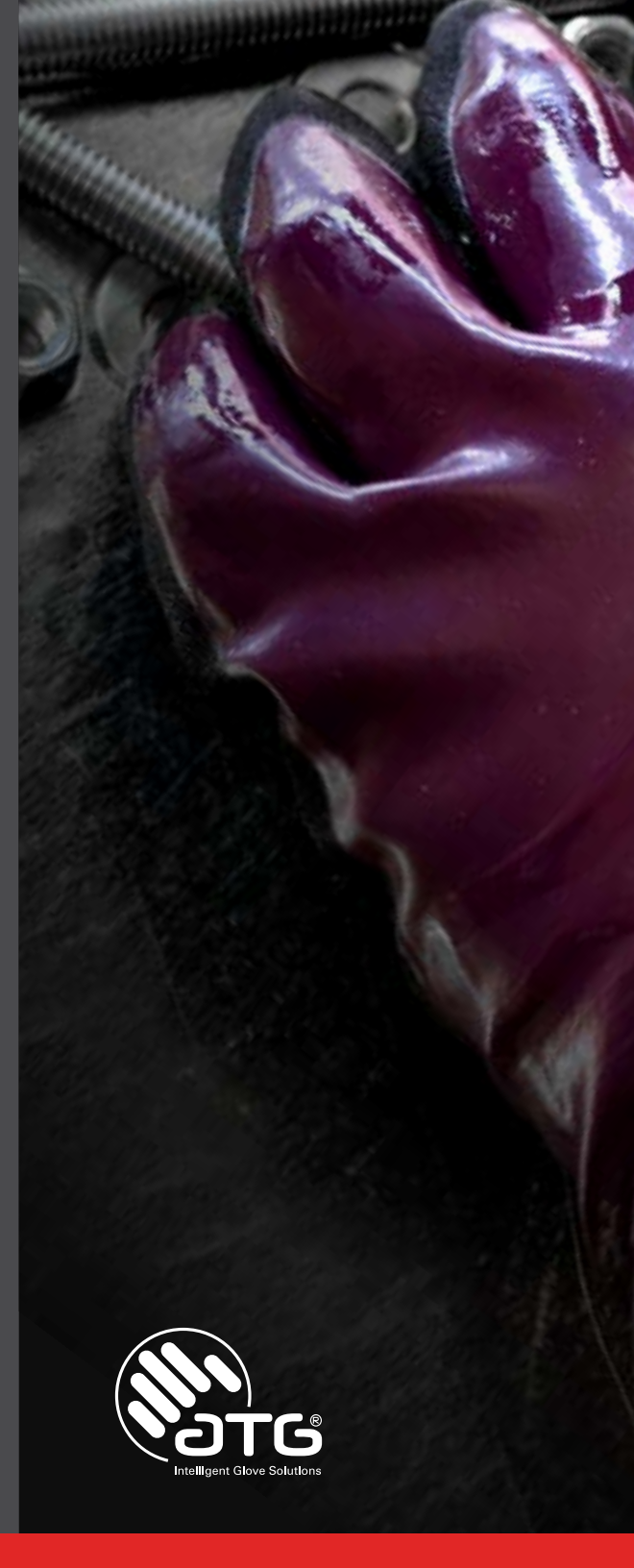

GENERAL PURPOSE GLOVES

ATG® NITRILE MICRO-FOAM COATED



▲ 56-424

THERMAL INSULATED

▲ 56-451

MAXIDRY® & MAXIDRY® ZERO

- High dexterity
- Comfortable
- Micro-cup, nonslip grip finish allows for a controlled and superior grip in oily and wet applications
- Dark colors hide dirt

APPLICATIONS: *Engine and Powertrain, Gearbox and Transmission Assembly, General Handling, Handling Small Castings, Handling of Small Components, Light Metal Fabrication and Parts Handling, Shock Absorber Assembly, Maintenance*



EN 511 MAXIDRY® ZERO™ | 56-451
FLEXIBLE TO -22°F



EN 374 MAXIDRY® PLUS™ | 56-530
LOW-LEVEL CHEMICAL RESISTANCE

SUPERIOR GRIP IN OILY & WET APPLICATIONS

MAXIDRY®

| STYLE NUMBER | EN 388 | EN 511 | CFIA | COATING | COATING COVERAGE | COATING COLOR | LINER MATERIAL | LINER COLOR | CONSTRUCTION | GAUGE | SIZES |
|--------------|--------|--------|------|--------------------|-----------------------------|------------------|----------------|-------------|----------------------|-------|----------|
| 56-424 | 4121 | --- | Yes | Nitrile Micro-Foam | Palm & Fingertips | ☐ Black / Purple | Nylon / Lycra® | ☐ Gray | Coated Seamless Knit | 15 | XS - XXL |
| 56-425 | 4121 | --- | Yes | Nitrile Micro-Foam | Palm, Full Finger & Knuckle | ☐ Black / Purple | Nylon / Lycra® | ☐ Gray | Coated Seamless Knit | 15 | S - XXL |
| 56-426 | 4111 | --- | Yes | Nitrile Micro-Foam | Full | ☐ Black / Purple | Nylon / Lycra® | ■ Neutral | Coated Seamless Knit | 15 | S - XXL |

MAXIDRY® ZERO™

| | | | | | | | | | | | |
|--------|------|-----|-----|--------------------|------|------------------|----------------|--------|----------------------|----|---------|
| 56-451 | 4232 | 111 | Yes | Nitrile Micro-Foam | Full | ☐ Black / Purple | Nylon / Lycra® | ☐ Gray | Coated Seamless Knit | 15 | S - XXL |
|--------|------|-----|-----|--------------------|------|------------------|----------------|--------|----------------------|----|---------|

MAXIDRY® PLUS™

| | | | | | | | | | | | |
|--------|------|-----|-----|--------------------|------|------------------|----------------|--------|----------------------|----|---------|
| 56-530 | 4121 | --- | Yes | Nitrile Micro-Foam | Full | ☐ Black / Purple | Nylon / Lycra® | ☐ Blue | Coated Seamless Knit | 13 | S - XXL |
|--------|------|-----|-----|--------------------|------|------------------|----------------|--------|----------------------|----|---------|

GENERAL PURPOSE GLOVES

G-TEK® GP™ NITRILE COATED



34-500

- Excellent dexterity
- Comfortable
- Excellent dry grip
- Excellent abrasion protection

APPLICATIONS: *Assembly, Parts Handling, Manufacturing, Material Handling*



G-TEK® GP™ 34-400

- Superior dexterity and tactile sensitivity
- Comfortable
- Excellent dry grip and resistance to oils
- Excellent wet grip

APPLICATIONS: *Assembly, Electronics, Inspection, Small Parts Handling, Manufacturing, Material Handling, Oily Parts Handling*

18 GAUGE



G-TEK® GP™ 34-C229

- Excellent dexterity
- Comfortable
- Excellent dry grip
- Excellent abrasion protection

APPLICATIONS: *Assembly, Parts Handling, Manufacturing, Material Handling*



IDEAL FOR GENERAL ASSEMBLY & PARTS HANDLING

G-TEK® GP™

| STYLE NUMBER | EN 388 | COATING | COATING COVERAGE | COATING COLOR | LINER MATERIAL | LINER COLOR | CONSTRUCTION | GAUGE | SIZES |
|----------------|--------|----------------------|---------------------|--|---------------------|---|----------------------|-------|----------|
| 34-500 | 4121 | Nitrile MicroSurface | Palm & Fingertips | <input type="checkbox"/> Black | Nylon | <input type="checkbox"/> Blue | Coated Seamless Knit | 13 | XS - XXL |
| 34-400 | 2121 | Nitrile MicroSurface | Palm & Fingertips | <input type="checkbox"/> Black | Nylon | <input type="checkbox"/> Green | Coated Seamless Knit | 18 | XS - XXL |
| 34-300 | 4121 | Nitrile MicroSurface | Palm & Fingertips | <input type="checkbox"/> Black | Polyester | <input type="checkbox"/> Gray | Coated Seamless Knit | 13 | XS - XXL |
| 41-1415 | 4432 | Nitrile Foam | Full, Double-Dipped | <input checked="" type="checkbox"/> Black / Blue | Polyester / Acrylic | <input checked="" type="checkbox"/> Hi-Vis Yellow | Coated Seamless Knit | 13 | S - XL |
| 34-C232 | 4121 | Nitrile Foam | Palm & Fingertips | <input type="checkbox"/> Black | Nylon | <input type="checkbox"/> Gray | Coated Seamless Knit | 13 | XS - XL |
| 34-C234 | 4131 | Nitrile Foam | Palm & Fingertips | <input type="checkbox"/> Gray | Nylon | <input type="checkbox"/> White | Coated Seamless Knit | 13 | XS - XL |
| 34-225 | 4131 | Nitrile Smooth | Palm & Fingertips | <input type="checkbox"/> Gray | Nylon | <input type="checkbox"/> White | Coated Seamless Knit | 13 | XS - XL |
| 34-C229 | 4131 | Nitrile Smooth | Palm & Fingertips | <input type="checkbox"/> Blue | Nylon | <input type="checkbox"/> White | Coated Seamless Knit | 13 | S - XL |
| 38-1410 | 4131 | Nitrile MicroFinish® | Palm & Fingertips | <input type="checkbox"/> Black | Cotton / Polyester | <input type="checkbox"/> Gray | Coated Seamless Knit | 10 | S - XL |
| 38-1460 | 3122 | Nitrile MicroFinish® | Palm & Fingertips | <input type="checkbox"/> Black | Cotton / Polyester | <input type="checkbox"/> Gray | Coated Seamless Knit | 10 | S - XXL |

PRIME

| | | | | | | | | | |
|---------------|------|---------------------------|-----------------------------|--------------------------------|-------|-------------------------------|----------------------|----|----------|
| 38-620 | 4131 | Nitrile Foam | Palm & Fingertips | <input type="checkbox"/> Black | Nylon | <input type="checkbox"/> Gray | Coated Seamless Knit | 15 | XS - XXL |
| 38-625 | 4131 | Nitrile Foam | Palm, Full Finger & Knuckle | <input type="checkbox"/> Black | Nylon | <input type="checkbox"/> Gray | Coated Seamless Knit | 15 | XS - XXL |
| 38-630 | 4131 | Nitrile Foam - Micro Dots | Palm & Fingertips | <input type="checkbox"/> Black | Nylon | <input type="checkbox"/> Gray | Coated Seamless Knit | 15 | XS - XXL |
| 38-635 | 4131 | Nitrile Foam - Micro Dots | Palm, Full Finger & Knuckle | <input type="checkbox"/> Black | Nylon | <input type="checkbox"/> Gray | Coated Seamless Knit | 15 | XS - XXL |



PRIME 38-620

- High comfort and dexterity
- Good grip in dry, wet and slightly oily conditions
- Knit wrist helps prevent dirt and debris from entering glove

APPLICATIONS: *Small Oily Parts and Components, Machining, General Assembly, Automotive*



G-TEK® GP™ 41-1415

- Nitrile foam coating provides superior grip in dry, wet and oily applications
- Hi-Vis color for better visibility
- Quickly evaporates moisture from the skin

APPLICATIONS: *General Maintenance, Cold Protection*

DOUBLE-DIPPED

GENERAL PURPOSE GLOVES

G-TEK® GP™ LATEX COATED

HEAVY DUTY WITH
ENHANCED GRIP IN
**WET OR DRY
CONDITIONS**

FULL WET PROTECTION



LATEX
MICROSURFACE
COATING

G-TEK® GP™ 55-1600

- Waterproof coating keeps hands dry
- Excellent dexterity and comfort
- Double-coated palm for added durability
- Micro-textured latex coating provides superior grip in wet or dry conditions

APPLICATIONS: *Assembly, Construction, Inspection, Material and Refuse Handling, Landscaping, Masonry and Concrete*



LATEX CRINKLE
COATING

G-TEK® GP™ 39-C1300

- Good grip in dry and slightly wet, non-oily conditions
- Better comfort against skin
- Fully coated thumb for extended wear
- Cotton blend for enhanced comfort

APPLICATIONS: *Assembly, Construction, Material Handling, Glass Handling, Refuse Handling, Landscaping*



LATEX
MICROSURFACE
COATING

G-TEK® GP™ 55-AG316

- High tactile sensitivity and dexterity
- Extremely light feel
- Excellent grip in dry and wet, non-oily conditions
- Better comfort against skin

APPLICATIONS: *Assembly, Construction, Inspection, Material Handling, Glass Handling, Landscaping*



LATEX CRINKLE
COATING

G-TEK® GP™ 41-1425

- Latex crinkle coating provides superior grip in wet and dry conditions
- Hi-Vis coloring makes product very easy to see
- Acrylic gloves provide economical cold weather protection

APPLICATIONS: *General Maintenance, Cold Protection*

COLD WEATHER USE

G-TEK® GP™

| STYLE NUMBER | EN 388 | COATING | COATING COVERAGE | COATING COLOR | LINER MATERIAL | LINER COLOR | CONSTRUCTION | GAUGE | SIZES |
|-----------------|--------|--------------------|---------------------|--|----------------------------|---|----------------------|-------|----------|
| 39-C1500 | 3242 | Latex MicroFinish® | Palm & Fingertips | <input type="checkbox"/> Brown | Cotton / Polyester | <input type="checkbox"/> Brown | Coated Seamless Knit | 10 | XS - XL |
| 39-C1600 | 3242 | Latex MicroFinish® | Palm & Fingertips | <input checked="" type="checkbox"/> Blue | Cotton / Polyester | <input type="checkbox"/> Gray | Coated Seamless Knit | 10 | XS - XXL |
| 55-AG315 | 2121 | Latex MicroSurface | Palm & Fingertips | <input type="checkbox"/> Black | Polyester | <input checked="" type="checkbox"/> Rose Pink | Coated Seamless Knit | 13 | XS - XL |
| 55-AG316 | 2121 | Latex MicroSurface | Palm & Fingertips | <input type="checkbox"/> Black | Polyester | <input checked="" type="checkbox"/> Aqua Blue | Coated Seamless Knit | 13 | XS - XL |
| 55-AG317 | 2121 | Latex MicroSurface | Palm & Fingertips | <input type="checkbox"/> Black | Polyester | <input checked="" type="checkbox"/> Hi-Vis Yellow | Coated Seamless Knit | 13 | XS - XL |
| 55-1600 | 2131 | Latex MicroSurface | Full, Double-Dipped | <input checked="" type="checkbox"/> Blue / Dark Blue | Nylon | <input checked="" type="checkbox"/> Blue | Coated Seamless Knit | 13 | S - XXL |
| 41-1425 | 4131 | Latex Crinkle | Palm & Fingertips | <input type="checkbox"/> Black | Acrylic | <input checked="" type="checkbox"/> Hi-Vis Yellow | Coated Seamless Knit | 10 | S - XXL |
| 39-1310 | 2243 | Latex Crinkle | Palm & Fingertips | <input checked="" type="checkbox"/> Blue | Cotton / Polyester | <input type="checkbox"/> Gray | Coated Seamless Knit | 10 | S - XL |
| 39-C1300 | 2242 | Latex Crinkle | Palm & Fingertips | <input checked="" type="checkbox"/> Blue | Premium Cotton / Polyester | <input type="checkbox"/> Gray | Coated Seamless Knit | 10 | XS - XXL |
| 39-C1305 | 2242 | Latex Crinkle | Palm & Fingertips | <input checked="" type="checkbox"/> Blue | Cotton / Polyester | <input type="checkbox"/> Gray | Coated Seamless Knit | 10 | XS - XL |
| 39-C1375 | 2243 | Latex Crinkle | Palm & Fingertips | <input type="checkbox"/> Black | Polyester | <input type="checkbox"/> Black | Coated Seamless Knit | 10 | S - XL |
| 39-C122 | 2011 | Latex Smooth | Palm & Fingertips | <input checked="" type="checkbox"/> Blue | Cotton / Polyester | <input checked="" type="checkbox"/> Natural | Coated Seamless Knit | 7 | XS, S, L |
| 39-C121 | 2011 | Latex Smooth | Palm & Fingertips | <input checked="" type="checkbox"/> Red | Cotton / Polyester | <input checked="" type="checkbox"/> Natural | Coated Seamless Knit | 7 | S & L |
| 39-C120 | 2011 | Latex Smooth | Palm & Fingertips | <input checked="" type="checkbox"/> Blue | Cotton / Polyester | <input checked="" type="checkbox"/> Natural | Coated Seamless Knit | 7 | L |

GENERAL PURPOSE GLOVES

G-TEK® GP™ POLYURETHANE COATED

G-Tek® Touch
Seamless Knit Polyester Glove with Polyurethane
& Fingers - Touch Screen Compatible
33-GT125
DESCRIPTION



G-TEK® TOUCH 33-GT125

- High dexterity
- Touch screen compatible
- Good grip in dry and wet conditions with light oils
- Good abrasion protection
- Dark colors hide dirt

APPLICATIONS: *Assembly, Parts Handling, Manufacturing, Material Handling*

FLEXIBLE, TOUGH & RELIABLE FOR ALL JOBS



ENHANCED TOUCH SCREEN PERFORMANCE

STATIC WIRED THUMB, INDEX FINGER & MIDDLE FINGER



G-TEK® GP™

| STYLE NUMBER | EN 388 | COATING | COATING COVERAGE | COATING COLOR | LINER MATERIAL | LINER COLOR | CONSTRUCTION | GAUGE | SIZES |
|-----------------|--------|---------------------|-------------------|-----------------|----------------|-----------------|----------------------|-------|-----------|
| 33-115 | 3121 | Polyurethane Smooth | Palm & Fingertips | ■ White | Polyester | ■ White | Coated Seamless Knit | 13 | XS - XXL |
| 33-125 | 4131 | Polyurethane Smooth | Palm & Fingertips | ■ White | Nylon | ■ White | Coated Seamless Knit | 13 | XS - XXL |
| 33-325 | 4131 | Polyurethane Smooth | Palm & Fingertips | □ Black | Nylon | □ Black | Coated Seamless Knit | 13 | XS - XXL |
| 33-425LY | 3131 | Polyurethane Smooth | Palm & Fingertips | ■ Bright Yellow | Nylon | ■ Bright Yellow | Coated Seamless Knit | 13 | XS - XXL |
| 33-425OR | 3131 | Polyurethane Smooth | Palm & Fingertips | ■ Bright Orange | Nylon | ■ Bright Orange | Coated Seamless Knit | 13 | XS - XXL |
| 33-825 | 3121 | Polyurethane Smooth | Palm & Fingertips | □ Black | Nylon | □ Green | Coated Seamless Knit | 13 | XS - XXL |
| 33-B115 | 3121 | Polyurethane Smooth | Palm & Fingertips | □ Black | Polyester | □ Black | Coated Seamless Knit | 13 | XS - XXL |
| 33-B125 | 4131 | Polyurethane Smooth | Palm & Fingertips | □ Black | Nylon | □ Black | Coated Seamless Knit | 13 | XS - XXL |
| 33-G115 | 3121 | Polyurethane Smooth | Palm & Fingertips | □ Gray | Polyester | □ Gray | Coated Seamless Knit | 13 | XS - XXL |
| 33-G125 | 4131 | Polyurethane Smooth | Palm & Fingertips | □ Gray | Nylon | □ Gray | Coated Seamless Knit | 13 | XS - XXXL |

G-TEK® TOUCH

| | | | | | | | | | |
|-----------------|------|---------------------|-------------------|--------|-----------|--------|----------------------|----|----------|
| 33-GT125 | 4131 | Polyurethane Smooth | Palm & Fingertips | □ Gray | Polyester | □ Gray | Coated Seamless Knit | 13 | XS - XXL |
|-----------------|------|---------------------|-------------------|--------|-----------|--------|----------------------|----|----------|

GENERAL PURPOSE GLOVES

G-TEK® GP™ NEOFOAM™ COATED



33-425LY

- High dexterity
- Good grip in dry and wet conditions with light oils
- Good abrasion protection
- Hi-Vis for enhanced visibility

APPLICATIONS: *Assembly, Parts Handling, Manufacturing, Material Handling*



G-TEK® GP™ 33-825

- High dexterity
- Good grip in dry and wet conditions with light oils
- Good abrasion protection
- Dark colors hide dirt

APPLICATIONS: *Assembly, Parts Handling, Manufacturing, Material Handling*



G-TEK® GP™ 33-B125

- High dexterity
- Good grip in dry and wet conditions with light oils
- Excellent abrasion protection
- Thicker coating for increased abrasion resistance
- Dark colors hide dirt

APPLICATIONS: *Assembly, Parts Handling, Manufacturing, Material Handling*

ADVANCED NEOFOAM™ COATING



IDEAL FOR ALL USES



G-TEK® GP™ 34-600

- Excellent dexterity
- Comfortable
- Excellent dry grip
- Touch screen compatible
- Breathable, flexible coating
- Excellent abrasion protection

APPLICATIONS: *Assembly, Parts Handling, Manufacturing, Material Handling*

#1 IN VALUE



FLEXIBLE
TO -4°F



TOUCHSCREEN
COMPATIBLE



12,000
CYCLES OF
ABRASION

G-TEK® GP™

| STYLE NUMBER | EN 388 | COATING | COATING COVERAGE | COATING COLOR | LINER MATERIAL | LINER COLOR | CONSTRUCTION | GAUGE | SIZES |
|---------------|--------|----------|-------------------|---------------|----------------|-------------|----------------------|-------|----------|
| 34-600 | 4121 | Neofoam™ | Palm & Fingertips | □ Black | Nylon | ■ Blue | Coated Seamless Knit | 15 | XS - XXL |

GENERAL PURPOSE GLOVES

COTTON POLYESTER STRING KNITS

ECONOMICAL KNIT GLOVES



COATED IN THE USA



NITRILE
PALM COAT
COATING

◀ 38-N2110PC

- Nitrile coating for improved grip and abrasion resistance
- Lightweight for increased dexterity

APPLICATIONS: *Medium Duty Packaging and Assembly*



PVC
DENSE DOT
COATING

◀ 36-C330PDD

- PVC dots provide enhanced grip, as well as cut and abrasion resistance
- Coated fingertips provide enhanced wear protection
- Ambidextrous

APPLICATIONS: *Light Duty Packaging and Assembly*



COATED IN THE USA



EVERGRIP™
NITRILE MW PATTERN
COATING

◀ 38-720

- "MW" pattern provides enhanced grip and abrasion protection
- Coating will resist melting
- Ambidextrous

APPLICATIONS: *Medium Duty Packaging and Assembly*



PVC DOTTED
COATING

◀ 36-112PD

- Dotted palm provides enhanced grip and abrasion resistance

APPLICATIONS: *Light Duty Packaging and Assembly*



COATED IN THE USA



PVC
BRICK PATTERN
COATING

◀ 37-C110BB

- PVC "brick" pattern provides enhanced grip, as well as cut and abrasion resistance
- Ambidextrous

APPLICATIONS: *Medium Duty Packaging and Assembly*



PVC
CRISS-CROSS
COATING

◀ 39-3013

































































- Criss-cross pattern provides enhanced grip and abrasion resistance
- Ambidextrous

APPLICATIONS: *Heavy Duty Material Handling*

GENERAL PURPOSE GLOVES

COTTON POLYESTER STRING KNITS

GLOVES WITH PVC GRIP

| STYLE NUMBER | COATING | COATING COVERAGE | COATING COLOR | LINER MATERIAL | LINER COLOR | CONSTRUCTION | GAUGE | SIZES |
|-------------------------------|--------------------------------|------------------|--|--------------------|---|-----------------------------------|-------|----------|
| 38-N2110PC | Nitrile Palm | Single-Sided |  Rust | Cotton / Polyester |  Natural | Coated Seamless Knit | 10 | S - XL |
| 38-720 | EverGrip™ Nitrile "MW" Pattern | Double-Sided |  Rust | Cotton |  Natural | Coated Seamless Knit | 7 | S - L |
| 36-110BB | PVC Brick Pattern | Double-Sided |  Blue | Cotton / Polyester |  Natural | Coated Seamless Knit | 7 | S, L |
| 36-110PC-BK | PVC Palm | Single-Sided |  Black | Cotton / Polyester |  Natural | Coated Seamless Knit | 7 | S, L |
| 36-110PC-BL | PVC Palm | Single-Sided |  Blue | Cotton / Polyester |  Natural | Coated Seamless Knit | 7 | S, L |
| 36-110PD | PVC Dot | Single-Sided |  Black | Cotton / Polyester |  Natural | Coated Seamless Knit | 7 | S, L |
| 36-110PDD | PVC Dense Dot | Double-Sided |  Black | Cotton / Polyester |  Natural | Coated Seamless Knit | 7 | S, L, XL |
| 36-110PDD-WT | PVC Dense Dot | Double-Sided |  White | Cotton / Polyester |  Natural | Coated Seamless Knit | 7 | S, L |
| 36-110VV | PVC "V" Pattern | Double-Sided |  Blue | Cotton / Polyester |  Natural | Coated Seamless Knit | 7 | S, L |
| 36-112PDD | PVC Dense Dot | Double-Sided |  Black | Cotton / Polyester |  Natural | Coated Seamless Knit | 7 | L |
| 36-C330PD | PVC Dot | Single-Sided |  Blue | Cotton / Polyester |  Natural | Coated Seamless Knit | 7 | S, L |
| 36-C330PDD | PVC Dense Dot | Double-Sided |  Blue | Cotton / Polyester |  Natural | Coated Seamless Knit | 7 | S, L |
| 37-C110B | PVC Brick Pattern | Single-Sided |  Blue | Cotton / Polyester |  Natural | Coated Seamless Knit | 7 | S, L |
| 37-C110BB | PVC Brick Pattern | Double-Sided |  Blue | Cotton / Polyester |  Natural | Coated Seamless Knit | 7 | S, L |
| 37-C110PC-BK | PVC Palm | Single-Sided |  Black | Cotton / Polyester |  Natural | Coated Seamless Knit | 7 | S, L |
| 37-C110PC-BL | PVC Palm | Single-Sided |  Blue | Cotton / Polyester |  Natural | Coated Seamless Knit | 7 | L |
| 37-C110PD | PVC Dot | Single-Sided |  Black | Cotton / Polyester |  Natural | Coated Seamless Knit | 7 | S, L |
| 37-C110PDD | PVC Dense Dot | Double-Sided |  Black | Cotton / Polyester |  Natural | Coated Seamless Knit | 7 | XS, S, L |
| 37-C110PDD-BL | PVC Dense Dot | Double-Sided |  Blue | Cotton / Polyester |  Natural | Coated Seamless Knit | 7 | S, L |
| 37-C110PDD-WT | PVC Dense Dot | Double-Sided |  White | Cotton / Polyester |  Natural | Coated Seamless Knit | 7 | S, L |
| 37-C112PDD | PVC Dense Dot | Double-Sided |  Black | Cotton / Polyester |  Natural | Coated Seamless Knit | 7 | S, L |
| 37-C119PD | PVC Dot | Single-Sided |  Black | Cotton / Polyester |  Natural | Coated Seamless Knit, Half-Finger | 7 | S, L |
| 37-C119PDD | PVC Dense Dot | Double-Sided |  Black | Cotton / Polyester |  Natural | Coated Seamless Knit, Half-Finger | 7 | S, L |
| 37-C2110PC-BL | PVC Palm | Single-Sided |  Blue | Cotton / Polyester |  Natural | Coated Seamless Knit | 7 | S, L |
| 37-C2110PC-RT | PVC Palm | Single-Sided |  Rust | Cotton / Polyester |  Natural | Coated Seamless Knit | 7 | S, L, XL |
| 37-C2110PD | PVC Dot | Single-Sided |  Black | Cotton / Polyester |  Natural | Coated Seamless Knit | 10 | S, L |
| 37-C2110PDD | PVC Dense Dot | Double-Sided |  Black | Cotton / Polyester |  Natural | Coated Seamless Knit | 10 | S, L |
| 37-C2110PD-WT | PVC Dot | Single-Sided |  White | Cotton / Polyester |  Natural | Coated Seamless Knit | 10 | S, L |
| 37-C500BB-BL | PVC Brick Pattern | Double-Sided |  Blue | Cotton / Polyester |  Gray | Coated Seamless Knit | 7 | L |
| 37-C500PDD | PVC Dense Dot | Double-Sided |  Black | Cotton / Polyester |  Gray | Coated Seamless Knit | 7 | S, L, XL |
| 37-C512PDD-BL | PVC Dense Dot | Double-Sided |  Blue | Cotton / Polyester |  Natural | Coated Seamless Knit | 7 | L |
| 39-3013 | PVC Honeycomb Criss-Cross | Double-Sided |  Orange | Polyester |  Orange | Coated Seamless Knit | 10 | S - XL |

MULTIPLE PATTERNS TO MEET YOUR NEEDS

GENERAL PURPOSE GLOVES

COTTON POLYESTER STRING KNITS

MULTI-USE KNITS IN VARIOUS WEIGHTS



35-C103

- Ambidextrous
- Made with component materials that comply with federal regulations for food contact 21CFR 170-199
- Cotton blend for enhanced comfort

APPLICATIONS: *General Tasks, May Also Be Used as a Glove Liner*



35-CB604

- Ambidextrous
- Made with component materials that comply with federal regulations for food contact 21CFR 170-199
- Heavyweight for added durability
- Extended cuff for additional forearm protection
- Cotton blend for enhanced comfort

APPLICATIONS: *General Tasks, May Also Be Used as a Glove Liner*

UNCOATED COTTON/POLYESTER GLOVES

| STYLE NUMBER | COATING | LINER MATERIAL | COLOR | CONSTRUCTION | GAUGE | WEIGHT | SIZES |
|--------------------------|----------|--------------------|------------------|------------------------------|-------|-------------|----------|
| 35-C104 | Uncoated | Cotton / Polyester | ■ Natural | Seamless Knit | 7 | Standard | XS - L |
| 35-C103 | Uncoated | Cotton / Polyester | ■ Natural | Seamless Knit | 7 | Economy | S, L |
| 35-C510 | Uncoated | Cotton / Polyester | ■ Natural | Seamless Knit | 7 | Extra Heavy | S, L |
| 35-G510 | Uncoated | Cotton / Polyester | □ Gray | Seamless Knit | 7 | Extra Heavy | S, L |
| 35-CB604 | Uncoated | Cotton / Polyester | ■ Bleached White | Seamless Knit, Extended Cuff | 7 | Extra Heavy | S, L |
| 35-C410 | Uncoated | Cotton / Polyester | ■ Natural | Seamless Knit | 7 | Heavy | S, L |
| 35-G410 | Uncoated | Cotton / Polyester | □ Gray | Seamless Knit | 7 | Heavy | S, L |
| 35-C110 | Uncoated | Cotton / Polyester | ■ Natural | Seamless Knit | 7 | Medium | XS, S, L |
| 35-C115 | Uncoated | Cotton / Polyester | ■ Natural | Seamless Knit | 7 | Medium | S, L |
| 35-CB110 | Uncoated | Cotton / Polyester | ■ Bleached White | Seamless Knit | 7 | Medium | S, L |
| 35-C119 | Uncoated | Cotton / Polyester | ■ Natural | Seamless Knit, Half-Finger | 7 | Medium | S, L |
| 35-C500 | Uncoated | Cotton / Polyester | □ Gray | Seamless Knit | 7 | Medium | S - XL |
| 35-C2110 | Uncoated | Cotton / Polyester | ■ Natural | Seamless Knit | 10 | Medium | S, L |
| 35-C2113 | Uncoated | Cotton / Polyester | ■ Natural | Seamless Knit | 13 | Light | S, L |

GREAT FOR HANDLING HEAVY OBJECTS AND EQUIPMENT



▲ 55-3253



▲ 55-3243



▲ 55-3271



▲ 55-3274



ARMOR® LATEX GLOVE

- Latex coating provides good grip in dry and slightly wet, non-oily conditions
- Canvas lining for increased comfort
- Clute cut for a roomy fit
- Straight thumb for increased comfort in close-fisted work

APPLICATIONS: *Construction, Glass, Tile, Sheet Metal and Wood Handling, Construction*

ARMOR® LATEX

| STYLE NUMBER | COATING | COATING COVERAGE | COATING COLOR | LINER MATERIAL | CUFF | CONSTRUCTION | WEIGHT | SIZES |
|----------------|---------------|-----------------------------|---------------|----------------|-------------|---------------|----------|-------|
| 55-3253 | Latex Crinkle | Palm, Full Finger & Knuckle | Yellow | Canvas | Safety Cuff | Dipped Fabric | Standard | Men's |
| 55-3271 | Latex Crinkle | Palm, Full Finger & Knuckle | Yellow | Canvas | Knit Wrist | Dipped Fabric | Standard | Men's |
| 55-3273 | Latex Crinkle | Palm, Full Finger & Knuckle | Yellow | Canvas | Safety Cuff | Dipped Fabric | Standard | Men's |
| 55-3243 | Latex Crinkle | Palm, Full Finger & Knuckle | Yellow | Canvas | Safety Cuff | Dipped Fabric | Economy | Men's |
| 55-3274 | Latex Smooth | Palm, Full Finger & Knuckle | Yellow | Jersey | Safety Cuff | Dipped Fabric | Standard | Men's |

GENERAL PURPOSE GLOVES

ARMOR® NITRILE DIPPED FABRIC



NITRILE HEAVY DUTY

ARMOR®

OIL RESISTANT



ARMORFLEX®

- Nitrile coating provides good grip in dry and wet conditions
- Ultra lightweight coating provides enhanced dexterity
- High abrasion resistance
- ActiFresh™ treated to reduce germs and odors

APPLICATIONS: *Handling of Parts, Equipment*



▲ 56-3180



ARMORTUFF®

- Nitrile coating provides good grip in dry and wet conditions
- Ultra lightweight coating provides enhanced dexterity
- High abrasion resistance
- ActiFresh™ treated to reduce germs and odors

APPLICATIONS: *Handling of Parts, Equipment*



▲ 56-3152



ARMORLITE®

- Nitrile coating provides good grip in dry and oily conditions
- Ultra lightweight coating provides enhanced dexterity
- 3" plasticized safety cuff for extra wrist protection and easy donning and doffing
- High abrasion resistance
- ActiFresh™ treated to reduce germs and odors

APPLICATIONS: *Handling of Parts, Equipment*



▲ 56-3176

GENERAL PURPOSE GLOVES

ARMOR® NITRILE DIPPED FABRIC



ARMORTUFF®

- Nitrile coating provides good grip in dry and wet conditions
- Standard-weight nitrile coating provides flexibility
- High abrasion resistance
- ActiFresh™ treated to reduce germs and odors

APPLICATIONS: Heavy Duty Handling of Oily Parts, Equipment

▲ 56-3154



ARMORTUFF XT®

- Nitrile coating provides good grip in dry and wet conditions
- Premium nitrile coating for flexibility and additional protection
- High abrasion resistance
- ActiFresh™ treated to reduce germs and odors

APPLICATIONS: Heavy Duty Handling of Parts, Equipment, Masonry Work

▲ 56-3185



ARMORGRIP®

- Nitrile coating provides good grip in dry and oily conditions
- Premium nitrile coating for flexibility and additional protection
- High abrasion resistance
- ActiFresh™ treated to reduce germs and odors

APPLICATIONS: General Handling, Assembly, Parts Handling, Masonry, Petrochemical, Sheet Metal Handling

▲ 56-3145

EFFECTIVE & AFFORDABLE

HIGH ABRASION RESISTANCE AND MAXIMUM WEARABILITY

ARMOR®

| STYLE NUMBER | COATING | COATING COVERAGE | COATING COLOR | LINER MATERIAL | CUFF | CONSTRUCTION | WEIGHT | SIZES |
|--------------|------------------|-----------------------------|---------------|----------------------|----------------|---------------|-------------|---------|
| 56-3171 | Nitrile Textured | Full | Blue | Interlock | Knit Wrist | Dipped Fabric | Light | XS - XL |
| 56-3176 | Nitrile Textured | Full | Blue | Interlock | 3" Safety Cuff | Dipped Fabric | Light | M - XL |
| 56-3170 | Nitrile Textured | Palm, Full Finger & Knuckle | Blue | Interlock | Knit Wrist | Dipped Fabric | Light | XS - XL |
| 56-3175 | Nitrile Textured | Palm, Full Finger & Knuckle | Blue | Interlock | 3" Safety Cuff | Dipped Fabric | Light | M - XL |
| 56-3147 | Nitrile Rough | Full | Blue | Jersey / Terry Cloth | Safety Cuff | Dipped Fabric | Heavy | L |
| 56-3143 | Nitrile Rough | Palm, Full Finger & Knuckle | Blue | Jersey / Terry Cloth | Knit Wrist | Dipped Fabric | Heavy | L - XL |
| 56-3145 | Nitrile Rough | Palm, Full Finger & Knuckle | Blue | Jersey / Terry Cloth | Safety Cuff | Dipped Fabric | Heavy | M - XL |
| 56-3186 | Nitrile Smooth | Full | Blue | Jersey | Knit Wrist | Dipped Fabric | Heavy | S - XL |
| 56-3195 | Nitrile Smooth | Palm, Full Finger & Knuckle | Blue | Jersey | Safety Cuff | Dipped Fabric | Heavy | S - XL |
| 56-3185 | Nitrile Smooth | Palm, Full Finger & Knuckle | Blue | Jersey | Knit Wrist | Dipped Fabric | Heavy | S - XL |
| 56-3154 | Nitrile Smooth | Full | Blue | Jersey | Safety Cuff | Dipped Fabric | Medium | M - XL |
| 56-3152 | Nitrile Smooth | Full | Blue | Jersey | Knit Wrist | Dipped Fabric | Medium | S - XL |
| 56-3153 | Nitrile Smooth | Palm, Full Finger & Knuckle | Blue | Jersey | Safety Cuff | Dipped Fabric | Medium | L |
| 56-3151 | Nitrile Smooth | Palm, Full Finger & Knuckle | Blue | Jersey | Knit Wrist | Dipped Fabric | Medium | S - XL |
| 56-3180 | Nitrile Smooth | Palm, Full Finger & Knuckle | Green | Interlock | Knit Wrist | Dipped Fabric | Ultraflight | S - XL |

GENERAL PURPOSE GLOVES

DIPPED FABRIC & CLUTE CUT



◀ 59-2115

- Textured vinyl coating provides grip
- Better dexterity than leather
- Jersey lined for comfort
- Seams out
- Reinforced thumb crotch
- Liquid resistant

APPLICATIONS: *Parts Handling, Assembly Work, Dily Applications*



◀ 60-3105

- Nitrile coated cotton provides cut and abrasion protection
- Clute cut for a roomy fit
- Straight thumb increases comfort in close-fisted work
- Fully laminated back
- Cotton lining for enhanced comfort

APPLICATIONS: *Auto Assembly Operations, Sheet Metal, Light Fabrication*



◀ 61-249M

- Vinyl impregnated cotton offers wet and dry grip
- Clute cut for a roomy fit
- Straight thumb increases comfort in close-fisted work
- Stretch vinyl gives better dexterity

APPLICATIONS: *Parts Handling, Assembly Work, Dily Applications*

ECONOMICAL & COMPATIBLE WITH OIL

TEXTURED VINYL COATED GLOVE

| STYLE NUMBER | COATING | COATING COVERAGE | COLOR | LINING | CUFF | CONSTRUCTION | SIZES |
|----------------|---------------------|------------------|----------|-----------|---------|--------------|--------|
| 59-2115 | Textured Vinyl | Full | ■ Yellow | Jersey | Slip-On | Cut-and-Sewn | S - XL |
| 59-2515 | Soft Textured Vinyl | Full | ■ Yellow | Interlock | Slip-On | Cut-and-Sewn | S - XL |

NITRILE COATED COTTON GLOVE

| | | | | | | | |
|----------------|---------|------------------------|---------|--------|---------|-----------|---------------|
| 60-3105 | Nitrile | Full | ■ Blue | Cotton | Slip-On | Clute Cut | Men's M - XL |
| 60-3106 | Nitrile | Full | ■ Blue | Cotton | Slip-On | Clute Cut | Ladies' S - L |
| 60-3107 | Nitrile | Full - Nylon Mesh Back | ■ Blue | Cotton | Slip-On | Clute Cut | Men's M - XL |
| 60-3140 | Nitrile | Full | ■ Brown | Cotton | Slip-On | Clute Cut | S - XL |

VINYL-IMPREGNATED COTTON GLOVE

| | | | | | | | |
|----------------|----------------|------|-------|--------|---------|-----------|---------------|
| 61-249M | Textured Vinyl | Full | ■ Red | Cotton | Slip-On | Clute Cut | Men's M - XL |
| 61-249L | Textured Vinyl | Full | ■ Red | Cotton | Slip-On | Clute Cut | Ladies' S - L |

GENERAL PURPOSE GLOVES

CLUTE CUT DOTTED CANVAS



REFLECTIVE STRIP

▲ 91-910PDL-R



▲ 91-910PDO

CANVAS DOTTED

FOR ADDITIONAL GRIP IN DRY APPLICATIONS

CANVAS DOTTED PALM

| STYLE NUMBER | DOT COLOR | FABRIC | FABRIC COLOR | THUMB | CUFF | CONSTRUCTION | FABRIC WEIGHT | GRADE | SIZES |
|--------------------|----------------|--------|----------------|----------|------------|--------------|---------------|---------|---------|
| 91-910PDL-R | ■ Hi-Vis Green | Canvas | ■ Hi-Vis Green | Straight | Knit Wrist | Clute Cut | 10 oz. | Premium | Men's |
| 91-910PDL | ■ Hi-Vis Green | Canvas | ■ Hi-Vis Green | Straight | Knit Wrist | Clute Cut | 10 oz. | Premium | Men's |
| 91-910PDO | ■ Orange | Canvas | ■ Natural | Straight | Knit Wrist | Clute Cut | 10 oz. | Premium | Men's |
| 91-910PD | □ Black | Canvas | ■ Natural | Straight | Knit Wrist | Clute Cut | 10 oz. | Premium | Men's |
| 91-908PDC | □ Black | Canvas | ■ Natural | Straight | Knit Wrist | Clute Cut | 8 oz. | Premium | Ladies' |
| 91-908PD | □ Black | Canvas | ■ Natural | Straight | Knit Wrist | Clute Cut | 8 oz. | Premium | Men's |
| 91-910PDI | □ Black | Canvas | ■ Natural | Straight | Knit Wrist | Clute Cut | 10 oz. | Economy | Men's |
| 91-908PDI | □ Black | Canvas | ■ Natural | Straight | Knit Wrist | Clute Cut | 8 oz. | Economy | Men's |

GENERAL PURPOSE GLOVES

UNCOATED CLUTE CUT FABRIC

CANVAS FABRIC GLOVES



▲ 90-908I



HI-VIS

▲ 92-918PCO

CANVAS SINGLE PALM GLOVES

| STYLE NUMBER | FABRIC | COLOR | PALM | THUMB | CUFF | CONSTRUCTION | FABRIC WEIGHT | SIZES |
|----------------------------|--------|-----------|--------|----------|---------------------|--------------|---------------|---------|
| 90-908I | Canvas | ■ Natural | Single | Straight | Knit Wrist | Clute Cut | 8 oz. | Men's |
| 90-908CI | Canvas | ■ Natural | Single | Straight | Knit Wrist | Clute Cut | 8 oz. | Ladies' |
| 90-910I | Canvas | ■ Natural | Single | Straight | Knit Wrist | Clute Cut | 10 oz. | Men's |
| 90-912I | Canvas | ■ Natural | Single | Straight | Knit Wrist | Clute Cut | 12 oz. | Men's |
| 90-909I | Canvas | ■ Natural | Single | Wing | Knit Wrist | Clute Cut | 8 oz. | Men's |
| 90-908 | Canvas | ■ Natural | Single | Straight | Knit Wrist | Clute Cut | 8 oz. | Men's |
| 90-908BW | Canvas | ■ Natural | Single | Straight | Knit Wrist | Clute Cut | 8 oz. | Men's |
| 90-908/5KW | Canvas | ■ Natural | Single | Straight | Extended Knit Wrist | Clute Cut | 8 oz. | Men's |
| 90-908C | Canvas | ■ Natural | Single | Straight | Knit Wrist | Clute Cut | 8 oz. | Ladies' |
| 90-908BT | Canvas | ■ Natural | Single | Straight | Band Top | Clute Cut | 8 oz. | Men's |
| 90-910 | Canvas | ■ Natural | Single | Straight | Knit Wrist | Clute Cut | 10 oz. | Men's |
| 90-910C | Canvas | ■ Natural | Single | Straight | Knit Wrist | Clute Cut | 10 oz. | Ladies' |
| 90-910G | Canvas | ■ Natural | Single | Straight | Gauntlet | Clute Cut | 10 oz. | Men's |
| 90-910GA | Canvas | ■ Natural | Single | Straight | Gauntlet | Clute Cut | 10 oz. | Men's |
| 90-912 | Canvas | ■ Natural | Single | Straight | Knit Wrist | Clute Cut | 12 oz. | Men's |

CANVAS DOUBLE PALM GLOVES

| | | | | | | | | |
|----------------------------|-----------------------------|--------------------------|--------|----------|------------|-----------|--------|-------|
| 92-918 | Canvas - Nap In | ■ Natural | Double | Straight | Knit Wrist | Clute Cut | 18 oz. | Men's |
| 92-918O | Canvas - Nap Out | ■ Natural | Double | Straight | Knit Wrist | Clute Cut | 18 oz. | Men's |
| 92-918BT | Canvas - Nap In | ■ Natural | Double | Straight | Band Top | Clute Cut | 18 oz. | Men's |
| 92-918BTO | Canvas - Nap Out | ■ Natural | Double | Straight | Band Top | Clute Cut | 18 oz. | Men's |
| 92-918G | Canvas - Nap In | ■ Natural | Double | Straight | Gauntlet | Clute Cut | 18 oz. | Men's |
| 92-918GO | Canvas - Nap Out | ■ Natural | Double | Straight | Gauntlet | Clute Cut | 18 oz. | Men's |
| 92-918PC | Cotton / Polyester - Nap In | ■ Natural | Double | Straight | Knit Wrist | Clute Cut | 18 oz. | Men's |
| 92-918PCO | Cotton / Polyester - Nap In | ■ Hi-Vis Orange | Double | Straight | Knit Wrist | Clute Cut | 18 oz. | Men's |
| 92-918PCG | Cotton / Polyester - Nap In | ■ Hi-Vis Green | Double | Straight | Knit Wrist | Clute Cut | 18 oz. | Men's |
| 92-918PCY | Cotton / Polyester - Nap In | ■ Hi-Vis Yellow | Double | Straight | Knit Wrist | Clute Cut | 18 oz. | Men's |
| 92-918PCGB | Cotton / Polyester - Nap In | ■ Natural / Hi-Vis Green | Double | Straight | Knit Wrist | Clute Cut | 18 oz. | Men's |

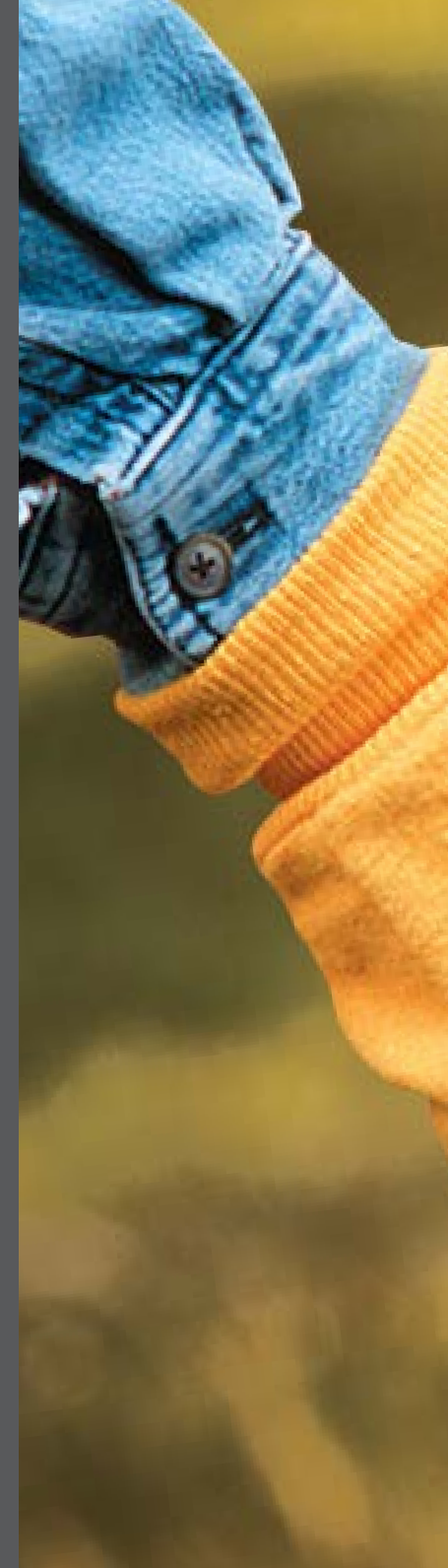

MULTI-PURPOSE CHORE & JERSEY GLOVES

CHORE GLOVES

| STYLE NUMBER | FABRIC | PALM | COLOR | THUMB | CUFF | CONSTRUCTION | WEIGHT | SIZES |
|-------------------------|------------------|--------|-------|----------|------------|--------------|--------|-------|
| 93-548 | Cotton - Nap Out | Double | Green | Straight | Knit Wrist | Clute Cut | Heavy | Men's |
| 93-578G | Cotton - Nap Out | Double | Gold | Straight | Gauntlet | Clute Cut | Heavy | Men's |
| 93-589 | Cotton - Nap Out | Double | Gold | Straight | Band Top | Clute Cut | Heavy | Men's |
| 93-598 | Cotton - Nap Out | Double | Gold | Straight | Knit Wrist | Clute Cut | Heavy | Men's |
| 93-588 | Cotton - Nap Out | Double | Gold | Straight | Knit Wrist | Clute Cut | Medium | Men's |
| 93-568 | Cotton - Nap Out | Single | Gold | Straight | Knit Wrist | Clute Cut | Light | Men's |

▲ [93-568](#)

JERSEY GLOVES

| STYLE NUMBER | FABRIC | COLOR | THUMB | CUFF | CONSTRUCTION | WEIGHT | SIZES |
|---------------------------|--------------------------------------|---------|----------|------------|--------------|-------------|---------|
| 95-890 | 100% Cotton | Brown | Straight | Knit Wrist | Clute Cut | Extra Heavy | Men's |
| 95-809C | 100% Cotton | Brown | Straight | Knit Wrist | Clute Cut | Heavy | Ladies' |
| 95-809 | 100% Cotton | Brown | Straight | Knit Wrist | Clute Cut | Heavy | Men's |
| 95-864 | Cotton / Polyester, Red Jersey Lined | Brown | Straight | Slip-On | Gunn Pattern | Heavy | Men's |
| 95-809PD | Cotton / Polyester with Dotted Palm | Brown | Straight | Knit Wrist | Clute Cut | Regular | Men's |
| 95-809PDC | Cotton / Polyester with Dotted Palm | Brown | Straight | Knit Wrist | Clute Cut | Regular | Ladies' |
| 95-808 | Cotton / Polyester | Brown | Straight | Knit Wrist | Clute Cut | Regular | Men's |
| 95-806C | Cotton / Polyester | Brown | Straight | Knit Wrist | Clute Cut | Economy | Ladies' |
| 95-806 | Cotton / Polyester | Brown | Straight | Knit Wrist | Clute Cut | Economy | Men's |
| 95-606B | Cotton / Polyester | Brown | Straight | Knit Wrist | Two-Piece | Medium | Men's |
| 95-606 | Cotton / Polyester | Natural | Straight | Knit Wrist | Two-Piece | Medium | Men's |
| 95-606C | Cotton / Polyester | Natural | Straight | Knit Wrist | Two-Piece | Medium | Ladies' |

▲ [95-809](#)

GENERAL PURPOSE GLOVES

TOP GRAIN LEATHER DRIVER STYLE

TOP GRAIN LEATHER DRIVERS



◀ 68-101



- Cowhide leather construction provides comfort, durability, excellent abrasion resistance, and breathability
- Straight thumb increases comfort in close-fisted work

APPLICATIONS: *Pipe, Brick, Material Handling, Construction, Farming, General Maintenance*



◀ 70-368



- Pigskin leather becomes softer with use and withstands moisture without stiffening
- Keystone thumb is ergonomic, providing better dexterity
- Breathable for added comfort

APPLICATIONS: *Construction, Machine Operation, Utility Work, General Maintenance*



◀ 71-3618



- Goatskin leather is the most abrasion resistant leather
- Keystone thumb is ergonomic, providing better dexterity

APPLICATIONS: *Construction, Machine Operation, Utility Work, General Maintenance*

GENERAL PURPOSE GLOVES

TOP GRAIN LEATHER DRIVER STYLE

TRIED & TRUE PROTECTION



HI-VIS FINGERTIPS



◀ 68-165HV

- Cowhide leather construction provides comfort, durability, excellent abrasion resistance, and breathability
- Keystone thumb is ergonomic, providing better dexterity
- Hi-Vis color on fingertips and "Watch Your Hands" logo for visibility

APPLICATIONS: *Pipe, Brick, Material Handling, Construction, Farming, General Maintenance*



◀ 70-301

- Pigskin leather becomes softer with use and withstands moisture without stiffening
- Straight thumb increases comfort in close-fisted work
- Breathable for added comfort

APPLICATIONS: *Construction, Machine Operation, Utility Work, General Maintenance*



◀ 71-3601

- Goatskin leather is the most abrasion resistant leather
- Keystone thumb is ergonomic, providing better dexterity

APPLICATIONS: *Construction, Machine Operation, Utility Work, General Maintenance*

TOP GRAIN COWHIDE LEATHER DRIVERS

| STYLE NUMBER | HIDE | GRADE | THUMB | CUFF | CLOSURE | STITCHING | SIZE |
|--------------------------|------------------------------|----------|----------|----------|------------|-----------------|-----------|
| 68-118 | Cowhide | Premium | Straight | Slip-On | Elastic | Nylon | S - XL |
| 68-168 | Cowhide | Premium | Keystone | Slip-On | Elastic | Nylon | XS - XXL |
| 68-101 | Cowhide | Superior | Straight | Slip-On | Elastic | Nylon | XS - XXL |
| 68-158 | Cowhide | Superior | Straight | Slip-On | Pull Strap | Nylon | XS - XL |
| 68-165 | Cowhide | Superior | Keystone | Slip-On | Elastic | Nylon | S - XL |
| 68-101G | Cowhide | Superior | Straight | Gauntlet | Elastic | Nylon | L & XL |
| 68-116 | Cowhide | Superior | Wing | Slip-On | Elastic | DuPont™ Kevlar® | S - XL |
| 68-165HV | Cowhide / Hi-Vis Orange Tips | Superior | Keystone | Slip-On | Elastic | Nylon | XS - XXL |
| 68-103 | Cowhide | Regular | Straight | Slip-On | Elastic | Nylon | S - XXL |
| 68-153 | Cowhide | Regular | Straight | Slip-On | Pull Strap | Nylon | S - XL |
| 68-163 | Cowhide | Regular | Keystone | Slip-On | Elastic | Nylon | XS - XXXL |
| 68-161SB | Cowhide / Split Cowhide Back | Regular | Keystone | Slip-On | Elastic | Nylon | S - XL |
| 68-162SB | Cowhide / Split Cowhide Back | Regular | Wing | Slip-On | Elastic | DuPont™ Kevlar® | S - XL |
| 68-163SB | Cowhide / Split Cowhide Back | Regular | Keystone | Slip-On | Elastic | DuPont™ Kevlar® | S - XL |
| 68-163HV | Cowhide / Hi-Vis Orange Tips | Regular | Keystone | Slip-On | Elastic | Nylon | S - XXL |
| 68-105 | Cowhide | Economy | Straight | Slip-On | Elastic | Nylon | S - XXL |
| 68-162 | Cowhide | Economy | Keystone | Slip-On | Elastic | Nylon | S - XXL |
| 68-106 | Cowhide | Industry | Straight | Slip-On | Elastic | Nylon | S - XXL |
| 68-160SB | Cowhide / Split Cowhide Back | Industry | Keystone | Slip-On | Elastic | Nylon | S - XXL |

TOP GRAIN PIGSKIN LEATHER DRIVERS

| | | | | | | | |
|--------------------------|------------------------------|----------|----------|---------|---------|-------|----------|
| 70-318 | Pigskin | Premium | Straight | Slip-On | Elastic | Nylon | S - XL |
| 70-368 | Pigskin | Premium | Keystone | Slip-On | Elastic | Nylon | S - XL |
| 125-368 | Pigskin / Hi-Vis Orange Tips | Premium | Keystone | Slip-On | Elastic | Nylon | S - XL |
| 125-348 | Pigskin / Hi-Vis Orange Tips | Premium | Wing | Slip-On | Elastic | Nylon | S - XL |
| 70-301 | Pigskin | Economy | Straight | Slip-On | Elastic | Nylon | S - XL |
| 70-361 | Pigskin | Economy | Keystone | Slip-On | Elastic | Nylon | S - XL |
| 70-300 | Pigskin | Industry | Straight | Slip-On | Elastic | Nylon | S - XL |
| 70-360 | Pigskin | Industry | Keystone | Slip-On | Elastic | Nylon | S - XXXL |
| 70-360SB | Pigskin / Split Cowhide Back | Industry | Keystone | Slip-On | Elastic | Nylon | S - XL |

TOP GRAIN GOATSKIN LEATHER DRIVERS

| | | | | | | | |
|-------------------------|----------|----------|----------|---------|---------|-------|----------|
| 71-3618 | Goatskin | Premium | Keystone | Slip-On | Elastic | Nylon | S - XL |
| 71-3601 | Goatskin | Economy | Keystone | Slip-On | Elastic | Nylon | S - XXXL |
| 71-3600 | Goatskin | Industry | Keystone | Slip-On | Elastic | Nylon | S - XXL |

GENERAL PURPOSE GLOVES

SPLIT LEATHER DRIVER STYLE



69-189

- Keystone thumb is ergonomic, providing better dexterity

APPLICATIONS: *Construction, Machine Operation, Utility Work, Farming, General Maintenance*



69-134

- Straight thumb increases comfort in close-fisted work

APPLICATIONS: *Construction, Machine Operation, Utility Work, Farming, General Maintenance*







69-138

- Split leather provides good abrasion resistance

APPLICATIONS: *Construction, Machine Operation, Utility Work, Farming, General Maintenance*

SPLIT LEATHER DRIVERS

SPLIT LEATHER DRIVERS

| STYLE NUMBER | HIDE | GRADE | THUMB | COLOR | CUFF | STITCHING | SIZE |
|---------------|---------|---------|----------|--|---------|-----------|--------|
| 69-148 | Cowhide | Premium | Straight |  Russet | Slip-On | Nylon | S - XL |
| 69-189 | Cowhide | Premium | Keystone |  Gray | Slip-On | Nylon | S - XL |
| 69-134 | Cowhide | Regular | Straight |  Tan | Slip-On | Nylon | S - XL |
| 69-138 | Cowhide | Regular | Straight |  Brown | Slip-On | Nylon | S - XL |

GENERAL PURPOSE GLOVES

TOP GRAIN LEATHER PALM

TOP GRAIN LEATHER PALM



◀ 87-1563P

- Reinforced palm
- Cowhide leather construction provides comfort, durability, excellent abrasion resistance, and breathability

APPLICATIONS: Pipe, Brick and Other Material Handling, Construction, Farming, General Maintenance



◀ 87-3563

- Pigskin leather construction provides great breathability due to its porous texture, becomes softer with use and withstands moisture without stiffening

APPLICATIONS: Pipe, Brick and Other Material Handling, Construction, Farming, General Maintenance



◀ 87-1944

- Goatskin leather construction is the softest, most abrasion-resistant leather and is highly recommended for applications requiring tactile sensitivity

APPLICATIONS: Pipe, Brick and Other Material Handling, Construction, Farming, General Maintenance



TOP GRAIN COWHIDE LEATHER PALM

| STYLE NUMBER | HIDE | GRADE | PATTERN | PALM | BACK | COLOR | CUFF | STITCHING | SIZE |
|--------------------------|---------|---------|---------|------------|--------------|--------------------|----------|-----------------|---------|
| 87-2066 | Cowhide | Premium | Gunn | Single | Full Leather | Leather | Gauntlet | DuPont™ Kevlar® | M - XL |
| 87-1563 | Cowhide | Regular | Gunn | Single | Canvas | Blue / Black / Red | Safety | Nylon | S - XXL |
| 87-1663 | Cowhide | Regular | Gunn | Single | Canvas | Blue / Black / Red | Gauntlet | Nylon | S - XL |
| 87-1563P | Cowhide | Economy | Gunn | Reinforced | Canvas | Blue / Black / Red | Safety | Nylon | L |

TOP GRAIN PIGSKIN LEATHER PALM

| | | | | | | | | | |
|-------------------------|---------|---------|------|--------|--------|--------------------|--------|-------|--------|
| 87-3563 | Pigskin | Premium | Gunn | Single | Canvas | Blue / Black / Red | Safety | Nylon | L - XL |
| 87-3501 | Pigskin | Economy | Gunn | Single | Canvas | Blue / Black / Red | Safety | Nylon | L |

TOP GRAIN GOATSKIN LEATHER PALM

| | | | | | | | | | |
|-------------------------|----------|---------|------|--------|--------|-----|--------|-------|---|
| 87-1944 | Goatskin | Premium | Gunn | Single | Canvas | Red | Safety | Nylon | L |
|-------------------------|----------|---------|------|--------|--------|-----|--------|-------|---|

GENERAL PURPOSE GLOVES

SPLIT LEATHER PALM

LEATHER GLOVE CLASSIFICATION

PLATINUM

- Leather palm gloves constructed of heavy side-split cowhide
- Rugged extra strength back and cuff
- Stitched with Kevlar®, adding strength and heat resistance

GOLD

- Leather palm gloves constructed of Grade A select shoulder-split cowhide
- Excellent quality and very affordable

SILVER

- Leather palm gloves constructed of Grade A/B shoulder-split cowhide
- Best value grade of leather palms

BRONZE

- Leather palm gloves constructed of Grade B shoulder-split cowhide
- High quality and outstanding value
- Size large is sized larger than most competitive gloves

COPPER

- Leather palm gloves constructed of Grade B/C split cowhide
- Consistent quality at an affordable price
- Cotton color binding denotes sizes

ECONOMY

- Leather palm gloves constructed of the most economical split cowhide available in the market today

SPLIT LEATHER PALM



STITCHED WITH KEVLAR®



80-8844

- Constructed of heavy side-split cowhide
- Cotton lined palm for extra comfort
- Wing thumb increases comfort in open-handed work
- Gunn cut pattern delivers excellent durability, wear and comfort

APPLICATIONS: *Construction, Road Work, Excavation, General Maintenance*



COTTON LINED PALM



82-7663

- Constructed of Grade A/B shoulder-split cowhide
- Gunn cut pattern delivers excellent durability, wear and comfort
- Fabric back provides breathability and flexibility
- Leather knuckle strap and finger tips for extra protection

APPLICATIONS: *Construction, Road Work, Excavation, General Maintenance*



COTTON LINED PALM



83-6563

- Wing thumb increases comfort in open-handed work
- Leather knuckle strap and fingertips provide additional protection
- Safety cuff helps protect wrist and allows for fast removal

APPLICATIONS: *Construction, Road Work, Excavation, General Maintenance*

GENERAL PURPOSE GLOVES

SPLIT LEATHER PALM



80-8846

- Constructed of heavy side-split cowhide
- Cotton lined palm for extra comfort
- Wing thumb increases comfort in open-handed work
- Gunn cut pattern delivers excellent durability, wear and comfort

APPLICATIONS: *Construction, Road Work, Excavation, General Maintenance*



81-7563YB

- Cowhide leather construction provides comfort, durability, excellent abrasion resistance, and breathability
- Wing thumb increases comfort in open-handed work
- Leather knuckle strap and finger tips for extra protection

APPLICATIONS: *Construction, Road Work, Excavation, General Maintenance*



125-7563

- Shoulder-split cowhide leather construction provides comfort, durability, excellent abrasion resistance, and breathability
- Leather palm and finger tips for extra protection
- Wing thumb increases comfort in open-handed work
- Gunn cut pattern delivers excellent durability, wear and comfort

APPLICATIONS: *Outdoor, General Work, Highway Construction*



SPLIT LEATHER PALM

| STYLE NUMBER | HIDE | SERIES | GRADE | PATTERN | PALM | BACK | COLOR | CUFF | STITCHING | SIZE |
|--------------------|---------|----------|---------------------|---------|--------|-------------------|-----------------|-----------------------|-----------------|------------|
| 80-8800 | Cowhide | Platinum | Heavy Side | Gunn | Single | Heavy Canvas | ■ White | Safety, Rubberized | DuPont™ Kevlar® | S - XL |
| 80-8889 | Cowhide | Platinum | Heavy Side | Gunn | Single | Canvas | ■ White | Safety, Launderable | DuPont™ Kevlar® | S - XL |
| 80-8844 | Cowhide | Platinum | Heavy Side | Gunn | Single | Leather | ■ Leather | Safety, Rubberized | DuPont™ Kevlar® | S - XL |
| 80-8846 | Cowhide | Platinum | Heavy Side | Gunn | Single | Leather | ■ Leather | Gauntlet, Rubberized | DuPont™ Kevlar® | L - XL |
| 81-7563YB | Cowhide | Gold | A Select Shoulder | Gunn | Single | Heavy Canvas | ■ Gold | Safety, Rubberized | Nylon | L |
| 82-7563 | Cowhide | Silver | A/B Select Shoulder | Gunn | Single | Canvas | ■ Blue / Green | Safety, Rubberized | Nylon | S - XL |
| 82-7583 | Cowhide | Silver | A/B Select Shoulder | Gunn | Single | Canvas | ■ White | Safety, Rubberized | Nylon | S - XL |
| 125-7563 | Cowhide | Silver | Select Shoulder | Gunn | Single | Canvas | ■ Hi-Vis Orange | Safety, Rubberized | Nylon | L |
| 82-7663 | Cowhide | Silver | A/B Select Shoulder | Gunn | Single | Canvas | ■ Blue / Green | Gauntlet, Rubberized | Nylon | M - XL |
| 82-5044 | Cowhide | Silver | A/B Select Shoulder | Gunn | Single | Leather | ■ Leather | Safety, Rubberized | Nylon | L |
| 82-5066 | Cowhide | Silver | A/B Select Shoulder | Gunn | Single | Leather | ■ Leather | Gauntlet, Rubberized | Nylon | S - XL |
| 86-4244 | Cowhide | Bronze | Regular | Gunn | Single | Canvas | ■ Green / Pink | Knit Wrist | Nylon | Men's |
| 83-6563 | Cowhide | Bronze | B Shoulder | Gunn | Single | Canvas | ■ Green / Pink | Safety, Rubberized | Nylon | XS - XXL |
| 83-6563/LHO | Cowhide | Bronze | B Shoulder | Gunn | Single | Canvas | ■ Green / Pink | Safety, Rubberized | Nylon | S - L |
| 83-6563/RHO | Cowhide | Bronze | B Shoulder | Gunn | Single | Canvas | ■ Green / Pink | Safety, Rubberized | Nylon | S - L |
| 83-6663 | Cowhide | Bronze | B Shoulder | Gunn | Single | Canvas | ■ Green / Pink | Gauntlet, Rubberized | Nylon | XS - XL |
| 82-7683D | Cowhide | Bronze | B Shoulder | Gunn | Single | Heavy Canvas | ■ White | Gauntlet, Launderable | Nylon | S, L & XXL |
| 83-6033 | Cowhide | Bronze | B Shoulder | Gunn | Single | Canvas, ¾ Leather | ■ Green / Pink | Gauntlet | Nylon | L |
| 86-6044 | Cowhide | Bronze | B Shoulder | Gunn | Single | Leather | ■ Leather | Safety, Rubberized | Nylon | L |

GENERAL PURPOSE GLOVES

SPLIT LEATHER PALM & DOUBLE LEATHER PALM



84-7532

- Wing thumb increases comfort in open-handed work
- Fabric back provides breathability and flexibility
- Leather knuckle strap and finger tips for extra protection

APPLICATIONS: *Construction, Road Work, Excavation, General Maintenance*



85-7513P

- Wing thumb increases comfort in open-handed work
- Fabric back provides breathability and flexibility
- Leather knuckle strap and finger tips for extra protection

APPLICATIONS: *Construction, Road Work, Excavation, General Maintenance*

RUBBERIZED SAFETY CUFF



84-7533

- Constructed of B/C grade shoulder-split cowhide
- Double palm offers comfort, insulation and heat protection
- Fabric back provides breathability and flexibility
- Leather knuckle strap and finger tips for extra protection

APPLICATIONS: *Construction, Road Work, Excavation, General Maintenance*

SPLIT LEATHER PALM

| STYLE NUMBER | HIDE | SERIES | GRADE | CONSTRUCTION | PALM | BACK | COLOR | CUFF | STITCHING | SIZE |
|----------------------------|---------|---------|--------------|--------------|------------|--------|--------------------|----------------------|-----------|--------------|
| 84-7532 | Cowhide | Copper | B/C Shoulder | Gunn | Single | Canvas | Blue / Black / Red | Safety, Rubberized | Nylon | S - XL |
| 84-6532 | Cowhide | Copper | B/C Shoulder | Gunn | Single | Canvas | Green / Pink | Safety, Rubberized | Nylon | L |
| 85-7512 | Cowhide | Copper | B/C Shoulder | Gunn | Single | Canvas | Gray / Red | Safety, Rubberized | Nylon | Men's |
| 85-7512C | Cowhide | Copper | B/C Shoulder | Gunn | Single | Canvas | Gray / Red | Safety, Rubberized | Nylon | Ladies' |
| 84-7532A | Cowhide | Copper | B/C Shoulder | Gunn | Single | Canvas | Blue / Green | Safety, Launderable | Nylon | XS, S, L, XL |
| 85-7512CS | Cowhide | Copper | B/C Shoulder | Gunn | Single | Canvas | Gray / Red | Safety, Starched | Nylon | Ladies' |
| 84-7632 | Cowhide | Copper | B/C Shoulder | Gunn | Single | Canvas | Blue / Black / Red | Gauntlet, Rubberized | Nylon | S - XL |
| 86-4144 | Cowhide | Economy | Regular | Gunn | Single | Canvas | Blue / Black / Red | Knit Wrist | Nylon | Men's |
| 86-4104 | Cowhide | Economy | Regular | Clute | Single | Canvas | Blue / Black / Red | Knit Wrist | Nylon | Men's |
| 86-4104C | Cowhide | Economy | Regular | Clute | Single | Canvas | Blue / Black / Red | Knit Wrist | Nylon | Ladies' |
| 86-4104P | Cowhide | Economy | Economy | Clute | Reinforced | Canvas | Blue / Black / Red | Knit Wrist | Nylon | Men's |
| 85-7513P | Cowhide | Economy | Economy | Gunn | Reinforced | Canvas | Yellow | Safety, Rubberized | Nylon | Men's |
| 85-7500 | Cowhide | Economy | Economy | Gunn | Single | Canvas | Blue / Black / Red | Safety, Rubberized | Nylon | S - XL |
| 85-7500S | Cowhide | Economy | Economy | Gunn | Single | Canvas | Blue / Black / Red | Safety, Starched | Nylon | Men's |
| 85-7500P | Cowhide | Economy | Economy | Gunn | Reinforced | Canvas | Blue / Black / Red | Safety, Starched | Nylon | Men's |
| 85-DB7563 | Cowhide | Economy | Economy | Gunn | Single | Denim | Blue | Safety, Denim | Nylon | Men's |
| 85-DB7563P | Cowhide | Economy | Economy | Gunn | Reinforced | Denim | Blue | Safety, Denim | Nylon | Men's |
| 85-7612S | Cowhide | Economy | Economy | Gunn | Single | Canvas | Gray / Red | Gauntlet, Starched | Nylon | Men's |

SPLIT LEATHER DOUBLE PALM

| | | | | | | | | | | |
|---------------------------|---------|----------|---------------------|------|--------|--------------|--------------------|----------------------|-----------------|--------|
| 80-8855 | Cowhide | Platinum | Heavy Side | Gunn | Double | Heavy Canvas | White | Safety, Rubberized | DuPont™ Kevlar® | S - XL |
| 80-8866 | Cowhide | Platinum | Heavy Side | Gunn | Double | Heavy Canvas | White | Gauntlet, Rubberized | DuPont™ Kevlar® | XL |
| 82-7763 | Cowhide | Silver | A/B Select Shoulder | Gunn | Double | Canvas | Blue / Green | Safety, Rubberized | Nylon | S - XL |
| 82-7563ID | Cowhide | Silver | A/B Select Shoulder | Gunn | Double | Canvas | Blue / Green | Safety, Rubberized | Nylon | L |
| 83-6733 | Cowhide | Bronze | B Shoulder | Gunn | Double | Canvas | Green / Pink | Safety, Rubberized | Nylon | L |
| 83-6763 | Cowhide | Bronze | B Shoulder | Gunn | Double | Canvas | Green / Pink | Gauntlet, Rubberized | Nylon | L |
| 84-7533J | Cowhide | Bronze | B/C Shoulder | Gunn | Double | Canvas | Blue / Black / Red | Safety, Rubberized | Nylon | L |
| 84-7533 | Cowhide | Copper | B/C Shoulder | Gunn | Double | Canvas | Blue / Black / Red | Safety, Rubberized | Nylon | L |
| 84-7633 | Cowhide | Copper | B/C Shoulder | Gunn | Double | Canvas | Blue / Black / Red | Gauntlet, Rubberized | Nylon | L |
| 85-7512J | Cowhide | Economy | B/C Shoulder | Gunn | Double | Canvas | Gray / Red | Safety, Rubberized | Nylon | S - XL |

CHEMICAL RESISTANT GLOVES

POLYMER TECHNOLOGY

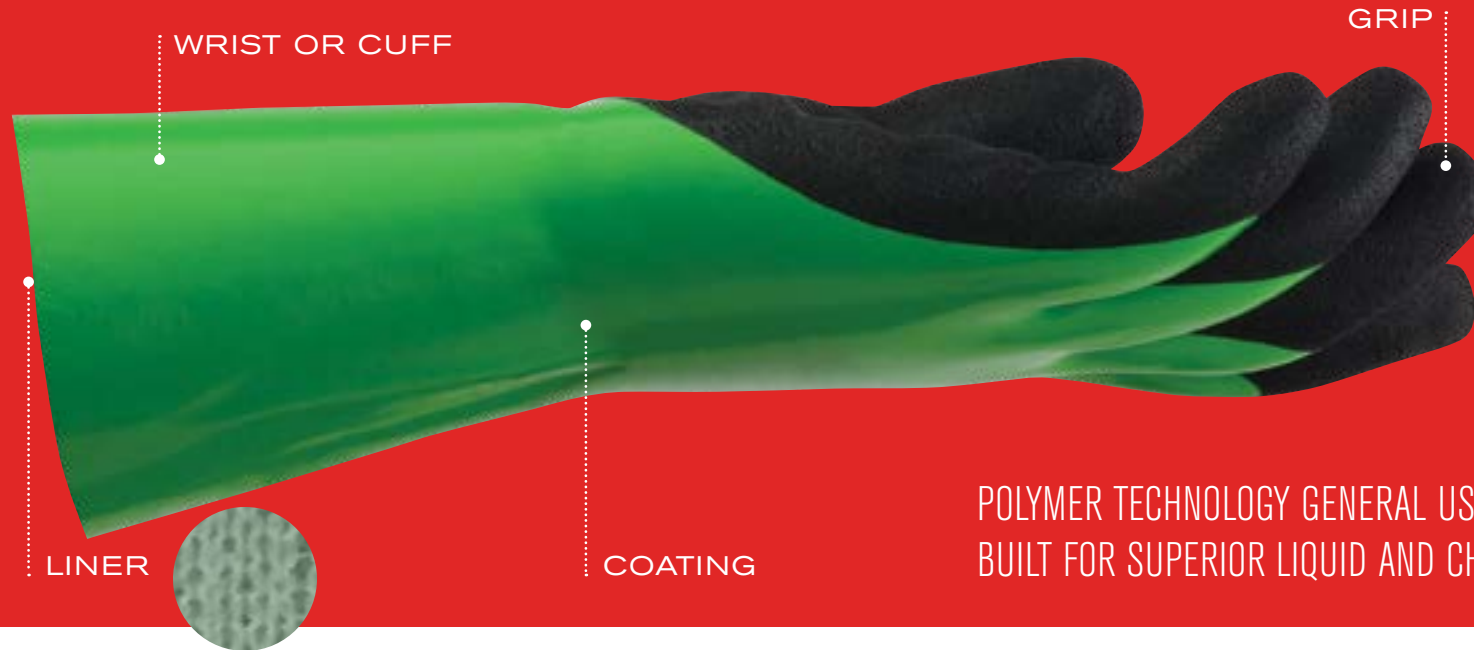

DESIGN FACTORS:

- Supported (liner) for added puncture resistance, durability and comfort
- Unsupported (no liner) for dexterity, hygiene and cleanliness
- Thickness of polymer alone or polymer/liner
- Wrist length and shape
- Coating variants range from ¾-dipped to fully coated
- Coating textured for enhanced grip

POLYMER TECHNOLOGY GENERAL USE GLOVES,
BUILT FOR SUPERIOR LIQUID AND CHEMICAL RESISTANCE

POLYMER TECHNOLOGY GLOVES MAY BE SUPPORTED OR UNSUPPORTED.

- **Supported** gloves are made by dipping a knit or woven cloth liner into a liquid polymer for coating. The liner "supports" the coating and adds strength.
- **Unsupported** gloves are made on hand formers that are dipped directly into a liquid polymer compound and stripped off when cured.

POLYMER MATERIALS



LATEX

ADVANTAGE

- Good resistance to numerous acids and ketones
- Flexible, tear and snag resistant

PRECAUTION

- Avoid contact with hydrocarbon based oils or solvents
- Latex intolerance with some users



NITRILE

ADVANTAGE

- Good resistance to hydrocarbon derivatives
- Tough and resistant to abrasion, snags and perforation

PRECAUTION

- Smooth finish not recommended in oily conditions



NEOPRENE

ADVANTAGE

- Broad range resistance to acids, alcohols, fats, caustics, refrigerant, ketones and detergents
- Tough and resistant to abrasion, snags and perforation

PRECAUTION

- Degrades with some common chemicals such as bleach



PVC

ADVANTAGE

- Resists diluted aqueous solutions of bases or acids
- Reliable resistance to oils and organic solvents

PRECAUTION

- Less flexible, tacky and susceptible to snagging

CHEMICAL RESISTANT GLOVES

UNSUPPORTED LATEX

Assurance[®]
HAND PROTECTION

UNSUPPORTED

LATEX

FOR GENERAL MAINTENANCE APPLICATIONS

CHEMICAL RESISTANT GLOVES

UNSUPPORTED LATEX



STRAIGHT CUFF



ASSURANCE® 47-L170Y

- Raised diamond pattern for enhanced grip in wet or dry conditions
- Made with component materials that comply with federal regulations for food contact 21 CFR 170-199
- CFIA approved

APPLICATIONS: *Food Processing, Janitorial, Maintenance, Poultry*



PINKED CUFF



ASSURANCE® 48-L185B

- Honeycomb pattern for enhanced grip
- Made from component materials that comply with Federal Regulations for food contact 21 CFR, 170-199
- Flock lining provides easy on and off, plus moisture absorption
- Pinked cuff for tear resistance

APPLICATIONS: *Janitorial, Maintenance, Sanitation*



ROLLED CUFF

ASSURANCE® 47-L210T

- Roughened sandblast pattern for enhanced grip in wet conditions
- Longer cuff for additional forearm protection
- Made with component materials that comply with federal regulations for food contact 21 CFR 170-199

APPLICATIONS: *Janitorial, Maintenance, Diluted Acids and Caustic Solutions*

ASSURANCE® UNLINED LATEX

| STYLE NUMBER | EN 374 | 21CFR | CFIA | POLYMER | COLOR | THICKNESS | CUFF | LENGTH | CONSTRUCTION | GRIP PATTERN | LINING | SIZES |
|--------------------------|--------|-------|------|---------|---------|-----------|----------|--------|--------------|---------------------|---------|--------|
| 47-L170Y | ABK | Yes | Yes | Latex | Yellow | 18 mil | Rolled | 12" | Unsupported | Raised Diamond | Unlined | S - XL |
| 47-L171B | ABK | Yes | Yes | Latex | Blue | 18 mil | Straight | 12" | Unsupported | Raised Diamond | Unlined | S - XL |
| 47-L171N | ABK | Yes | Yes | Latex | Natural | 18 mil | Straight | 12" | Unsupported | Raised Diamond | Unlined | S - XL |
| 47-L161N | --- | Yes | Yes | Latex | Natural | 16 mil | Rolled | 12" | Unsupported | Raised Diamond | Unlined | S - XL |
| 47-L161B | --- | Yes | Yes | Latex | Blue | 16 mil | Rolled | 12" | Unsupported | Raised Diamond | Unlined | S - XL |
| 47-L210T | --- | No | No | Latex | Orange | 18 mil | Rolled | 15" | Unsupported | Roughened Sandblast | Unlined | S - XL |
| 47-L442 | AKL | No | No | Latex | Black | 44 mil | Rolled | 17" | Unsupported | Smooth | Unlined | M - XL |

ASSURANCE® FLOCK LINED LATEX

| | | | | | | | | | | | | |
|---------------------------|-----|-----|-----|-------|--------|--------|----------|-----|-------------|----------------|---------|---------|
| 48-L140Y | --- | Yes | Yes | Latex | Yellow | 14 mil | Rolled | 12" | Unsupported | Honeycomb | Flocked | S - XL |
| 48-L160Y | --- | Yes | Yes | Latex | Yellow | 16 mil | Straight | 12" | Unsupported | Honeycomb | Flocked | S - XXL |
| 48-L162Y* | --- | Yes | Yes | Latex | Yellow | 16 mil | Straight | 12" | Unsupported | Honeycomb | Flocked | S - XL |
| 48-L185B | AKL | Yes | Yes | Latex | Blue | 18 mil | Pinked | 12" | Unsupported | Honeycomb | Flocked | S - XL |
| 48-L185P | AKL | Yes | Yes | Latex | Pink | 18 mil | Pinked | 12" | Unsupported | Honeycomb | Flocked | S - XL |
| 48-L185T | --- | No | Yes | Latex | Orange | 18 mil | Rolled | 12" | Unsupported | Honeycomb | Flocked | S - XL |
| 48-L185Y* | AKL | Yes | Yes | Latex | Yellow | 18 mil | Rolled | 12" | Unsupported | Honeycomb | Flocked | S - XL |
| 48-L187Y* | AKL | Yes | No | Latex | Yellow | 18 mil | Rolled | 12" | Unsupported | Honeycomb | Flocked | S - XL |
| 48-L212Y* | ABK | Yes | Yes | Latex | Yellow | 21 mil | Rolled | 12" | Unsupported | Raised Diamond | Flocked | S - XL |
| 48-L2125Y | --- | Yes | Yes | Latex | Yellow | 20 mil | Rolled | 15" | Unsupported | Super Diamond | Flocked | S - XXL |
| 48-L300K | --- | Yes | No | Latex | Black | 28 mil | Rolled | 12" | Unsupported | Super Diamond | Flocked | M - XXL |
| 48-L302T* | --- | No | No | Latex | Orange | 28 mil | Rolled | 12" | Unsupported | Super Diamond | Flocked | S - XL |

ASSURANCE® SUPPORTED LATEX

| | | | | | | | | | | | | |
|-------------------------|-----|----|----|-------|------|-----|----------|-----|-----------|---------|-------|---------|
| 55-1635 | --- | No | No | Latex | Blue | --- | Straight | 12" | Supported | Crinkle | Nylon | S - XXL |
|-------------------------|-----|----|----|-------|------|-----|----------|-----|-----------|---------|-------|---------|

* Pair Packed

CHEMICAL RESISTANT GLOVES

UNSUPPORTED NITRILE

UNSUPPORTED NITRILE



EN 374



AJKL

ASSURANCE®

50-N092B

- Lightweight to offer high dexterity and sensitivity
- Raised diamond pattern for enhanced grip in wet or dry conditions
- CFIA approved

APPLICATIONS: Chemical Processing, Oil Refining and Petrochemicals, Food Processing, Aerospace, Automotive Assembly and Painting, Machine Operations, Metal Fabrication, Graphic Arts and Printing Cleanup, Furniture Manufacturing, Electronics

Assurance®
HAND PROTECTION

ASSURANCE® UNLINED NITRILE

| STYLE NUMBER | EN 374 | 21 CFR | CFIA | POLYMER | COLOR | THICKNESS | CUFF | LENGTH | CONSTRUCTION | GRIP PATTERN | LINING | SIZES |
|------------------|--------|--------|------|---------|-------|-----------|----------|--------|--------------|----------------|---------|---------|
| 50-N092B | AJKL | Yes | Yes | Nitrile | Blue | 8 mil | Straight | 13" | Unsupported | Raised Diamond | Unlined | S - XXL |
| 50-NKH11 | BFGHJ | Yes | No | Nitrile | Blue | 11 mil | Straight | 13" | Unsupported | Smooth | Unlined | S - XXL |
| 50-N110G | ABK | Yes | Yes | Nitrile | Green | 11 mil | Straight | 13" | Unsupported | Raised Diamond | Unlined | S - XXL |
| 50-N115G | --- | Yes | Yes | Nitrile | Green | 11 mil | Straight | 13" | Unsupported | Super Diamond | Unlined | M - XXL |
| 50-N140B | AJK | Yes | Yes | Nitrile | Blue | 15 mil | Straight | 13" | Unsupported | Raised Diamond | Unlined | S - XXL |
| 50-N140G | AJK | Yes | Yes | Nitrile | Green | 15 mil | Straight | 13" | Unsupported | Raised Diamond | Unlined | S - XXL |
| 50-N2250G | AKL | Yes | Yes | Nitrile | Green | 22 mil | Straight | 15" | Unsupported | Raised Diamond | Unlined | M - XXL |
| 50-N2272G | AKJ | Yes | Yes | Nitrile | Green | 22 mil | Straight | 18" | Unsupported | Sandpatch | Unlined | M - XXL |

ASSURANCE® FLOCK LINED NITRILE

| | | | | | | | | | | | | |
|-----------------|------|-----|-----|---------|-------|--------|----------|-----|-------------|----------------|---------|----------|
| 50-N150G | AJKL | Yes | No | Nitrile | Green | 15 mil | Straight | 13" | Unsupported | Raised Diamond | Flocked | S - XXL |
| 50-N160G | AJK | Yes | Yes | Nitrile | Green | 15 mil | Straight | 13" | Unsupported | Raised Diamond | Flocked | XS - XXL |
| 50-N160B | AJK | Yes | Yes | Nitrile | Blue | 15 mil | Straight | 13" | Unsupported | Raised Diamond | Flocked | XS - XXL |

PROTECTS FROM SOLVENTS & OIL BASED CHEMICALS

CHEMICAL RESISTANT GLOVES

UNSUPPORTED NEOPRENE

PROTECTS FROM ACIDS, CAUSTICS, SOLVENTS & OILS

UNSUPPORTED NEOPRENE

EN 374



AKL

ASSURANCE® 52-3670

- Heavyweight for enhanced protection
- Raised diamond pattern provides added grip on wet or dry surfaces
- Double-dipped glove provides the chemical resistance of neoprene with the comfort of latex

APPLICATIONS: *Petrochemical Industry, Battery Manufacturing, Janitorial, Aircraft Industry, Automotive, General Maintenance and Photo Finishing*



ASSURANCE® NEOPRENE FLOCK LINED CANNERS

| STYLE NUMBER | EN 374 | 21CFR | CFIA | POLYMER | COLOR | THICKNESS | CUFF | LENGTH | CONSTRUCTION | GRIP PATTERN | LINING | SIZES |
|-------------------------|--------|-------|------|---------------------|-----------------|-----------|----------|--------|--------------|----------------|---------|---------|
| 52-3665 | AKL | Yes | No | Neoprene | ☐ Black | 28 mil | Straight | 12" | Unsupported | Raised Diamond | Flocked | S - XL |
| 52-3672 | --- | Yes | No | Neoprene Over Latex | ▣ Blue / Yellow | 19 mil | Straight | 12" | Unsupported | Raised Diamond | Flocked | S - XL |
| 52-3670 | AKL | Yes | No | Neoprene Over Latex | ▣ Blue / Yellow | 28 mil | Straight | 12" | Unsupported | Raised Diamond | Flocked | S - XXL |
| 52-3671 | AKL | Yes | No | Neoprene Over Latex | ▣ Blue / Yellow | 28 mil | Straight | 12" | Unsupported | Honeycomb | Flocked | S - XL |

CHEMICAL RESISTANT GLOVES

SUPPORTED BLENDED POLYMER



MAXICHEM[®]

ADVANCED PROTECTION

CHEMICAL RESISTANT GLOVES

SUPPORTED BLENDED POLYMER

DESIGNED & DEVELOPED FOR THOSE WORKING WITH CHEMICALS, WHO REQUIRE HIGHER LEVELS OF PROTECTION.



▲ 56-630

▲ 56-633

▲ 56-635



MAXICHEM®

- Lightweight design provides high dexterity and sensitivity
- Micro-cup non-slip grip provides superior grip in wet and oily conditions
- Tailored cuff enhances fit for superior control

APPLICATIONS: *Gearbox Assembly, General Handling, Handling Small Castings, Handling of Small Components, Light Metal Fabrication, Parts Handling, Maintenance*

MAXICHEM®

| STYLE NUMBER | EN 374 | EN 388 | CFIA | POLYMER | POLYMER COLOR | GRIP COLOR | COATING COVERAGE | CUFF | LENGTH | CONSTRUCTION | GRIP PATTERN | LINING | SIZES |
|--------------|--------|--------|------|---------|---------------|------------|------------------|----------|--------|--------------|--------------|-----------------|---------|
| 56-630 | AKL | 4121 | Yes | Nitrile | Green | Black | Full | Gauntlet | 12" | Supported | Non-Slip | Nylon | S - XXL |
| 56-633 | AKL | 4342 | No | Nitrile | Green | Black | Full | Gauntlet | 12" | Supported | Non-Slip | Engineered Yarn | S - XXL |
| 56-635 | AKL | 4121 | Yes | Nitrile | Green | Black | Full | Gauntlet | 14" | Supported | Non-Slip | Nylon | S - XXL |

PROVIDES COMFORT AND FLEXIBILITY ALONG WITH MAXIMUM FINGERTIP TACTILE SENSITIVITY NOT FOUND IN OTHER CHEMICAL RESISTANT PRODUCTS

BLENDED POLYMER ON ULTRA FINE GAUGE SEAMLESS KNIT NYLON LINER

EXCLUSIVE GRIPTECH® COATING OFFERS NON-SLIP CAPABILITIES

LIQUITECH® BARRIER TECHNOLOGY PROVIDES RESISTANCE TO OILS AND LIQUIDS



LIQUID RESISTANT GLOVES

COATED SUPPORTED STYLES

LIQUID PROTECTION

PROCOAT®

GREAT FOR OILY & WET CONDITIONS



58-8030Y

- Single-dipped construction
- Jersey liner provides better comfort
- Yellow color allows for glove degradation to be easily identified

APPLICATIONS: *Mining, Construction, Refining, Petrochemicals & Handling Oily Materials*



58-8015R

- Single-dipped construction
- Semi-rough finish provides better grip in wet conditions
- Interlock lining dries quickly and offers better dexterity

APPLICATIONS: *Mining, Construction, Refining, Petrochemicals & Handling Oily Materials*



58-8414R

- Double-dipped coating for superior liquid protection and extended wear
- Sandy finish provides better grip in wet conditions
- Jersey liner provides better comfort
- Longer cuff for additional forearm protection

APPLICATIONS: *Mining, Construction, Refining, Petrochemicals & Handling Oily Materials*

LONGER CUFF

LIQUID RESISTANT GLOVES

COATED SUPPORTED STYLES



58-8120DD

- Double-dipped coating for superior liquid protection and extended wear
- Sandy finish provides better grip in wet conditions
- Interlock lining dries quickly and offers better dexterity

APPLICATIONS: Mining, Construction, Refining, Petrochemicals & Handling Oily Materials



58-8035DD

- Double-dipped coating for superior liquid protection and extended wear
- Coating provides better grip in wet conditions
- Jersey liner provides better comfort

APPLICATIONS: Mining, Construction, Refining, Petrochemicals & Handling Oily Materials



58-8658K

- Kevlar® liner provides cut and light heat protection
- Seamless knit construction for enhanced dexterity and comfort
- Oil and liquid resistant

APPLICATIONS: Mining, Construction, Refining, Petrochemicals & Handling Oily Materials

KEVLAR® LINED

PROCOAT® GP - PVC DIPPED GLOVES

| STYLE NUMBER | EN 388 | POLYMER | COLOR | CUFF | LENGTH | CONSTRUCTION | GRIP PATTERN | LINING | SIZES |
|------------------|--------|---------|--------|------------|--------|--------------------------|--------------|-----------|-------|
| 58-8015 | 4121 | PVC | Black | Knit Wrist | 10" | Supported, Single-Dipped | Smooth* | Interlock | Men's |
| 58-8020 | 4121 | PVC | Black | Straight | 10" | Supported, Single-Dipped | Smooth* | Interlock | Men's |
| 58-8030 | 4121 | PVC | Black | Straight | 12" | Supported, Single-Dipped | Smooth* | Interlock | Men's |
| 58-8040 | 4121 | PVC | Black | Straight | 14" | Supported, Single-Dipped | Smooth* | Interlock | Men's |
| 58-8060 | 4121 | PVC | Black | Straight | 18" | Supported, Single-Dipped | Smooth* | Interlock | Men's |
| 58-8030Y | 4121 | PVC | Yellow | Straight | 12" | Supported, Single-Dipped | Smooth* | Jersey | Men's |
| 58-8040Y | 4121 | PVC | Yellow | Straight | 14" | Supported, Single-Dipped | Smooth* | Jersey | Men's |
| 58-8015R | 4121 | PVC | Black | Knit Wrist | 10" | Supported, Single-Dipped | Semi-Rough | Interlock | Men's |
| 58-8020R | 4121 | PVC | Black | Straight | 10" | Supported, Single-Dipped | Semi-Rough | Interlock | Men's |
| 58-8030R | 4121 | PVC | Black | Straight | 12" | Supported, Single-Dipped | Semi-Rough | Interlock | Men's |
| 58-8040R | 4121 | PVC | Black | Straight | 14" | Supported, Single-Dipped | Semi-Rough | Interlock | Men's |
| 58-8015DD | 4121 | PVC | Black | Knit Wrist | 10" | Supported, Double-Dipped | Rough Acid | Jersey | Men's |
| 58-8020DD | 4121 | PVC | Black | Straight | 10" | Supported, Double-Dipped | Rough Acid | Jersey | Men's |
| 58-8030DD | 4121 | PVC | Black | Straight | 12" | Supported, Double-Dipped | Rough Acid | Jersey | Men's |
| 58-8025DD | 4121 | PVC | Green | Straight | 12" | Supported, Double-Dipped | Rough Acid | Jersey | Men's |
| 58-8035DD | 4121 | PVC | Green | Straight | 14" | Supported, Double-Dipped | Rough Acid | Jersey | Men's |
| 58-8040DD | 4121 | PVC | Black | Straight | 14" | Supported, Double-Dipped | Rough Acid | Jersey | Men's |
| 58-8115DD | --- | PVC | Black | Knit Wrist | 10" | Supported, Double-Dipped | Sandy | Interlock | Men's |
| 58-8120DD | 4121 | PVC | Black | Straight | 10" | Supported, Double-Dipped | Sandy | Interlock | Men's |
| 58-8130DD | 4121 | PVC | Black | Straight | 12" | Supported, Double-Dipped | Sandy | Interlock | Men's |
| 58-8140DD | 4121 | PVC | Black | Straight | 14" | Supported, Double-Dipped | Sandy | Interlock | Men's |
| 58-8215DD | --- | PVC | Black | Knit Wrist | 10" | Supported, Double-Dipped | Sandy | Jersey | Men's |
| 58-8230DD | --- | PVC | Black | Straight | 12" | Supported, Double-Dipped | Sandy | Jersey | Men's |
| 58-8240DD | --- | PVC | Black | Straight | 14" | Supported, Double-Dipped | Sandy | Jersey | Men's |
| 58-8362 | 4121 | PVC | Black | Straight | 12" | Supported, Double-Dipped | Sandy | Jersey | Men's |
| 58-8364 | 4121 | PVC | Black | Straight | 14" | Supported, Double-Dipped | Sandy | Jersey | Men's |
| 58-8431R | 4121 | PVC | Red | Straight | 24" | Supported, Double-Dipped | Sandy | Interlock | Men's |
| 58-8414R | --- | PVC | Red | Straight | 14" | Supported, Double-Dipped | Sandy | Jersey | Men's |

XTRATUFF™

| STYLE NUMBER | EN 374 | ANSI | EN 388 | POLYMER | COLOR | CUFF | LENGTH | CONSTRUCTION | GRIP PATTERN | LINING | SIZES |
|-----------------|--------|------|--------|---------|-------|----------|--------|--------------|--------------|---------|--------|
| 58-8658K | AJK | A3 | 4342 | PVC | Blue | Straight | 12" | Supported | Rough | Kevlar® | M - XL |

*Not recommended for oily conditions

LIQUID RESISTANT GLOVES

SUPPORTED PVC



◀ 58-7303

- Liquid-proof
- Foam insulated to keep hands warm and dry
- Hi-Vis for enhanced hand visibility

APPLICATIONS: *Handling Grease, Oils, Acids, Caustics, Solvents, Highway Construction, Traffic Control*

CHEMICAL PROTECTION FOR COLD ENVIRONMENTS



◀ 58-8658DL

- Liquid-proof
- Seamless knit construction for enhanced dexterity and comfort
- Cold-resistant outer shell
- Sandy finish provides better grip in wet conditions
- Foam insulated to keep hands warm and dry

APPLICATIONS: *Handling Grease, Oils, Acids, Caustics, Solvents*

REMOVABLE LINER

PROCOAT® INSULATED PVC DIPPED GLOVE

| STYLE NUMBER | EN 374 | EN 388 | POLYMER | COLOR | CUFF | LENGTH | CONSTRUCTION | GRIP | LINING | SIZES |
|------------------|--------|--------|---------|---------------|------------|--------|--------------|---------|-------------------|--------|
| 58-7303 | --- | --- | PVC | Hi-Vis Orange | Knit Wrist | 11" | Supported | Smooth | Foam | Men's |
| 58-7304 | --- | --- | PVC | Hi-Vis Orange | Straight | 12" | Supported | Smooth | Foam | Men's |
| 58-7305 | --- | --- | PVC | Hi-Vis Orange | Safety | 10" | Supported | Smooth | Foam | Men's |
| 58-7313 | --- | --- | PVC | Hi-Vis Orange | Knit Wrist | 11" | Supported | Crystal | Foam | Men's |
| 58-7315 | --- | --- | PVC | Hi-Vis Orange | Safety | 10" | Supported | Crystal | Foam | Men's |
| 58-8658DL | AJK | 4121 | PVC | Blue | Straight | 12" | Supported | Rough | Interlock / Terry | L - XL |

SPECIALTY PVC BLENDS

| | | | | | | | | | | |
|----------------|-----|------|-----|-------|----------|-----|-----------|-------|-----------|--------|
| 58-8650 | --- | 4121 | PVC | Brown | Straight | 10" | Supported | Rough | Interlock | S - XL |
| 58-8651 | --- | 4121 | PVC | Brown | Straight | 12" | Supported | Rough | Interlock | S - XL |

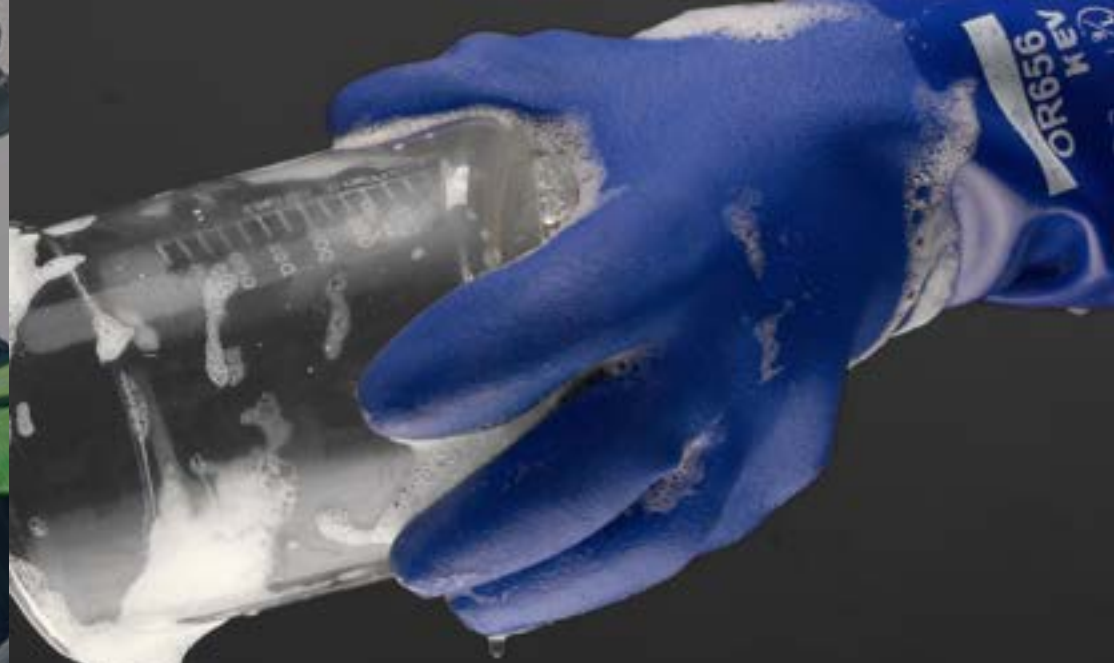

OILY & WET CONDITIONS



◀ 58-8655

- Special PVC blend that stays soft and flexible in oily applications
- Rough coated palm for enhanced grip
- Seamless liner provides tactile sensitivity
- Treated to resist germs and odors

APPLICATIONS: *Machine Oil, Petrochemicals, Maintenance, Landscaping*



▲ 58-8656

SPECIALTY PVC BLENDS

| STYLE NUMBER | EN 374 | EN 388 | POLYMER | COLOR | CUFF | LENGTH | CONSTRUCTION | GRIP | LINING | SIZES |
|----------------|--------|--------|---------|-------|----------|--------|--------------|-------|-----------|---------|
| 58-8655 | --- | 4121 | PVC | Blue | Straight | 10" | Supported | Rough | Interlock | S - XL |
| 58-8656 | --- | 4121 | PVC | Blue | Straight | 12" | Supported | Rough | Interlock | S - XXL |
| 58-8657 | AJK | 4121 | PVC | Blue | Straight | 25" | Supported | Rough | Interlock | M - XL |

LIQUID & CHEMICAL RESISTANT GLOVES

SUPPORTED NEOPRENE & NITRILE COATED

ACTIVGRIP™ NITRILE COATED GLOVE

| STYLE NUMBER | EN 388 | POLYMER | COLOR | CUFF | LENGTH | CONSTRUCTION | GRIP | LINING | SIZES |
|-----------------|--------|---------|-------|----------|--------|--------------|-------------|-----------|---------|
| 56-AG566 | 4121 | Nitrile | Green | Straight | 12" | Supported | MicroFinish | Interlock | XS - XL |
| 56-AG567 | 4121 | Nitrile | Green | Straight | 25" | Supported | MicroFinish | Interlock | S - XL |
| 56-AG585 | 4121 | Nitrile | Gray | Straight | 10" | Supported | MicroFinish | Interlock | XS - XL |
| 56-AG586 | 4121 | Nitrile | Gray | Straight | 12" | Supported | MicroFinish | Interlock | XS - XL |
| 56-AG588 | 4121 | Nitrile | Gray | Safety | 10" | Supported | MicroFinish | Interlock | S - XL |

ACTIVEGRIP™

FOR ADVANCED
CHEMICAL
PROTECTION

& CHEMGRIP™

EN 374
AJKL

57-8630

- Multi-dipped process provides fully liquid-proof protection
- Jersey liner for enhanced comfort
- Gauntlet cuff for added forearm protection
- Black color hides dirt

APPLICATIONS: Petrochemical, Refining, Material Handling, Degreasing, Chemical, Kitchen Cleanup, Plating, Galvanizing

CHEMGRIP™ NEOPRENE COATED GLOVE

| STYLE NUMBER | EN 374 | EN 388 | POLYMER | COLOR | CUFF | LENGTH | CONSTRUCTION | GRIP PATTERN | LINING | SIZES |
|-----------------|--------|--------|----------|-------|------------|--------|-------------------------|--------------|-------------------|-------|
| 57-8615 | AJKL | --- | Neoprene | Black | Knit Wrist | 10" | Supported, Multi-Dipped | Smooth | Jersey | L |
| 57-8630 | AJKL | --- | Neoprene | Black | Straight | 12" | Supported, Multi-Dipped | Smooth | Jersey | L |
| 57-8645 | AJKL | 3121 | Neoprene | Black | Straight | 18" | Supported, Multi-Dipped | Smooth | Brushed Interlock | L |
| 57-8675 | AJKL | 3121 | Neoprene | Black | Straight | 31" | Supported, Multi-Dipped | Smooth | Brushed Interlock | L |
| 57-8630R | AJKL | 3121 | Neoprene | Black | Straight | 12" | Supported, Multi-Dipped | Etched | Brushed Interlock | L |
| 57-8640R | AJKL | 3121 | Neoprene | Black | Straight | 14" | Supported, Multi-Dipped | Etched | Brushed Interlock | L |
| 57-8645R | AJKL | 3121 | Neoprene | Black | Straight | 18" | Supported, Multi-Dipped | Etched | Brushed Interlock | L |
| 57-8643R | AJKL | 3121 | Neoprene | Black | Straight | 18" | Supported, Multi-Dipped | Etched | Foam | L |
| 57-8653R | AJKL | 3121 | Neoprene | Black | Straight | 18" | Supported, Multi-Dipped | Etched | Foam | M - L |

CHEMICAL RESISTANT GLOVES

SELECTOR GUIDE



ONLINE SELECTOR GUIDE: MATCHES GLOVE TO CHEMICAL FOR MAXIMUM SAFETY

PIP offers a user-friendly Selector Guide for Chemical Protection. The Chemical Permeation Guide allows you to search by chemical name, CAS number or by PIP glove style.

The chemical permeation of our product is measured in accordance to European Standard EN 374-3. This measures the resistance of protective gloves against chemicals and microorganisms. Part 3 of the standard determines the level of resistance to permeation by chemicals.

www.pipusa.com

EN 374-3



AJK

WHAT IS THE ALPHA CODING LISTED BELOW PICTOGRAM?

EN 374-3 coding - In order for a glove to receive the pictogram as shown, the glove must achieve a breakthrough time >30 minutes for at least 3 chemicals from the 12 listed below.

BREAKTHROUGH TIME (BTT)

The number of minutes from initial contact with a test chemical until it is first detected on the inside of the glove

BREAKTHROUGH TIME - PROTECTION INDEX

Each chemical tested is classified in terms of breakthrough time (performance level 0 to 6)

PROTECTION INDEX

| | | |
|---|-------------|---------|
| > | 10 Minutes | Class 1 |
| > | 30 Minutes | Class 2 |
| > | 60 Minutes | Class 3 |
| > | 120 Minutes | Class 4 |
| > | 240 Minutes | Class 5 |
| > | 480 Minutes | Class 6 |

| CODE LETTER | CHEMICAL | GAS NUMBER | CATEGORY |
|-------------|----------------------|------------|------------------------------------|
| A | Methanol | 67-56-1 | Primary alcohol |
| B | Acetone | 67-64-1 | Ketone |
| C | Acetonitrile | 75-05-8 | Nitrile compound |
| D | Dichloromethane | 75-09-2 | Chlorinated paraffin |
| E | Carbon disulfide | 75-15-0 | Sulfur-containing organic compound |
| F | Toluene | 108-88-3 | Aromatic hydrocarbon |
| G | Diethylamine | 109-89-7 | Amine |
| H | Tetrahydrofurane | 109-99-9 | Heterocyclic and ethereal compound |
| I | Ethyl acetate | 141-78-6 | Ester |
| J | n-Heptane | 142-85-5 | Saturated hydrocarbon |
| K | Sodium hydroxide 40% | 1310-73-2 | Inorganic base |
| L | Sulfuric acid 96% | 7664-93-9 | Inorganic mineral acid |

DISPOSABLE GLOVES

POLYMER TECHNOLOGY

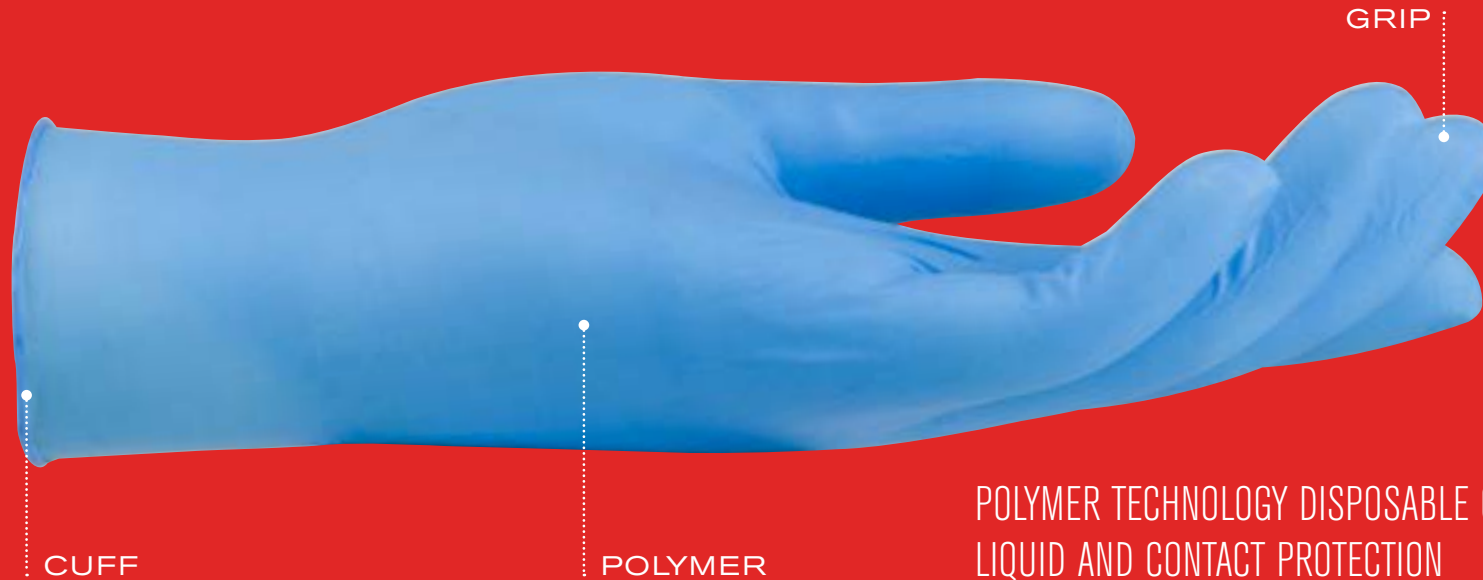

POLYMER TECHNOLOGY DISPOSABLE GLOVES, BUILT FOR LIQUID AND CONTACT PROTECTION

THE KEY TO PERFORMANCE IS SELECTING POLYMER MATERIAL AND THICKNESS

POLYMER MATERIALS

| POLYMER COATING | ADVANTAGE | PRECAUTION |
|---------------------|--|--|
| LATEX | - Superior flexibility and resistance to animal fats - Often used in cleaning, inspection, laboratory, and other light duty applications | - Latex intolerance with some users |
| NITRILE | - Good resistance to hydrocarbon derivatives as well as natural fats, oils and proteins. - Tough and resistant to abrasion, snags and perforation | - Avoid prolonged contact with ketones and aromatic solvents |
| VINYL | - Popular choice within the food industry as cost effective alternative for certain light duty tasks | - Less durable than nitrile or latex |
| POLYETHYLENE | - Most economical choice and is often used in food preparation | - Loose fitting and least durable |

MIL THICKNESS

A "MIL" IS A UNIT OF THICKNESS EQUAL TO ONE THOUSANDTH OF AN INCH.

| MIL | RECOMMENDED USE |
|---------------|---|
| 13 | - Exceptional tear and snag resistance for use in First Responder EMS or heavy duty industrial applications |
| 5 to 8 | - Food preparation, cleaning tasks, tattooing and industrial applications |
| 3 to 4 | - Single use food preparation and light duty |
| 1 to 2 | - Tasks that require constant glove change-outs such as in food service preparation |

POWDERED: Lightly dusted with cornstarch or other dry lubricants to make donning gloves easier. Can leave residual traces on surfaces affecting adhesion or paint bonding in manufacturing. Banned for use in Medical, Surgical or Examination applications.

POWDER-FREE: Manufactured using a chlorination process that creates a less tacky glove surface facilitating donning and leaving no residual traces on surfaces.

DISPOSABLE GLOVES

AMBI-DEX® NITRILE



Ambi-dex®



▲ 63-732PF



▲ 63-331PF

NITRILE GLOVES

FOR GENERAL DUTY
APPLICATIONS, DIRT & OIL



TEXTURED
GRIP

| AMBI-DEX® - NITRILE | | | | | | | | | |
|---------------------|--------|------|------------|-----------|-------|--------------|-------------|----------|------------|
| STYLE NUMBER | 21 CFR | CFIA | DUTY | THICKNESS | COLOR | GRIP PATTERN | POWDER | SIZES | BOX COUNT |
| 63-338 | Yes | No | Industrial | 8 mil | Blue | Textured | Powdered | S - XL | 50 pieces |
| 63-338PF | Yes | No | Industrial | 8 mil | Blue | Textured | Powder Free | S - XL | 50 pieces |
| 63-336 | Yes | No | Industrial | 6 mil | Blue | Textured | Powdered | S - XL | 100 pieces |
| 63-336PF | Yes | No | Industrial | 6 mil | Blue | Textured | Powder Free | S - XL | 100 pieces |
| 63-3314PF | Yes | No | Industrial | 6 mil | Blue | Textured | Powder Free | S - XL | 50 pieces |
| 63-332 | Yes | Yes | Industrial | 5 mil | Blue | Textured | Powdered | XS - XXL | 100 pieces |
| 63-332PF | Yes | Yes | Industrial | 5 mil | Blue | Textured | Powder Free | XS - XXL | 100 pieces |
| 63-732PF | No | No | Industrial | 5 mil | Black | Textured | Powder Free | S - XL | 100 pieces |
| 63-632PF | No | No | Industrial | 4 mil | Black | Textured | Powder Free | S - XL | 100 pieces |
| 63-331PF | Yes | No | Medical | 5 mil | Blue | Textured | Powder Free | S - XL | 100 pieces |
| 63-532 | Yes | Yes | Food | 4 mil | Blue | Textured | Powdered | S - XXL | 100 pieces |
| 63-532PF | Yes | Yes | Food | 4 mil | Blue | Textured | Powder Free | S - XL | 100 pieces |
| 63-510PF | Yes | Yes | Food | 4 mil | Blue | Textured | Powder Free | S - XL | 10 pieces |
| 63-550PF | Yes | Yes | Food | 4 mil | Blue | Textured | Powder Free | S - XL | 50 pieces |
| 63-230PF | Yes | No | Food | 3 mil | Blue | Textured | Powder Free | S - XL | 100 pieces |

DISPOSABLE GLOVES

AMBI-DEX® GRIPPAZ™



Ambi-dex®

Grippaz™

SUPERIOR AMBIDEXTROUS
NITRILE GLOVES WITH
STRENGTH AND GRIP



**AMBI-DEX®
GRIPPAZ™ SKINS
67-246**

- Chemical resistant
- Latex-free
- Fish scale surface for wet and dry grip
- Superb snug fit

APPLICATIONS: *Mechanics, Engineers, Agriculture, General Use and Chemical*



**AMBI-DEX®
GRIPPAZ™ JAN SAN
67-306**

- Chemical resistant
- Latex-free
- Fish scale surface for wet and dry grip
- Amazing fit

APPLICATIONS: *Janitorial and Cleaning*



**AMBI-DEX®
GRIPPAZ™ FOOD PLUS
67-308**

- Latex-free
- Fish scale surface for wet and dry grip
- Suitable for all food types
- Bagged for food environments

APPLICATIONS: *Food Handling, Janitorial, Cleaning and Agriculture*



FISH SCALE TEXTURE FOR EXCELLENT GRIP



FISH SCALE
SURFACE FOR
WET & DRY GRIP



CHEMICAL
RESISTANT



LATEX-FREE

AMBI-DEX® GRIPPAZ™

| STYLE NUMBER | 21 CFR | GRADE | THICKNESS | COLOR | GRIP PATTERN | POWDER | SIZES | BOX COUNT |
|---------------|--------|------------|-----------|--------|--------------|-------------|--------|---------------|
| 67-246 | Yes | Industrial | 6 mil | Black | Textured | Powder Free | S-XXL | 50 pieces |
| 67-306 | Yes | Jan San | 6 mil | Yellow | Textured | Powder Free | S-XXL | 48 pieces |
| 67-308 | Yes | Food | 8 mil | Blue | Textured | Powder Free | M-XXXL | 48 pieces/bag |

DISPOSABLE GLOVES

AMBI-DEX® LATEX

Ambi-dex

LATEX GLOVES

PERFORMANCE YOU CAN TRUST



AMBI-DEX® INDUSTRIAL GRADE

APPLICATIONS: *Production, Inspection, Cleaning*



AMBI-DEX® MEDICAL GRADE

APPLICATIONS: *Laboratories, Inspection, Examinations, Pharmacy*



AMBI-DEX® FOOD GRADE

APPLICATIONS: *Production, Inspection, Food Handling*



AMBI-DEX® - LATEX

| STYLE NUMBER | 21 CFR | CFIA | GRADE | THICKNESS | COLOR | GRIP PATTERN | POWDER | SIZES | BOX COUNT |
|-----------------|--------|------|------------|-----------|-----------|--------------|-------------|---------|------------|
| 62-310 | Yes | No | Industrial | 5 mil | ■ Natural | Textured | Powdered | XS - XL | 10 pieces |
| 62-350 | Yes | No | Industrial | 5 mil | ■ Natural | Textured | Powdered | XS - XL | 50 pieces |
| 62-322 | Yes | No | Industrial | 5 mil | ■ Natural | Textured | Powdered | XS - XL | 100 pieces |
| 62-322PF | Yes | No | Industrial | 5 mil | ■ Natural | Textured | Powder Free | XS - XL | 100 pieces |
| 62-321PF | Yes | No | Medical | 5 mil | ■ Natural | Textured | Powder Free | S - XL | 100 pieces |
| 62-323 | Yes | Yes | Food | 5 mil | ■ Natural | Textured | Powdered | S - XL | 100 pieces |
| 62-323PF | Yes | Yes | Food | 5 mil | ■ Natural | Textured | Powder Free | S - XL | 100 pieces |

WARNING: All styles listed on this page contain natural rubber latex which may cause allergic reactions.

Safe use by, or on latex-sensitive individuals has not been established. **POWDERED:** Lightly dusted with cornstarch or other dry lubricants to make donning gloves easier. Can leave residual traces on surfaces affecting adhesion or paint bonding in manufacturing. Banned for use in Medical, Surgical or Examination applications.

Ambi-Thix™

THICKER LATEX

ADDED
STRENGTH FOR
DEMANDING JOBS



**AMBI-THIX®
EXTRA-THICK LATEX INDUSTRIAL GRADE
62-327**

- 13 mil thickness for heavy duty applications
- 11 inches long for added forearm protection

APPLICATIONS: *Production, Inspection, Cleaning*



**AMBI-THIX®
EXTRA-THICK LATEX MEDICAL GRADE
62-327PF**

- 13 mil thickness for heavy duty applications
- 11 inches long for added forearm protection
- Meets the emergency medical glove requirements of NFPA 1999 Standard on Protective Clothing for Emergency Medical Operations, 2003

APPLICATIONS: *Emergency Responders, Lab Applications*

AMBI-THIX® - EXTRA-THICK LATEX

| STYLE NUMBER | 21 CFR | CFIA | GRADE | THICKNESS | COLOR | GRIP PATTERN | POWDER | SIZES | BOX COUNT |
|-----------------|--------|------|------------|-----------|-------|--------------|-------------|--------|-----------|
| 62-327 | No | No | Industrial | 13 mil | Blue | Textured | Powdered | S - XL | 50 pieces |
| 62-327PF | No | No | Medical | 13 mil | Blue | Textured | Powder Free | S - XL | 50 pieces |

WARNING: All styles listed on this page contain natural rubber latex which may cause allergic reactions. Safe use by, or on latex-sensitive individuals has not been established. **POWDERED:** Lightly dusted with cornstarch or other dry lubricants to make donning gloves easier. Can leave residual traces on surfaces affecting adhesion or paint bonding in manufacturing. Banned for use in Medical, Surgical or Examination applications.

DISPOSABLE GLOVES

AMBI-DEX® POLYETHYLENE / VINYL / NON-LATEX SYNTHETIC



AMBI-DEX® POLYETHYLENE EMBOSSED GRIP

- For better handling of wet or dry materials

APPLICATIONS: *Food Preparation and Services*



AMBI-DEX® POLYETHYLENE SILKY-FINISH GRIP

- Ensures effortless outer glove donning ability

APPLICATIONS: *Food Preparation and Services*

Ambi-dex®

POLYETHYLENE, VINYL & NON-LATEX SYNTHETIC GLOVES



▲ 64-V77B



▲ 64-436



▲ 64-V3000

AMBI-DEX® VINYL PREMIUM INDUSTRIAL GRADE

- Made from a soft virgin vinyl formulation specially compounded to deliver an optimal combination of comfort, fit, flexibility, tactile sensitivity and performance

APPLICATIONS: *Broad Range for Protection from Liquids and Debris, Food Processing, Inspections*

AMBI-DEX® VINYL INDUSTRIAL GRADE

APPLICATIONS: *Broad Range for Protection from Liquids and Debris, Food Processing, Inspections*



AMBI-DEX® NON-LATEX SYNTHETIC

- Have the look, fit and feel of latex without the concern of natural rubber latex proteins

APPLICATIONS: *Broad Range for Protection from Liquids and Debris, Food Processing, Inspections*

AMBI-DEX® - POLYETHYLENE

| STYLE NUMBER | 21 CFR | CFIA | GRADE | THICKNESS | COLOR | GRIP | POWDER | SIZES | BOX COUNT |
|---------------|--------|------|-------|-----------|---------|--------------|-------------|--------|------------|
| 65-543 | Yes | Yes | Food | 1 mil | ■ Clear | Embossed | Powder Free | S - XL | 100 pieces |
| 65-544 | Yes | Yes | Food | 1 mil | ■ Clear | Embossed | Powder Free | S - XL | 500 pieces |
| 65-545 | Yes | No | Food | 1 mil | ■ Clear | Embossed | Powder Free | L | 100 pieces |
| 65-553 | Yes | Yes | Food | 1 mil | ■ Clear | Silky Finish | Powder Free | S - XL | 100 pieces |

AMBI-DEX® - HEAVY DUTY VINYL

| | | | | | | | | | |
|------------------|-----|-----|------------|-------|---------|--------|-------------|--------|------------|
| 64-V77B | Yes | Yes | Industrial | 5 mil | ■ Blue | Smooth | Powdered | S - XL | 100 pieces |
| 64-V77BPF | Yes | Yes | Industrial | 5 mil | ■ Blue | Smooth | Powder Free | S - XL | 100 pieces |
| 64-436 | Yes | No | Industrial | 6 mil | ■ Green | Smooth | Powdered | S - XL | 100 pieces |
| 64-433 | Yes | No | Industrial | 6 mil | ■ Green | Smooth | Powdered | S - XL | 300 pieces |

AMBI-DEX® - VINYL

| | | | | | | | | | |
|-------------------|-----|-----|------------|-------|---------|--------|-------------|---------|------------|
| 64-V3000 | Yes | Yes | Industrial | 3 mil | ■ White | Smooth | Powdered | S - XL | 100 pieces |
| 64-V3000PF | Yes | Yes | Industrial | 3 mil | ■ White | Smooth | Powder Free | XS - XL | 100 pieces |
| 64-V2000 | Yes | Yes | Industrial | 5 mil | ■ White | Smooth | Powdered | S - XXL | 100 pieces |
| 64-V2000PF | Yes | Yes | Industrial | 5 mil | ■ White | Smooth | Powder Free | S - XXL | 100 pieces |

AMBI-DEX® - NON-LATEX SYNTHETIC

| | | | | | | | | | |
|-----------------|-----|----|------------|-------|---------|--------|-------------|--------|------------|
| 64-346 | Yes | No | Industrial | 4 mil | ■ White | Smooth | Powdered | S - XL | 100 pieces |
| 64-346PF | Yes | No | Industrial | 4 mil | ■ White | Smooth | Powder Free | S - XL | 100 pieces |

CONTROLLING CONTAMINATION

WHILE MORE THAN 30 DIFFERENT INDUSTRY SEGMENTS UTILIZE CLEANROOMS, 70% OF U.S. CLEANROOM FLOOR SPACE IS IN THE PHARMACEUTICAL, BIOTECHNOLOGY, SEMICONDUCTOR AND OTHER ELECTRONIC COMPONENT INDUSTRIES.

THERE ARE FOUR MAIN GROUPS OF CONTAMINANTS:



Particles, usually carried on air currents, are solid matter, such as human skin flakes, dust and fibers from clothing, particles from production materials or from tooling and equipment.



Microorganisms such as bacteria can be extremely dangerous if they are allowed to contaminate medicines or people that treat or are being treated.



Chemicals can react with the product and cause changes to the formulation or destroy the product.



Electrostatic discharge given off by the human body can be as high as 35,000 volts. The energy attracts particles and, as these particles colonize in one place, they cause particulate damage. The discharge itself can also cause severe damage.

CLASSIFICATION - PARTICLES PER M³

| ISO 14644 CLASS | 209E CLASS | 0.5 MICRON | 5 MICRON |
|-----------------|------------|------------|----------|
| 3 | 1 | 35 | --- |
| 4 | 10 | 352 | --- |
| 5 | 100 | 3,520 | 29 |
| 6 | 1,000 | 35,200 | 293 |
| 7 | 10,000 | 352,000 | 2,930 |
| 8 | 100,000 | 3,520,000 | 29,300 |

102 AMBI-DEX®
STERILE LATEX GLOVES

103 CLEANTEAM®
SINGLE-USE GLOVES

104 CLEANTEAM®
SEAMLESS KNIT GLOVES
FOR FINE WORK

106 CLEANTEAM® LINT-FREE
GLOVES FOR INSPECTION

108 EXTREME TEMPERATURE
GLOVES & APRONS

108 MATS & PAPER

CRITICAL ENVIRONMENT

CRITICAL ENVIRONMENT GLOVES

AMBI-DEX® STERILE LATEX



AMBI-DEX® 100-3201PF

- Textured palm and finger enhance grip in wet and dry conditions
- Sterilized by gamma radiation
- Meets federal and ASTM standards for protein content
- Hand specific
- Powder free
- Pair packed

APPLICATIONS: *Surgeons and Medical*

HAND SPECIFIC
SURGEON STYLE
MEDICAL GRADE

STERILE LATEX

AMBI-DEX® MEDICAL GRADE STERILE LATEX

| STYLE NUMBER | POLYMER | POWDER | GRIP | LENGTH | MIL | STERILE | COLOR | SIZING | GLOVES/BOX |
|--------------|---------|-------------|------------------------|--------|-----|---------|---------|-----------|------------|
| 100-3201PF | Latex | Powder Free | Textured Palm & Finger | 11" | 5 | Yes | ■ White | 6.0 - 8.5 | 200 pair |

SINGLE-USE

LATEX, NITRILE & VINYL



- CLEANTEAM®**
100-323010
- Fully textured for a superior grip in wet and dry conditions
 - Beaded cuff provides additional strength and protection
 - Ambidextrous
 - Powder free
 - Double-bagged in sealed clean room bags

APPLICATIONS: *Biotechnology, Medical Device Manufacturing, Laboratory, Cleanroom*



- CLEANTEAM®**
100-333010
- Textured finger for enhanced grip in wet and dry conditions
 - Beaded cuff provides additional strength and protection
 - Electrostatic Dissipative for improved performance in electronics assembly
 - Ambidextrous
 - Powder free
 - Double-bagged in sealed clean room bags

APPLICATIONS: *Biotechnology, Medical Device Manufacturing, Laboratory, Computer Assembly, Cleanroom*



- CLEANTEAM®**
100-2830
- Beaded cuff provides additional strength and protection
 - Electrostatic Dissipative for improved performance in electronics assembly
 - Ambidextrous
 - Powder free
 - Double-bagged in sealed clean room bags

APPLICATIONS: *Biotechnology, Medical Device Manufacturing, Laboratory, Computer Assembly, Cleanroom*

CLEANTEAM® SINGLE-USE LATEX

| STYLE NUMBER | POLYMER | DESCRIPTION | GRIP | CLASS | LENGTH | MIL | COLOR | SIZING | GLOVES/BAG |
|----------------------------|---------|-------------|------------------------|-------|--------|-----|-----------|--------|------------|
| 100-323010 | Latex | Powder Free | Textured Palm & Finger | 10 | 12" | 7 | ■ Natural | S - XL | 100 gloves |
| 100-323000 | Latex | Powder Free | Textured Palm & Finger | 100 | 12" | 7 | ■ Natural | S - XL | 100 gloves |
| 100-322400 | Latex | Powder Free | Textured Palm & Finger | 100 | 9.5" | 7 | ■ Natural | S - XL | 100 gloves |

CLEANTEAM® SINGLE-USE NITRILE

| | | | | | | | | | |
|----------------------------|---------|-------------|------------------------|-----|------|---|---------|--------|------------|
| 100-333010 | Nitrile | Powder Free | Textured Palm & Finger | 10 | 12" | 5 | ■ White | S - XL | 100 gloves |
| 100-333000 | Nitrile | Powder Free | Textured Palm & Finger | 100 | 12" | 5 | ■ White | S - XL | 100 gloves |
| 100-332400 | Nitrile | Powder Free | Textured Palm & Finger | 100 | 9.5" | 5 | ■ White | S - XL | 100 gloves |

CLEANTEAM® SINGLE-USE VINYL

| | | | | | | | | | |
|--------------------------|-------|-------------|--------|----|------|---|---------|--------|------------|
| 100-2824 | Vinyl | Powder Free | Smooth | 10 | 9.5" | 5 | ■ Clear | S - XL | 100 gloves |
| 100-2830 | Vinyl | Powder Free | Smooth | 10 | 12" | 5 | ■ Clear | S - XL | 100 gloves |

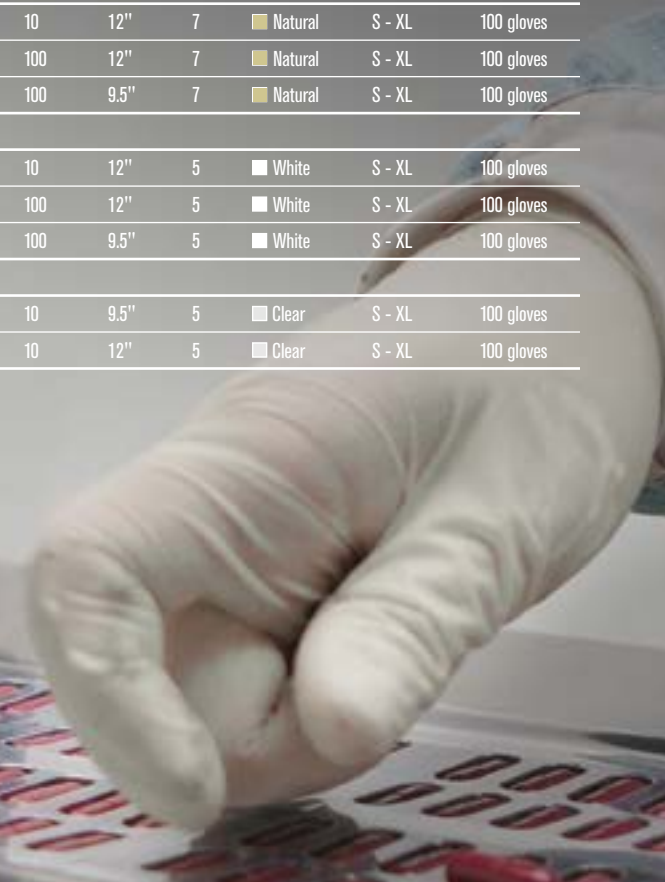

CRITICAL ENVIRONMENT GLOVES

CLEANTEAM® SEAMLESS KNIT GLOVES FOR FINE WORK

SEAMLESS KNIT

FOR CRITICAL ENVIRONMENT

CRITICAL ENVIRONMENT GLOVES

CLEANTEAM® SEAMLESS KNIT GLOVES FOR FINE WORK



← **CLEANTEAM®** **40-C125**

- Polyurethane coated palm and fingers to provide puncture and abrasion resistance while offering excellent tactile sensitivity
- Comfortable seamless knit design provides superior comfort and dexterity

APPLICATIONS: *Product Handling, Finishing, Assembly, Electronics Assembly, Photography Labs, Computer Manufacturing*



← **CLEANTEAM®** **40-730**

- Lightweight design can be worn under disposable and other liquid-proof gloves
- Nylon yarns absorb perspiration and leave hands cool and comfortable

APPLICATIONS: *Product Handling, Finishing, Assembly, Electronics Assembly, Photography Labs, Computer Manufacturing*



← **CLEANTEAM®** **40-6410**

- Electrostatic Dissipative (ESD) fiber yarns blended with low lint nylon which reduces static build-up on the glove surface
- Seamless knit gloves provide great dexterity
- Launderable and reusable without losing ESD properties

APPLICATIONS: *Circuit Board Manufacturing, Munitions, Electronics Assembly, Aerospace*



← **CLEANTEAM®** **40-130**

- Made in the USA
- Low linting
- Polyester can be UV irradiated to sterilize

APPLICATIONS: *Paint Rooms, Electronic Assembly, Pharmaceutical Production*

LOW LINTING



← **CLEANTEAM®** **40-6415**

- Excellent properties in electrostatic dissipation, electromagnetic wave shielding and thermal conductance
- Copper fiber provides good thermal conductance

APPLICATIONS: *Circuit Board Manufacturing, Munitions, Electronics Assembly, Aerospace*

CLEANTEAM® NYLON SEAMLESS KNIT

| STYLE NUMBER | MATERIAL | CONSTRUCTION | COLOR | GAUGE | COATING | COATING COLOR | COVERAGE | SIZES |
|----------------|----------|----------------------------|---------|-------|--------------|---------------|----------------|----------|
| 40-C125 | Nylon | Seamless Knit | ■ White | 13 | Polyurethane | ■ White | Palm & Fingers | XS - XXL |
| 99-126 | Nylon | Seamless Knit | ■ White | 13 | Polyurethane | ■ White | Fingertips | S - XL |
| 40-736 | Nylon | Seamless Knit, Half-Finger | ■ White | 13 | --- | --- | --- | S & L |
| 40-732 | Nylon | Seamless Knit, Half-Finger | ■ White | 13 | --- | --- | --- | S - XL |
| 40-730 | Nylon | Seamless Knit | ■ White | 13 | --- | --- | --- | S - XL |
| 40-750 | Nylon | Seamless Knit | ■ White | 10 | --- | --- | --- | S & L |

CLEANTEAM® POLYESTER SEAMLESS KNIT

| | | | | | | | | |
|-----------------|-----------|---------------|---------|----|-----|-----|-----|---------|
| 40-C2210 | Polyester | Seamless Knit | ■ White | 10 | --- | --- | --- | S & L |
| 40-C2130 | Polyester | Seamless Knit | ■ White | 13 | --- | --- | --- | S - XL |
| 40-130 | Polyester | Seamless Knit | ■ White | 13 | --- | --- | --- | XS - XL |
| 40-230 | Polyester | Seamless Knit | ■ White | 13 | --- | --- | --- | S - XL |

CLEANTEAM® NYLON ELECTROSTATIC DISSIPATIVE (ESD)

| | | | | | | | | |
|----------------|----------------|---------------|----------------|----|--------------|----------|-------------------|---------|
| 40-630 | Nylon | Seamless Knit | ■ White | 13 | --- | --- | --- | XS - XL |
| 40-6410 | Nylon / Carbon | Seamless Knit | ■ White / Gray | 13 | --- | --- | --- | S - XXL |
| 40-6411 | Nylon / Carbon | Seamless Knit | ■ White / Gray | 13 | PVC Dot | ■ White | Palm | S & L |
| 40-6416 | Nylon / Copper | Seamless Knit | ■ White | 13 | Polyurethane | ■ Copper | Fingertips | S & L |
| 40-6415 | Nylon / Copper | Seamless Knit | ■ White | 13 | Polyurethane | ■ Copper | Palm & Fingertips | S & L |

CRITICAL ENVIRONMENT GLOVES

CLEANTEAM® LINT-FREE GLOVES FOR INSPECTION



**CLEANTEAM®
97-500**

- Ambidextrous
- Unhemmed

APPLICATIONS: *Inspection,
Electronics Assembly*



**CLEANTEAM®
97-520R**

- Ambidextrous
- Rolled hem

APPLICATIONS: *Inspection,
Electronics Assembly*



**CLEANTEAM®
97-540H**

- Ambidextrous
- Hemmed

APPLICATIONS: *Inspection,
Electronics Assembly*

PIP IS A LEADER IN THE MANUFACTURING OF FABRIC INSPECTION

CLEANTEAM® COTTON SEAMLESS KNIT – LIGHTWEIGHT, ECONOMY

| STYLE NUMBER | MATERIAL | CONSTRUCTION | HEM | LENGTH | COLOR | WEIGHT | SIZES |
|--------------------|--------------------|--------------|----------|--------|---------|--------|---------|
| 97-510 | Cotton / Polyester | Cut-and-Sewn | Unhemmed | 9" | ■ White | Light | Men's |
| 97-511 | Cotton / Polyester | Cut-and-Sewn | Unhemmed | 9" | ■ White | Light | Ladies' |
| 97-500I | Cotton | Cut-and-Sewn | Unhemmed | 9" | ■ White | Light | Men's |
| 97-501I | Cotton | Cut-and-Sewn | Unhemmed | 9" | ■ White | Light | Ladies' |
| 97-500/14I | Cotton | Cut-and-Sewn | Unhemmed | 14" | ■ White | Light | Men's |
| 97-500/14NI | Cotton | Cut-and-Sewn | Unhemmed | 14" | ■ White | Light | Men's |

CLEANTEAM® COTTON SEAMLESS KNIT – LIGHTWEIGHT, PREMIUM

| | | | | | | | |
|------------------|--------|--------------|----------|-------|---------|-------|---------|
| 97-500 | Cotton | Cut-and-Sewn | Unhemmed | 9" | ■ White | Light | Men's |
| 97-501 | Cotton | Cut-and-Sewn | Unhemmed | 9" | ■ White | Light | Ladies' |
| 97-500J | Cotton | Cut-and-Sewn | Unhemmed | 9" | ■ White | Light | Jumbo |
| 97-500H | Cotton | Cut-and-Sewn | Hemmed | 9" | ■ White | Light | Men's |
| 97-501H | Cotton | Cut-and-Sewn | Hemmed | 9" | ■ White | Light | Ladies' |
| 97-500/10 | Cotton | Cut-and-Sewn | Unhemmed | 10.5" | ■ White | Light | Men's |
| 97-501/10 | Cotton | Cut-and-Sewn | Unhemmed | 10.5" | ■ White | Light | Ladies' |
| 97-501/12 | Cotton | Cut-and-Sewn | Unhemmed | 12" | ■ White | Light | Ladies' |
| 97-500/12 | Cotton | Cut-and-Sewn | Unhemmed | 12" | ■ White | Light | Men's |
| 97-500/14 | Cotton | Cut-and-Sewn | Unhemmed | 14" | ■ White | Light | Men's |

CLEANTEAM® COTTON SEAMLESS KNIT – MEDIUM WEIGHT

| STYLE NUMBER | MATERIAL | CONSTRUCTION | HEM | LENGTH | COLOR | WEIGHT | SIZES |
|-------------------|----------|--------------|----------|--------|---------|--------|---------|
| 97-520 | Cotton | Cut-and-Sewn | Unhemmed | 9.5" | ■ White | Medium | Men's |
| 97-521 | Cotton | Cut-and-Sewn | Unhemmed | 9" | ■ White | Medium | Ladies' |
| 97-520J | Cotton | Cut-and-Sewn | Unhemmed | 9.5" | ■ White | Medium | Jumbo |
| 97-520H | Cotton | Cut-and-Sewn | Hemmed | 9.5" | ■ White | Medium | Men's |
| 97-521H | Cotton | Cut-and-Sewn | Hemmed | 9" | ■ White | Medium | Ladies' |
| 97-520R | Cotton | Cut-and-Sewn | Rolled | 9.5" | ■ White | Medium | Men's |
| 97-520/10 | Cotton | Cut-and-Sewn | Unhemmed | 10.5" | ■ White | Medium | Men's |
| 97-521/10 | Cotton | Cut-and-Sewn | Unhemmed | 10.5" | ■ White | Medium | Ladies' |
| 97-520/12 | Cotton | Cut-and-Sewn | Unhemmed | 12" | ■ White | Medium | Men's |
| 97-520/14 | Cotton | Cut-and-Sewn | Unhemmed | 14" | ■ White | Medium | Men's |
| 97-520/12R | Cotton | Cut-and-Sewn | Rolled | 12" | ■ White | Medium | Ladies' |

CRITICAL ENVIRONMENT GLOVES

CLEANTEAM® LINT-FREE GLOVES FOR INSPECTION



98-702

- Stretch nylon, two piece pattern
- Zigzag stitched hem

APPLICATIONS: *Inspection, Electronics Assembly*



GLOVES FOR ALL CRITICAL ENVIRONMENTS

CLEANTEAM® COTTON SEAMLESS KNIT - HEAVYWEIGHT

| STYLE NUMBER | MATERIAL | CONSTRUCTION | HEM | LENGTH | COLOR | WEIGHT | SIZES |
|--------------------|----------|--------------|---|--------|---------|--------|---------|
| 97-540 | Cotton | Cut-and-Sewn | Unhemmed | 9" | ■ White | Heavy | Men's |
| 97-540H | Cotton | Cut-and-Sewn | Hemmed | 9" | ■ White | Heavy | Men's |
| 97-540/12 | Cotton | Cut-and-Sewn | Unhemmed | 12" | ■ White | Heavy | Men's |
| 97-541/12 | Cotton | Cut-and-Sewn | Unhemmed | 12" | ■ White | Heavy | Ladies' |
| 97-540R | Cotton | Cut-and-Sewn | Rolled | 10" | ■ White | Heavy | Men's |
| 97-541 | Cotton | Cut-and-Sewn | Unhemmed | 8.5" | ■ White | Heavy | Ladies' |
| 97-541H | Cotton | Cut-and-Sewn | Rolled | 8.5" | ■ White | Heavy | Ladies' |
| 130-100WMNZ | Cotton | Cut-and-Sewn | Open Cuff, <i>no raised stitching on the back</i> | 9" | ■ White | Heavy | XS - XL |

CLEANTEAM® NYLON SEAMLESS KNIT - HEAVYWEIGHT

| STYLE NUMBER | MATERIAL | CONSTRUCTION | HEM | LENGTH | COLOR | WEIGHT | SIZES |
|------------------|----------|--------------|---------------|--------|---------|--------|---------------|
| 98-740 | Nylon | Cut-and-Sewn | Hemmed | 9" | ■ White | Light | Men's S -XXL |
| 98-741 | Nylon | Cut-and-Sewn | Hemmed | 8.5" | ■ White | Light | Ladies' S - L |
| 98-702 | Nylon | Cut-and-Sewn | Zigzag Stitch | 9" | ■ White | Light | Men's |
| 98-702I | Nylon | Cut-and-Sewn | Zigzag Stitch | 9" | ■ White | Light | Men's |
| 98-702/12 | Nylon | Cut-and-Sewn | Zigzag Stitch | 12" | ■ White | Light | Men's |
| 98-703 | Nylon | Cut-and-Sewn | Zigzag Stitch | 8.5" | ■ White | Light | Ladies' |
| 98-703I | Nylon | Cut-and-Sewn | Zigzag Stitch | 8.5" | ■ White | Light | Ladies' |
| 98-703/12 | Nylon | Cut-and-Sewn | Zigzag Stitch | 12" | ■ White | Light | Ladies' |
| 98-700 | Nylon | Cut-and-Sewn | Zigzag Stitch | 9" | ■ White | Heavy | Men's |
| 98-701 | Nylon | Cut-and-Sewn | Zigzag Stitch | 8.5" | ■ White | Heavy | Ladies' |
| 98-712 | Nylon | Cut-and-Sewn | Zigzag Stitch | 9" | ■ White | Heavy | Men's |
| 98-713 | Nylon | Cut-and-Sewn | Zigzag Stitch | 8.5" | ■ White | Heavy | Ladies' |

CRITICAL ENVIRONMENT

EXTREME TEMPERATURE / MATS & PAPER

EXTREME TEMPERATURE PROTECTION



▲ [202-1027](#) ▲ [202-1019](#) ▲ [202-1015](#) ▲ [202-1012](#)

TEMP-GARD® LIQUID-PROOF SILICONE EXTREME TEMPERATURE GLOVE

IDEAL FOR USE IN WORK ENVIRONMENTS TO PROTECT FROM EXTREME TEMPERATURES OF -321°F (-196°C) TO +500°F (+260°C), SUCH AS CRYOGENIC CLEANING, CRYOGENIC SYSTEMS MAINTENANCE, CONSERVATION OF FOOD PRODUCE

- Impervious to cryogenic liquids and most other liquids and chemicals
- Exceptional grip that does not become slippery, even at extreme temperatures
- Superior flexibility that will not stiffen
- Improved dexterity at all temperatures
- Easy to clean, will not absorb chemicals and will not stain. The silicone coating is on the outside of the gloves (rather than inside), so it prevents staining and can easily be rinsed off after use

| ITEM NUMBER | COLOR | MATERIAL | LENGTH | SIZES |
|--------------------------|---------|-----------------------|----------|-------|
| 202-1012 | ■ Black | Liquid-Proof Silicone | Wrist | S - L |
| 202-1015 | ■ Black | Liquid-Proof Silicone | Mid-Arm | S - L |
| 202-1019 | ■ Black | Liquid-Proof Silicone | Elbow | S - L |
| 202-1027 | ■ Black | Liquid-Proof Silicone | Shoulder | S - L |



TEMP-GARD® EXTREME TEMPERATURE APRONS

- Multi-layered construction for maximum thermal protection
- Liquid-proof outer layer to protect from splashes
- Quick release buckles at neck and waist for added safety

| ITEM NUMBER | COLOR | MATERIAL | LENGTH |
|--------------------------|---------|-----------------------|--------|
| 202-2036 | ■ Black | Liquid-Proof Silicone | 36" |
| 202-2042 | ■ Black | Liquid-Proof Silicone | 42" |
| 202-2048 | ■ Black | Liquid-Proof Silicone | 48" |
| 202-2054 | ■ Black | Liquid-Proof Silicone | 54" |



CONTAMINATION CONTROL MATS

- Specially designed adhesive coated mats reduce foot borne dust and particulates from entering cleanrooms and controlled environments
- Available in white, blue or gray

| ITEM NUMBER | SIZE | LAYERS | PACKS PER CASE |
|-------------------------------|-----------|--------|----------------|
| 100-93-183638 | 18" x 36" | 30 | 8 |
| 100-93-184538 | 18" x 45" | 30 | 8 |
| 100-93-243638 | 24" x 36" | 30 | 8 |
| 100-93-264538 | 26" x 45" | 30 | 8 |
| 100-93-264564 | 26" x 45" | 60 | 4 |
| 100-93-363638 | 36" x 36" | 30 | 8 |
| 100-93-363664 | 36" x 36" | 60 | 4 |
| 100-93-364538 | 36" x 45" | 30 | 8 |
| 100-93-364564 | 36" x 45" | 60 | 4 |
| 100-93-366064 | 36" x 60" | 60 | 4 |

CLEANROOM PAPER

- Paper's antistatic properties reduce attraction of airborne particles and enhance its performance in photocopiers and converting processes
- Chemical and moisture resistant
- Available in white, light blue, yellow, green and pink

| ITEM NUMBER | SIZE | WEIGHT | PACKAGING |
|----------------------------|------------|--------|--|
| 100-95-501 | 8.5" x 11" | 22# | 250 sheets per pack 10 packs per case |



HIGH PERFORMANCE **TASK SPECIFIC PROTECTION**

THE NEED FOR MULTI-FACETED PROTECTION IS SOMETHING ONLY CUT AND SEWN GLOVES, USING ADVANCED, COMPOSITE MATERIALS CAN ACHIEVE. KEY MARKETS THAT ARE IN NEED OF TASK SPECIFIC GLOVES ARE OIL & GAS, CONSTRUCTION, ELECTRICAL AND GAS UTILITY, AND MECHANICAL TRADES.

EACH OF THESE MARKETS HAS SPECIFIC NEEDS



Impact Resistance

Impact resistant gloves aim to reduce injury from blunt force against the top of the hand and fingers. Thermoplastic Rubber (TPR) is the common material found on impact resistant gloves to reduce top of hand injuries. Key applications include: Oil & Gas, Heavy Industry, Mining, Trench Work and Construction



Flame & Heat Resistance

Covers everything from Flame Resistance, Arc Protection, Hot Mill and Welder's gloves, as well as gloves certified for fighting structural fires.



Cold Protection

Gloves for working in cold climates or in refrigerated warehouses rely on thermal lining or winterized membranes.



Ergonomic Design

Advancement in pattern engineering software and sewing machinery combine to produce gloves that mimic the natural hand. When constructed with advanced, composite materials, task specific gloves offer features that can solve almost any hand protection problem.

110 OIL & GAS GLOVES

112 MINING GLOVES

113 CONSTRUCTION & INDUSTRIAL GLOVES

115 MECHANICS GLOVES

116 LIFTING & SHOCK ABSORBING GLOVES

117 UTILITY GLOVES

118 ELECTRICAL ARC RATED GLOVES

HIGH PERFORMANCE GLOVES

HIGH PERFORMANCE GLOVES

OIL & GAS

MAXIMUM SAFETY® MAD MAX™

- Synthetic leather palm for good grip in dry and slightly oily conditions
- Thermoplastic rubber (TPR) guards for pinch point protection
- Dorsal protection against impact to the back of the hand
- Reinforced thumb joint
- Foam padded knuckle
- Reinforced index finger

APPLICATIONS: Petrochemical,
Heavy/Light Construction, Demolition,
Manufacturing, Mining, Rigging, Fabrication



ANSI
A3

MAXIMUM SAFETY® TUFFMAX™

- Lightweight HPPE knit liner provides excellent dexterity and tactile sensitivity
- Thermoplastic rubber (TPR) guards for pinch point protection
- MicroSurface nitrile for enhanced grip in wet, dry and oily applications
- Dorsal protection against impact to the back of the hand
- Excellent puncture resistance
- Extended cuff for additional protection

APPLICATIONS: Petrochemical,
Heavy/Light Construction, Demolition,
Manufacturing, Mining, Rigging, Fabrication



**MAXIMUM
SAFETY**

MAXIMUM SAFETY® MAD MAX™

| STYLE NUMBER | ANSI | EN388 | GRIP | BACK | CUFF | COLOR | SIZES |
|-----------------|------|-------|------------------|---------|---------|-----------------------|---------|
| 120-4000 | A2 | 3121 | PVC Diamond Grip | Spandex | Slip-On | Hi-Vis Yellow / Black | S - XXL |
| 120-4050 | --- | 4121 | PVC Dot | Spandex | Slip-On | Hi-Vis Yellow / Black | S - XXL |
| 120-4070 | --- | 3121 | PVC Sandy Grip | Spandex | Slip-On | Hi-Vis Yellow / Black | S - XXL |

MAXIMUM SAFETY® TUFFMAX™

| | | | | | | | |
|-----------------|----|------|----------------------|------|----------------------------------|-----------------------|---------|
| 120-5150 | A3 | 4544 | Nitrile MicroSurface | HPPE | Slip-On with Hook & Loop Closure | Hi-Vis Orange / Black | M - XXL |
| 120-5130 | A2 | 4344 | Nitrile MicroSurface | HPPE | Slip-On with Hook & Loop Closure | Hi-Vis Green / Black | M - XXL |



OIL

HIGH PERFORMANCE GLOVES

OIL & GAS



& GAS



KEVLAR® STITCHED

▲ [120-5200](#)



KEVLAR® LINED

▲ [120-5250](#)



WATERPROOF LINER

▲ [120-5275](#)



REFLECTIVE BACK

▲ [120-5300](#)

MAXIMUM SAFETY® ROUSTABOUT™

- Synthetic leather palm with silicone for enhanced grip in wet and dry applications
- Thermoplastic rubber (TPR) guards
- Dorsal protection
- Padding in palm for added comfort
- Kevlar® stitched for added durability
- Kevlar® fabric reinforced thumb joint for extended glove life
- ID badge on wrist

APPLICATIONS: *Petrochemical, Heavy/Light Construction, Fleet and Mechanical Repair, Demolition, Manufacturing, Mining, Rigging, Fabrication, Landscaping*

MAXIMUM SAFETY® ROUSTABOUT™

| STYLE NUMBER | EN388 | GRIP | BACK | CUFF | COLOR | SIZES |
|--------------------------|-------|----------|---------|---------|-----------------------|---------|
| 120-5200 | 3132 | Silicone | Spandex | Slip-On | Hi-Vis Yellow / Black | M - XXL |
| 120-5250 | 3333 | Silicone | Spandex | Slip-On | Hi-Vis Yellow / Black | M - XXL |
| 120-5275 | 3333 | Silicone | Spandex | Slip-On | Hi-Vis Yellow / Black | M - XXL |
| 120-5300 | 3132 | Silicone | Spandex | Slip-On | Hi-Vis Orange / Black | M - XXL |

MAXIMUM SAFETY

HIGH PERFORMANCE GLOVES

OIL, GAS & MINING



▲ 120-5900

MAXIMUM SAFETY® MOG™

- Synthetic leather palm with reinforcements, for an enhanced grip in dry and slightly oily conditions
- Thermoplastic rubber (TPR) guards for pinch point protection
- Dorsal protection against impact to the back of the hand
- Back of the hand guard

APPLICATIONS: *Petrochemical, Light Construction, Auto Repair, Demolition, Manufacturing, Mining, Fabrication, Landscaping*



▲ 120-4720

MAXIMUM SAFETY® DERRICKMEN™

- Thermoplastic rubber (TPR) guards for pinch point protection
- Polycord canvas for additional comfort
- Rubber bumper for knuckle protection
- Reflective knuckle
- Double stitching at seams for additional durability and strength

APPLICATIONS: *Petrochemical, Light Construction, Auto Repair, Demolition, Manufacturing, Mining, Fabrication, Landscaping*



▲ 120-4700

MAXIMUM SAFETY® MINER'S MIRACLE™

- Synthetic leather palm with reinforcements for an enhanced grip in dry and slightly oily conditions
- Thermoplastic rubber (TPR) guards for pinch point protection
- Rubber bumper knuckle protection
- Reflective knuckle
- Double stitching at seams

APPLICATIONS: *Petrochemical, Light Construction, Auto Repair, Demolition, Manufacturing, Mining, Fabrication, Landscaping*

MAXIMUM SAFETY® MOG™

| STYLE NUMBER | EN 388 | GRIP | BACK | CUFF | COLOR | SIZES |
|--------------|--------|----------------|---------|--------------------------|-----------------------|----------|
| 120-5900 | 3111 | PVC Sandy Grip | Spandex | Slip-On with Hook & Loop | Hi-Vis Orange / Black | M - XXXL |

MAXIMUM SAFETY® DERRICKMEN™

| | | | | | | |
|----------|------|-----------------|---------|--------------------------|-----------------------|---------|
| 120-4720 | 1221 | Polycord Canvas | Spandex | Slip-On with Hook & Loop | Hi-Vis Orange / Black | M - XXL |
|----------|------|-----------------|---------|--------------------------|-----------------------|---------|

MAXIMUM SAFETY® MINER'S MIRACLE™

| | | | | | | |
|----------|------|-------------|---------|--------------------------|-----------------------|---------|
| 120-4700 | 4131 | PVC Popcorn | Spandex | Slip-On with Hook & Loop | Hi-Vis Orange / Black | S - XXL |
|----------|------|-------------|---------|--------------------------|-----------------------|---------|

MAXIMUM
SAFETY



GLOVES FOR CONSTRUCTION



▲ [120-4200](#)

▲ [120-4100](#)

▲ [120-4150](#)

KEVLAR® LINED

◀ **MAXIMUM SAFETY®**

- Reinforced goatskin leather palm and back provides abrasion resistance and comfort
- Thermoplastic rubber (TPR) guards for added protection
- Internal foam padded palm absorbs and dampens shock
- Reinforced thumb joint for extended glove life
- Reflective knuckle tape for visibility in low-light applications

APPLICATIONS: *Heavy/Light Construction, Excavation, Demolition, Manufacturing, Mining, Fabrication, Landscaping*

MAXIMUM SAFETY®

| STYLE NUMBER | EN 388 | GRIP | BACK | CUFF | COLOR | SIZES |
|--------------------------|--------|------------------|-----------------------------|---------|-----------------|----------|
| 120-4200 | 2112 | Goatskin Leather | Reinforced Goatskin Leather | Slip-On | ☑ Brown / Black | S - XXL |
| 120-4100 | 2332 | Goatskin Leather | Reinforced Goatskin Leather | Slip-On | ☑ Brown / Black | S - XXL |
| 120-4150 | 2332 | Goatskin Leather | Reinforced Goatskin Leather | Slip-On | ☑ Brown / Black | S - XXXL |

HIGH PERFORMANCE GLOVES

CONSTRUCTION & INDUSTRIAL



▲ 120-4400

MAXIMUM SAFETY® GUNNER-AV™

- Synthetic leather palm provides dexterity and a good grip in dry and slightly oily applications
- PVC sandy grip on palm, thumb joint, upper knuckle and fingertips
- Reinforced thumb joint for extended glove life
- Reflective piping across back for visibility in low-light applications

APPLICATIONS: *Heavy/Light Construction, Excavation, Demolition, Manufacturing, Mining, Fabrication, Landscaping*



▲ 120-4300

MAXIMUM SAFETY® GUNNER™

- Half-finger design for dexterity
- Synthetic leather pull-off hooks on fingers for easy on/off
- PVC sandy grip on palm & thumb joint
- Reinforced thumb joint for extended glove life

APPLICATIONS: *Heavy/Light Construction, Excavation, Demolition, Manufacturing, Mining, Fabrication, Landscaping*



▲ 120-4500

MAXIMUM SAFETY® TORQUE™

- Silicone triangle grip palm for enhanced grip
- Reinforced thumb joint for extended glove life
- Reflective tape on fingertips and back of hand for visibility in low-light applications

APPLICATIONS: *Heavy/Light Construction, Excavation, Demolition, Manufacturing, Mining, Fabrication, Landscaping*



▲ 120-4600

MAXIMUM SAFETY® VIZ™

- Silicone grip on index finger and thumb for small parts handling
- Reinforced thumb joint for extended glove life
- Hi-Vis color for enhanced visibility

APPLICATIONS: *Road Construction, Traffic Safety, Highway Maintenance, Manufacturing, Fleet maintenance*



▲ 120-4900

MAXIMUM SAFETY® BRICKYARD™

- Silicone grip on palm for improved grip
- Thermoplastic rubber (TPR) finger guards for pinch-point protection and hand guard for back of the hand protection

APPLICATIONS: *Road Construction, Traffic Safety, Highway Maintenance, Manufacturing, Fleet Maintenance*

TAILORED TO THE JOB



MAXIMUM SAFETY® GUNNER™

| STYLE NUMBER | GRIP | BACK | CUFF | COLOR | SIZES |
|-----------------|----------------|------------------|----------------------------------|---|---------|
| 120-4400 | PVC Sandy Grip | Neoprene / Nylon | Slip-On with Hook & Loop Closure | <input type="checkbox"/> Black / Gray | S - XXL |
| 120-4300 | PVC Sandy Grip | Neoprene / Nylon | Slip-On with Hook & Loop Closure | <input checked="" type="checkbox"/> Gray / Yellow | S - XXL |

MAXIMUM SAFETY® TORQUE™

| | | | | | |
|-----------------|----------|------------------|----------------------------------|---------------------------------------|---------|
| 120-4500 | Silicone | Neoprene / Nylon | Slip-On with Hook & Loop Closure | <input type="checkbox"/> Gray / Black | S - XXL |
|-----------------|----------|------------------|----------------------------------|---------------------------------------|---------|

MAXIMUM SAFETY® VIZ™

| | | | | | |
|-----------------|----------|---------|---------|---|---------|
| 120-4600 | Silicone | Spandex | Slip-On | <input checked="" type="checkbox"/> Hi-Vis Orange / Black | S - XXL |
|-----------------|----------|---------|---------|---|---------|

MAXIMUM SAFETY® BRICKYARD™

| | | | | | |
|-----------------|----------|------------------|--------------------------------|---------------------------------------|---------|
| 120-4900 | Silicone | Neoprene / Nylon | Slip-On with Hook & Loop Close | <input type="checkbox"/> Black / Gray | S - XXL |
|-----------------|----------|------------------|--------------------------------|---------------------------------------|---------|

FOR PROFESSIONALS & ENTHUSIASTS

MECHANIC'S GLOVES

WITH TOUCH SCREEN CAPABILITY



▲ 120-MX2805



▲ 120-MX2820



▲ 120-MX2830



▲ 120-MX2840

**MAXIMUM SAFETY®
MECHANIC'S GLOVES**

- Synthetic leather palm provides dexterity and a good grip in dry and slightly oily applications
- Protection from heat, cold, cut and abrasions
- Stretch fabric back provides snug fit for increased grip and finger control
- Reinforced index finger for added durability

APPLICATIONS: Protects the Professional Mechanic or Enthusiast From Heat, Cold, Cuts and Abrasions

MAXIMUM SAFETY® MECHANIC'S GLOVES

| STYLE NUMBER | GRIP | BACK | CUFF | COLOR | SIZES |
|----------------------------|--------------------------|----------------------|----------------------------------|------------------|---------|
| 120-MX2805 | Amara® Synthetic Leather | Elastane / Polyester | Slip-On with Hook & Loop Closure | □ Black | S - XXL |
| 120-MX2820 | Amara® Synthetic Leather | Elastane / Polyester | Slip-On with Hook & Loop Closure | ■ Yellow / Black | S - XL |
| 120-MX2830 | Amara® Synthetic Leather | Elastane / Polyester | Slip-On with Hook & Loop Closure | ■ Blue / Black | S - XL |
| 120-MX2840 | Amara® Synthetic Leather | Elastane / Polyester | Slip-On with Hook & Loop Closure | ■ Red / Black | S - XL |



PROTECTS FROM HEAT, COLD, CUTS & ABRASIONS

HIGH PERFORMANCE GLOVES

LIFTING & SHOCK ABSORBING



MAXIMUM SAFETY® 122-AV14

- Good durability
- Half-finger for increased dexterity and sensitivity
- Reinforced palm to help absorb and dampen shock
- Mesh back for breathability and additional comfort

APPLICATIONS: *Lifting, Material Handling*



MAXIMUM SAFETY® 122-AV70

- Good durability
- Half-finger for increased dexterity and sensitivity
- Reinforced palm to help absorb and dampen shock
- Terry cloth back for breathability

APPLICATIONS: *Lifting, Material Handling*



MAXIMUM SAFETY® 122-AV71

- Half-finger for increased dexterity and sensitivity
- Reinforced palm to help absorb and dampen shock
- Lycra® construction for increased comfort
- Can be used as a glove liner

APPLICATIONS: *Lifting, Material Handling*

ERGONOMOMIC LIFTING GLOVES



MAXIMUM SAFETY® 122-169

- Good comfort and durability
- Reinforced palm to help absorb and dampen shock
- Leather driver's style

APPLICATIONS: *Lifting, Material Handling*



ENHANCED WRIST SUPPORT

▲ 122-AV20

▲ 122-AV40

MAXIMUM SAFETY® ANTI-VIBRATION LIFTING GLOVES

- Good durability
- Features heavy duty leather palm and knuckles
- Half-finger for increased dexterity and sensitivity
- Reinforced palm to help absorb and dampen shock
- Wraparound wrists for added support

APPLICATIONS: *Lifting, Material Handling*

MAXIMUM SAFETY LIFTING GLOVES

| STYLE NUMBER | GRIP | BACK | CUFF | COLOR | SIZES |
|--------------------------|---------------------------|---------------------------|---------------------|------------------|----------|
| 122-AV14 | Leather | Crocheted Cotton | Hook & Loop Closure | ■ Black | S - XXL |
| 122-AV70 | Sheepskin Leather | Stretch Fabric | Hook & Loop Closure | ■ Black / Gold | S - XXL |
| 122-AV71 | Goatskin Leather | Lycra® | Hook & Loop Closure | ■ Black | S - XXL |
| 122-169 | Top Grain Cowhide Leather | Top Grain Cowhide Leather | Slip-On | ■ Natural / Gray | XS - XXL |

MAXIMUM SAFETY ANTI-VIBRATION LIFTING GLOVES

| | | | | | |
|--------------------------|--------------------|--------|---------------------|----------------|---------|
| 122-AV20 | Heavy Duty Leather | Cotton | Hook & Loop Closure | ■ Black | S - XXL |
| 122-AV40 | Heavy Duty Leather | Cotton | Hook & Loop Closure | ■ Black / Gold | S - XXL |

**MAXIMUM
SAFETY**

DESIGNED TO
REDUCE
FATIGUE

HIGH PERFORMANCE GLOVES

UTILITY

GLOVES FOR UTILITY

MAXIMUM SAFETY® UTILITY GLOVES

| STYLE NUMBER | ANSI | EN 388 | FLAME RESISTANT | GRIP | LINED | CUFF | COLOR | SIZES |
|-----------------|------|--------|-----------------|---|------------|------------|-----------------|----------|
| 73-1703 | A3 | 3342 | Yes | FR Synthetic Leather | Kevlar® | Slip-On | ☐ Black | S - XXXL |
| 39-C1375 | --- | 2243 | No | Latex Crinkle | Unlined | Knit Wrist | ☐ Black | S - XL |
| 120-4800 | --- | 3121 | No | Goatskin Leather with PVC Diamond Patches | Thinsulate | Knit Wrist | ☑ Black / Brown | S - XXL |

LEATHER UTILITY GLOVES

| | | | | | | | | |
|-----------------|-----|------|-----|----------------------------|---------|---------|-----------|----------|
| 09-K3700 | A2 | 2241 | No | Top Grain Goatskin Leather | Kevlar® | Slip-On | ☐ Brown | S - XXXL |
| 73-2000 | --- | 3122 | Yes | FR Synthetic Leather | Unlined | Slip-On | ☐ Gray | S - XXL |
| 09-K3720 | --- | 2344 | No | Top Grain Goatskin Leather | Kevlar® | Slip-On | ■ Natural | M - XL |



ANSI
A3

MAXIMUM SAFETY® 73-1703

- Inherently FR Nomex® material used in construction of glove
- Kevlar® lined and stitched for light heat and cut protection
- Fourchettes between the fingers provide a better fit
- Double palm enhances comfort and protection
- Reinforced thumb joint provides added durability

APPLICATIONS: *Material Handling, Stamping, Grinding, Cut Resistance, Multitasking Where Welding Could Be Part of the Task*



MAXIMUM SAFETY® 39-C1375

- Seamless knit construction is comfortable and flexible
- Latex crinkle coating provides superior grip in dry and wet, non-oily conditions
- Ergonomic shaped finger pattern reduces hand fatigue
- Fabric back provides breathability and flexibility
- Launderable

APPLICATIONS: *Light Construction, Auto Repair, Manufacturing, Fabrication Landscaping*



WATERPROOF LINER

MAXIMUM SAFETY® 120-4800

- Provides high abrasion resistance and tactility
- 3M™ Thinsulate™ lining provides superior insulation without the bulk of fleece
- PVC diamond grip pattern on fingers and palm for enhanced grip
- Neoprene pad provides additional knuckle protection
- Breathable, waterproof liner keeps hands dry and comfortable
- Fourchettes between the fingers provide a better fit

APPLICATIONS: *Cold Weather Work, Petrochemical, Construction, Manufacturing, Mining, Fabrication*

MAXIMUM
SAFETY

ARC RATED GLOVES

ELECTRICAL



ELECTRICAL ARC RATED HAND PROTECTION

MAXIMUM SAFETY® ELECTRICAL ARC RATED GLOVES

| STYLE NUMBER | ANSI | EN 388 | EN 407 | CAL/CM² | FLAME RESISTANT | GRIP | LINED | CUFF | COLOR | SIZES |
|-----------------|------|--------|--------|---------|-----------------|----------------------------|---------|------------|------------------|----------|
| 09-K3750 | A2 | 3342 | --- | 28.5 | Yes | Top Grain Goatskin Leather | Kevlar® | Slip-On | ■ Natural | S - XXXL |
| 73-K1800 | A4 | 2542 | 41212 | 6.3 | Yes | Nitrile Smooth | --- | Knit Wrist | ■ Yellow / Black | S - XXL |
| 73-1700 | --- | 2332 | --- | 30 | Yes | Goatskin Leather | Kevlar® | Slip-On | ■ Black / Brown | S - XXL |



MAXIMUM SAFETY® 09-K3750

- Arc rated with high cut protection
- Kevlar® lined for light heat and cut protection
- Provides high abrasion resistance
- Top grain goatskin leather is soft, abrasion resistant and provides tactility
- Straight thumb is ergonomic, providing better dexterity

APPLICATIONS: *Material Handling, General Maintenance, Woodworking, Recycling*



MAXIMUM SAFETY® 73-K1800

- Arc rated with high cut protection
- Seamless knit aramid liner is comfortable and flexible
- Nitrile coated palm and finger tips for enhanced grip

APPLICATIONS: *Oil and Gas Protection Against Arc and Flash Fires*



MAXIMUM SAFETY® 73-1700

- Arc rated
- Kevlar® lined for light heat and cut protection
- Mechanics drivers style glove
- Goatskin palm provides comfort
- Aramid fiber back for additional heat protection
- Wing thumb increases comfort in open-handed work

APPLICATIONS: *Oil and Gas Protection Against Arc and Flash Fires*

COLD PROTECTION GLOVES

LATEX COATED SEAMLESS KNIT

KEEP YOUR HANDS WARM & DRY

MINI HAND WARMERS



▲ 399-HEATPACK

- Ideal size for our headwear and gloves
- Generates over 8 hours of warmth
- Heating can be suspended at any time by resealing the inserts in an airtight container



REMOVE FROM PACKAGE TO ACTIVATE



STARTS WORKING IN MINUTES



PROVIDES 8+ HOURS OF WARMTH

HEAT PACKS MINI HAND WARMERS

| STYLE NUMBER | QUANTITY |
|---------------------|-------------|
| 399-HEATPACK | 40 pair/box |



▶ POWERGRAB™ THERMO

- Latex MicroFinish® coating provides a superior grip in dry and wet, non-oily conditions
- Moisture wicking material to keep hands dry
- Fully coated thumb increases protection
- Stays flexible in cold weather

APPLICATIONS: Refrigerated Warehouses, Food Processing Facilities, Utilities, Construction, Outdoor Winter Tasks



▲ 41-1400

▲ 41-1405

▲ 41-1475

▲ 41-1430

ENHANCED PROTECTION

DOUBLE LINER

POWERGRAB™ THERMO

| STYLE NUMBER | EN 388 | COATING | COATING COVERAGE | COATING COLOR | LINER MATERIAL | LINER COLOR | CONSTRUCTION | GAUGE | SIZES |
|----------------|--------|--------------------|-----------------------------|---------------|----------------|-------------|----------------------|-------|---------|
| 41-1400 | 2231 | Latex MicroFinish® | Palm & Fingertips | ☐ Brown | Acrylic | ■ Orange | Coated Seamless Knit | 10 | S - XXL |
| 41-1405 | 1231 | Latex MicroFinish® | Palm & Fingertips | ☐ Brown | Acrylic | ■ Lime | Coated Seamless Knit | 10 | S - XXL |
| 41-1475 | 2121 | Latex MicroFinish® | Palm, Full Finger & Knuckle | ☐ Brown | Acrylic | ■ Orange | Coated Seamless Knit | 10 | S - XXL |
| 41-1430 | 3231 | Latex MicroFinish® | Palm & Fingertips | ☐ Brown | Acrylic/Nylon | ☐ Black | Coated Seamless Knit | 10 | S - XXL |

COLD PROTECTION GLOVES

COATED SEAMLESS KNIT



EN 388
4432



LATEX
FOAM CRINKLE
COATING

41-1420

- Latex foam crinkle coating provides a superior grip in dry and wet, non-oily conditions
- Moisture wicking material to keep hands dry
- Hi-Vis color for better visibility
- Stays flexible in cold weather

APPLICATIONS: *Refrigerated Warehouses, Food Processing Facilities, Utilities, Construction, Outdoor Winter Tasks*



EN 388
2342



ANSI
A3

LATEX
MICROFINISH®
COATING

POWERGRAB™ KEV THERMO 09-K1350

- Excellent grip in dry and slightly wet, non-oily conditions
- Fully coated thumb to increase wear
- Acrylic blended Kevlar® shell to provide warmth in cold environments

APPLICATIONS: *Ceramics, Glass Cutting, Metal Handling, General Maintenance, Cold Protection*

CUT RESISTANT

EXCELLENT INSULATION



EN 388
4432



NITRILE FOAM
COATING

41-1415

- Nitrile foam coating provides superior grip in dry, wet and oily applications
- Hi-Vis color for better visibility
- Quickly evaporates moisture from the skin

APPLICATIONS: *General Maintenance, Cold Protection*

DOUBLE-DIPPED



EN 388
3132



LATEX
FOAM CRINKLE
COATING

G-TEK® GP™ 41-1425

- Latex crinkle coating provides superior grip in wet and dry conditions
- Hi-Vis color makes product very easy to see
- Acrylic gloves provide economical cold weather protection

APPLICATIONS: *General Maintenance, Cold Protection*

ALSO CHECK OUT OUR COLD PROTECTION GLOVE STYLES BY MAXIMUM SAFETY®



MAXIMUM SAFETY



PAGE
110

Thinsulate
Mad Max™ Thermo
with Thinsulate™
120-4070

PAGE
117

Thinsulate
Insulated Professional
Workmans' Glove
120-4800

SEAMLESS KNIT COATED

| STYLE NUMBER | EN 388 | ANSI | COATING | COATING COVERAGE | COATING COLOR | LINER MATERIAL | LINER COLOR | CONSTRUCTION | GAUGE | SIZES |
|--------------|--------|------|--------------------|-----------------------------|--|---------------------------|---|----------------------|-------|---------|
| 41-1420 | 1221 | --- | Latex MicroFinish® | Palm & Fingertips | <input type="checkbox"/> Black | Acrylic | <input checked="" type="checkbox"/> Lime | Coated Seamless Knit | 10 | S - XL |
| 09-K1350 | 2342 | A3 | Latex MicroFinish® | Palm & Fingertips | <input checked="" type="checkbox"/> Brown | DuPont™ Kevlar® / Acrylic | <input checked="" type="checkbox"/> Yellow | Coated Seamless Knit | 10 | S - XXL |
| 41-1415 | 4432 | --- | Nitrile Foam | Palm, Full Finger & Knuckle | <input checked="" type="checkbox"/> Black / Blue | Polyester / Acrylic | <input checked="" type="checkbox"/> Hi-Vis Yellow | Coated Seamless Knit | 10 | S - XL |
| 41-1425 | 3132 | --- | Latex Crinkle | Palm & Fingertips | <input type="checkbox"/> Black | Acrylic | <input checked="" type="checkbox"/> Hi-Vis Yellow | Coated Seamless Knit | 10 | S - XXL |

COLD PROTECTION GLOVES

SEAMLESS KNIT GLOVES & LINERS / PVC COATED



4121

58-8650

- Special PVC blend that stays soft and flexible in cold applications
- Rough finish provides good grip in wet and dry applications
- Gauntlet cuff for additional forearm protection

APPLICATIONS: *Cold Environments, Fishing, Maintenance*



58-7313

- Foam insulation keeps hands warm and dry
- Liquid-proof
- Crystal grip provides excellent grip in wet applications
- Hi-Vis color for better visibility

APPLICATIONS: *Cold Environments, Handling Grease, Oils, Acids, Caustics, Solvents, Warehousing, Highway Construction, Traffic Control*



41-130

- Merino® Wool provides superior insulating properties even when wet, and withstands moderately high temperatures
- Great liner for use with Novax® electrical gloves
- Ambidextrous

APPLICATIONS: *Refrigeration, Utilities, Outdoor Winter Activities and Recreation, Food Processing, Construction*



GREAT LINER FOR NOVAX® ELECTRICAL GLOVES

41-001W

- Thermax® helps keep moisture away from the hands, keeping hands warm, dry and comfortable
- Can be used as a glove or as a glove liner in cold weather
- Extra softness for non-chafing comfort
- Ambidextrous

APPLICATIONS: *Refrigeration, Utilities, Outdoor Winter Activities and Recreation, Food Processing, Construction*



PVC GLOVES FOR COLD & WET CONDITIONS

SEAMLESS KNIT GLOVES AND LINERS

| STYLE NUMBER | MATERIAL | COLOR | GAUGE | WEIGHT | SIZES |
|-----------------|----------------------------------|-----------|-------|--------|----------|
| 41-005 | Polypropylene | Dark Blue | 13 | Light | XS - XL |
| 41-070 | 75% Wool, 25% Nylon | Natural | 7 | Medium | L |
| 41-075 | 75% Wool, 25% Nylon, Half-Finger | Natural | 7 | Medium | L |
| 41-010 | 100% Acrylic | Natural | 7 | Medium | XS, S, L |
| 41-013 | 100% Acrylic | Orange | 7 | Medium | XS, S, L |
| 41-011 | 100% Acrylic | Black | 7 | Medium | S - XL |
| 41-001 | Thermax® | Black | 13 | Light | M - L |
| 41-001NB | Thermax® | Navy Blue | 13 | Light | L |
| 41-001W | Thermax® | White | 13 | Light | L |
| 41-002 | Thermal Yarn / Lycra® | White | 13 | Light | L |
| 41-130 | Merino Wool | Black | 13 | Light | L |

PVC

| STYLE NUMBER | EN 388 | POLYMER | COLOR | CUFF | LENGTH | CONSTRUCTION | GRIP | LINING | SIZES |
|-----------------------------|--------|---------|---------------|------------|--------|--------------|---------|-----------|--------|
| 58-7303 | --- | PVC | Hi-Vis Orange | Knit Wrist | 11" | Supported | Smooth | Foam | Men's |
| 58-7304 | --- | PVC | Hi-Vis Orange | Straight | 12" | Supported | Smooth | Foam | Men's |
| 58-7305 | --- | PVC | Hi-Vis Orange | Safety | 11" | Supported | Smooth | Foam | Men's |
| 58-7313 | --- | PVC | Hi-Vis Orange | Knit Wrist | 11" | Supported | Crystal | Foam | Men's |
| 58-7315 | --- | PVC | Hi-Vis Orange | Safety | 11" | Supported | Crystal | Foam | Men's |
| SPECIALTY PVC BLENDS | | | | | | | | | |
| 58-8650 | 4121 | PVC | Brown | Straight | 10" | Supported | Rough | Interlock | S - XL |
| 58-8651 | 4121 | PVC | Brown | Straight | 12" | Supported | Rough | Interlock | S - XL |

COLD PROTECTION GLOVES

INSULATED LEATHER

INSULATED LEATHER

TOP GRAIN COWHIDE LEATHER DRIVERS

| STYLE NUMBER | HIDE | GRADE | INSULATION | PATTERN | THUMB | BACK | COLOR | CUFF | SIZE |
|------------------------|---------|---------|-----------------|---------|----------|------|-------|---------|---------|
| 77-218 | Cowhide | Premium | White Thermal | --- | Straight | --- | --- | Slip-On | S - XL |
| 77-265 | Cowhide | Premium | White Thermal | --- | Keystone | --- | --- | Slip-On | S - XL |
| 77-268 | Cowhide | Premium | Red Thermal | --- | Keystone | --- | --- | Slip-On | S - XL |
| 77-208 | Cowhide | Premium | Red Foam | --- | Straight | --- | --- | Slip-On | S - XXL |
| 77-269 | Cowhide | Premium | 3M™ Thinsulate™ | --- | Keystone | --- | --- | Slip-On | S - XL |
| 77-298 | Cowhide | Premium | Fleece Pile | --- | Keystone | --- | --- | Slip-On | S - XXL |

TOP GRAIN PIGSKIN LEATHER DRIVERS

| | | | | | | | | | |
|------------------------|---------|---------|-----------------|-----|----------|-----|-----|---------|--------|
| 77-418 | Pigskin | Premium | White Thermal | --- | Straight | --- | --- | Slip-On | S - XL |
| 77-468 | Pigskin | Premium | Red Thermal | --- | Keystone | --- | --- | Slip-On | S - XL |
| 77-469 | Pigskin | Premium | 3M™ Thinsulate™ | --- | Keystone | --- | --- | Slip-On | S - XL |

SPLIT COWHIDE LEATHER DRIVERS

| | | | | | | | | | |
|--------------------------|---------|---------|-----------------|-----|----------|-----|-----|---------|---------|
| 77-238 | Cowhide | Regular | White Thermal | --- | Straight | --- | --- | Slip-On | S - XL |
| 77-289TL | Cowhide | Regular | 3M™ Thinsulate™ | --- | Keystone | --- | --- | Slip-On | S - XXL |
| 77-289 | Cowhide | Regular | Fleece Pile | --- | Keystone | --- | --- | Slip-On | S - XXL |

SPLIT COWHIDE LEATHER PALM

| | | | | | | | | | |
|--------------------------|---------|---------|-------------|------|------|--------|---------------|--------------------|--------|
| 78-7863B | Cowhide | Regular | Fleece Pile | Gunn | Wing | Canvas | Blue / Yellow | Safety, Rubberized | L - XL |
| 78-7825 | Cowhide | Regular | Red Foam | Gunn | Wing | Canvas | Gray / Red | Safety, Rubberized | L - XL |

TOP GRAIN PIGSKIN LEATHER PALM

| | | | | | | | | | |
|---------------------------|---------|---------|-----------------|------|----------|--------|--------------|--------------------|--------|
| 78-3927 | Pigskin | Premium | 3M™ Thinsulate™ | Gunn | Straight | Canvas | Blue / Green | Safety, Rubberized | M - XL |
| 78-3927KW | Pigskin | Premium | 3M™ Thinsulate™ | Gunn | Straight | Canvas | Blue / Green | Knit Wrist | M - XL |

TYPES OF LINING

WHITE THERMAL

BASIC INSULATION

RED THERMAL

DENSER, HEAVIER FABRIC FOR BETTER INSULATION

RED FOAM

ENHANCED INSULATION & MOISTURE PROTECTION

FLEECE PILE

EXTRA THICK FOR SUPERIOR WARMTH

3M™ THINSULATE™

SUPERIOR WARMTH WITHOUT BULK



WHITE THERMAL LINING



77-218

- White thermal liner provides insulation
- Straight thumb increases comfort in close-fisted work

APPLICATIONS: Cold Storage, Construction, Farming



3M™ THINSULATE™ LINING



77-469

- 3M™ Thinsulate™ liner for superior warmth without the bulk
- Keystone thumb is ergonomic, providing better dexterity
- Breathable for added comfort

APPLICATIONS: Cold Storage, Construction, Farming



FLEECE PILE LINING



78-7863B

- Fleece pile lining provides superior warmth
- Fabric back provides breathability and flexibility
- Rubberized safety cuff for easy donning and doffing, and water resistance

APPLICATIONS: Cold Weather Farming, Construction, Machine Operation and Refrigeration

HANDLE THE HEAT



RED VIPER™ 73-7015

- One piece back for extended life
- Fully welted to protect seams from abrasions
- Wing thumb increases comfort in open-handed work
- Reinforced thumb joint for additional wear protection

APPLICATIONS: *Welding and Hot, Heavy Material Handling*



BLUE BISON™ 73-7250

- One piece back for extended life
- Fully welted
- Cotton foam lining provides additional heat protection while absorbing moisture
- Double reinforced palm and thumb for increased durability and protection
- Kevlar® stitched for strength and burn resistance

APPLICATIONS: *Welding and Hot, Heavy Material Handling*

WELDING GLOVES

| STYLE NUMBER | HIDE | GRADE | STITCHING | COLOR | LINING | CUFF | REINFORCED THUMB JOINT | SIZES |
|-------------------|---------------|-----------------|-----------|--------------|-------------|----------|------------------------|----------------|
| 73-888A | Split Cowhide | Economy | Nylon | Gray | Cotton | Straight | No | L |
| 73-888 | Split Cowhide | Shoulder | Nylon | Gray | Cotton | Straight | No | L |
| 73-888LHO | Split Cowhide | Shoulder | Nylon | Gray | Cotton | Straight | No | L (Left Hand) |
| 73-888RHO | Split Cowhide | Shoulder | Nylon | Gray | Cotton | Straight | No | L (Right Hand) |
| 73-7088 | Split Cowhide | Shoulder | Nylon | Golden Brown | Cotton | Straight | No | L |
| 73-7015A | Split Cowhide | Shoulder | Nylon | Russet | Cotton | Straight | No | L |
| 73-7018 | Split Cowhide | Shoulder | Kevlar® | Blue | Cotton Foam | Straight | Yes | L |
| 73-7085 | Split Cowhide | Shoulder | Kevlar® | Brown | Cotton Foam | Straight | Yes | L |
| 73-7007 | Split Cowhide | Select Shoulder | Kevlar® | Blue | Cotton | Straight | Yes | L |
| 73-7007LHO | Split Cowhide | Select Shoulder | Kevlar® | Blue | Cotton | Straight | Yes | L (Left Hand) |
| 73-7007RHO | Split Cowhide | Select Shoulder | Kevlar® | Blue | Cotton | Straight | Yes | L (Right Hand) |
| 73-7015 | Split Cowhide | Select Shoulder | Kevlar® | Russet | Cotton | Straight | Yes | L |
| 73-7080 | Split Cowhide | Side Split | Kevlar® | Blue | Cotton Foam | Straight | Yes | L |
| 73-7150 | Split Cowhide | Side Split | Kevlar® | Brown | Cotton Foam | Straight | Yes | L |
| 73-7250 | Split Cowhide | Side Split | Kevlar® | Blue | Cotton Foam | Straight | Yes | L |

HEAT PROTECTION GLOVES

LEATHER WELDING & FOUNDRY

MIG TIG WELDING & FOUNDRIES



AVAILABLE IN LHO & RHO

75-320

- Unlined palm provides dexterity
- Kevlar® stitched for strength and burn resistance
- Split leather gauntlet cuff provides additional forearm protection
- Straight thumb increases comfort in close-fisted work

APPLICATIONS: Mig Tig, Welding, Metal Fabrication, Automotive



KEVLAR® STITCHING

74-SC7104

- Heavier construction for increased durability
- Leather gauntlet cuff provides additional forearm protection
- Thick wool lining for thermal insulation
- Straight thumb increases comfort in close-fisted work

APPLICATIONS: Foundries and Hot Metal Handling

MIG TIG WELDER'S GLOVES

| STYLE NUMBER | HIDE | GRADE | STITCHING | COLOR | LINING | CUFF | SIZES |
|----------------------------|--------------------|---------|-----------|---------------|---------|-----------------------------|---------------------|
| 75-2022 | Top Grain Cowhide | Premium | Kevlar® | ■ Natural | Unlined | Split Leather Band Top | M - XL |
| 75-2026 | Top Grain Cowhide | Premium | Kevlar® | ■ Natural | Unlined | Leather Gauntlet | M - XL |
| 75-320 | Top Grain Pigskin | Premium | Kevlar® | ■ Natural | Unlined | Split Leather Gauntlet | S - XL |
| 75-320/LHO | Top Grain Pigskin | Premium | Kevlar® | ■ Natural | Unlined | Split Leather Gauntlet | M - XL (Left Hand) |
| 75-320/RHO | Top Grain Pigskin | Premium | Kevlar® | ■ Natural | Unlined | Split Leather Gauntlet | M - XL (Right Hand) |
| 75-4904 | Top Grain Goatskin | Premium | Kevlar® | ■ Gray | Unlined | Goatskin Band Top Cuff | S - XL |
| 75-4854 | Top Grain Goatskin | Premium | Kevlar® | ■ Gray / Blue | Unlined | Blue Cowhide Split Gauntlet | XS - XL |

FOUNDRY GLOVES

| | | | | | | | |
|---------------------------|---------------|---------|---------|--------|------|-----------------------------|---|
| 74-SC7104 | Split Cowhide | Premium | Kevlar® | ■ Gray | Wool | Split Leather Gauntlet Cuff | L |
|---------------------------|---------------|---------|---------|--------|------|-----------------------------|---|

TERRYCLOTH LOOP-OUT DESIGN



94-928G

- Multi-layer construction provides comfort, insulation, and superior heat protection
- Burlap lining creates an air pocket providing increased heat protection
- Knuckle strap for enhanced protection
- Gauntlet cuff for additional forearm protection

APPLICATIONS: *Forging, Hot Metal Handling, Castings, Molds and other operations that require heat protection*



42-C700

- Seamless construction offers increased comfort and breathability
- Provides comfortable resistance to cuts, abrasions and heat
- Loop out design helps protect against intermittent contact with hot surfaces
- Ambidextrous pattern

APPLICATIONS: *Operations that require heat and abrasion protection*



42-853

- Seamless construction offers increased comfort and breathability
- Provides comfortable resistance to cuts, abrasions and heat
- Loop out design helps protect against intermittent contact with hot surfaces
- 13" length provides additional forearm protection
- Double-insulated for excellent thermal protection

APPLICATIONS: *Food Service, Bakeries*

FABRIC HOT MILL GLOVES

| STYLE NUMBER | WEIGHT | COLOR | LAVERS | CUFF | BURLAP | SIZES |
|-------------------------|--------|---------------------|--------|-------------------|--------|-------|
| 94-924 | 24 oz. | ■ Natural | Two | Band Top | No | Men's |
| 94-924I | 24 oz. | ■ Natural | Two | Band Top | No | Men's |
| 94-924R | 24 oz. | ■ Natural | Two | Band Top | No | Men's |
| 94-924G | 24 oz. | ■ Natural | Two | Starched Gauntlet | No | Men's |
| 94-928 | 28 oz. | ■ Natural | Three | Band Top | Yes | Men's |
| 94-928I | 28 oz. | ■ Natural | Three | Band Top | Yes | Men's |
| 94-928G | 28 oz. | ■ Natural | Three | Starched Gauntlet | Yes | Men's |
| 94-930 | 30 oz. | ■ Natural | Three | Band Top | No | Men's |
| 94-932 | 32 oz. | ■ Natural | Three | Band Top | Yes | Men's |
| 94-932G | 32 oz. | ■ Natural | Three | Starched Gauntlet | Yes | Men's |
| 94-934 | 34 oz. | ■ Natural / ■ Denim | Three | Band Top | No | Men's |

TERRYCLOTH GLOVES

| STYLE NUMBER | WEIGHT | COLOR | CUFF | SIZES |
|-------------------------|--------|-----------|---------------|-------|
| 42-C700 | 24 oz. | ■ Natural | Knit Wrist | S & L |
| 42-C750 | 24 oz. | ■ Gray | Knit Wrist | L |
| 42-C713 | 18 oz. | ■ Natural | Knit Wrist | S & L |
| 42-C753 | 18 oz. | ■ Gray | Knit Wrist | S & L |
| 42-C920 | 32 oz. | ■ Brown | Gauntlet Cuff | L |

TERRYCLOTH SLEEVES

| | | | | |
|------------------------|--------------|-----------|------------|-----|
| 42-215 | Heavy Weight | ■ Natural | Knit Wrist | 15" |
| 42-329 | Heavy Weight | ■ Natural | Open | 19" |

TERRYCLOTH BAKERS PADS & MITTS

| | | | | |
|------------------------|---------------------|-----------|---------------|-----------|
| 42-811 | Heavy Weight, 2-Ply | ■ Natural | Pad | 10" x 11" |
| 42-857 | Heavy Weight, 2-Ply | ■ Natural | Gauntlet Cuff | L |
| 42-853 | Heavy Weight, 2-Ply | ■ Natural | Gauntlet Cuff | L |

PROTECTS FROM INTERMITTENT CONTACT WITH HOT SURFACES

HEAT PROTECTION GLOVES

COATED FABRIC HOT MILL

HOT MILL SEAMLESS KNITS



▲ 43-500



▲ 43-502

▶ HOT MILL GLOVES

- EverGrip™ nitrile coating resists melting while providing improved grip
- Double-layered for increased heat protection
- Ambidextrous

APPLICATIONS: *Glass Handling, Hot Metal Handling, Forging Operations*



▲ 43-858



▶ 43-851

- Kevlar® / Preox blend provides cut, abrasion and heat protection
- Flame resistant
- Silagrip coating for enhanced grip and resists melting
- Ambidextrous
- Meets CFR 1910.269 standards
- Complies with NFPA 70E standards

APPLICATIONS: *Glass Handling, Hot Metal Handling, Forging Operations*

HOT MILL KNIT GLOVES

| STYLE NUMBER | COATING | COATING COVERAGE | COATING COLOR | LINER MATERIAL | LINER COLOR | CONSTRUCTION | CUFF | WEIGHT | SIZES |
|---------------|-------------------|------------------|---------------|---|-------------|-------------------------------------|------------|--------|----------|
| 43-502 | EverGrip™ Nitrile | Single-Sided | ■ Rust | 100% Cotton | ■ Natural | Coated Double-Layered Seamless Knit | Open | 24 oz. | S, L |
| 43-500 | Uncoated | Uncoated | Uncoated | 100% Cotton | ■ Natural | Coated Double-Layered Seamless Knit | Open | 24 oz. | S, L |
| 43-802 | EverGrip™ Nitrile | Single-Sided | ■ Rust | 100% Cotton | ■ Natural | Coated Double-Layered Seamless Knit | Open | 32 oz. | S, L |
| 43-552 | EverGrip™ Nitrile | Single-Sided | ■ Rust | Kevlar® / Cotton Blend | ■ Yellow | Coated Double-Layered Seamless Knit | Open | 24 oz. | S, L |
| 38-720 | EverGrip™ Nitrile | Double-Sided | ■ Rust | Cotton / Polyester | ■ Natural | Coated Seamless Knit | Knit Wrist | Heavy | S, L |
| 43-850 | Uncoated | Uncoated | Uncoated | Kevlar® / Preox Blend, Terry Cotton Lined | ■ Green | Coated Double-Layered Seamless Knit | Open | 32 oz. | L |
| 43-851 | Silagrip | Double-Sided | □ Black | Kevlar® / Preox Blend, Terry Cotton Lined | ■ Green | Coated Double-Layered Seamless Knit | Open | 32 oz. | L |
| 43-858 | Uncoated | Uncoated | Uncoated | Kevlar® / Preox Blend, Terry Cotton Lined | ■ Green | Coated Double-Layered Seamless Knit | Open | 32 oz. | S, L, XL |
| 43-859 | Silagrip | Double-Sided | □ Black | Kevlar® / Preox Blend, Terry Cotton Lined | ■ Green | Coated Double-Layered Seamless Knit | Open | 32 oz. | L |

FIREFIGHTING GLOVES



SMOKESCREEN™
910-P735

- Superior protection and thermal resistance
- Palm provides good grip with abrasion resistance, and remains soft after repeated use and laundering
- Rounded fingertips
- Formed knuckle guard for flexibility, grip and less hand fatigue
- Heavy duty ½" elastic zigzag around the entire glove at wrist

APPLICATIONS: *Structural Firefighting*



SMOKESHOW™
910-P775

- Superior protection and thermal resistance
- Palm provides good grip with abrasion resistance, and remains soft after repeated use and laundering
- Rounded fingertips
- Kangaroo knuckles and fourchettes on all sides of each finger & thumb
- Formed knuckle guard for flexibility, grip and less hand fatigue
- Heavy duty ½" elastic zigzag around the entire glove at wrist

APPLICATIONS: *Structural Firefighting*

STRUCTURAL FIREFIGHTING GLOVES

| STYLE NUMBER | NFPA 1971 | BACK | PALM | INSIDE | OUTSIDE | INSERT | STITCHING | COLOR | SIZES |
|-----------------|-----------|----------|------------------------|--------------------------|--------------------------------|-----------|-----------|----------------|--------|
| 910-P735 | Yes | Elk Skin | Split Cowhide | 100% Kanecaron Fleece | 50% Kanecaron 50% Cotton Scrim | PYROTECT® | Kevlar® | ☑ Gold / Black | S - XL |
| 910-P775 | Yes | Elk Skin | Eversoft Split Cowhide | 35% Kevlar® / 65% Nomex® | --- | PYRO-PRO™ | Kevlar® | ☐ Black | S - XL |

SUPERIOR PROTECTION & THERMAL RESISTANCE

EMERGENCY RESPONDER GLOVES

EXTRICATION & RESCUE

EXTRICATION GLOVES

MELT-RESISTANT FINGERTIPS



AUTO X™

- Fingertips won't melt and will withstand contact with hot materials up to 212°F (100°C)
- Puncture-resistant palm pads
- Kevlar® stitching
- Abrasion-resistant fingers/knuckles
- Maintains grip when wet and does not harden after drying

APPLICATIONS: *Emergency Rescue Situations Requiring Cut Protection, Heat Resistance and Close-Range Dexterity*



AUTO X™ PLUS 911-AX9P

- Includes a breathable vapor barrier, making the gloves bloodborne pathogen resistant

APPLICATIONS: *Emergency Rescue Situations Requiring Cut Protection, Heat Resistance and Close-Range Dexterity*

AUTO X™ EXTRICATION GLOVE

| STYLE NUMBER | PALM | BARRIER | COLOR | SIZES |
|-------------------------|--------------------------|---------|----------------|--------|
| 911-AX9 | Polyurethane & Synthetic | None | Orange / Black | S - XL |

AUTO X™ PLUS EXTRICATION GLOVE

| | | | | |
|--------------------------|--------------------------|-------------------------------|----------------|--------|
| 911-AX9P | Polyurethane & Synthetic | PTFE Breathable Vapor Barrier | Orange / Black | S - XL |
|--------------------------|--------------------------|-------------------------------|----------------|--------|

SERVE & PROTECT



▲ 130-600WM



▲ 130-650BM

100% STRETCH NYLON DRESS GLOVE

- Constructed in full fashion pattern with fourchettes and set-in thumbs for a tailored fit
- Three lines of raised stitching on back

APPLICATIONS: *For Formal Occasions by Police, Firemen, Waiters, Marching Bands, Military, Pallbearers*

CABARET™ - 100% STRETCH NYLON DRESS GLOVE

| STYLE NUMBER | COLOR | CUFF STYLE | SIZES |
|--------------|---------|--------------|---------|
| 130-600WM | ■ White | Open Cuff | Men's |
| 130-600WL | ■ White | Open Cuff | Ladies' |
| 130-650WM | ■ White | Snap Closure | Men's |
| 130-650WL | ■ White | Snap Closure | Ladies' |
| 130-650BM | □ Black | Snap Closure | Men's |

PARADE & UNIFORM GLOVES

COTTON DRESS

100% COTTON - THAT EXTRA TOUCH



▲ [130-100WM](#)



▲ [130-100GM](#)



DOTTED PALM

▲ [130-100WMPD](#)

CABARET™ - 100% COTTON DRESS GLOVE

| STYLE NUMBER | COLOR | CUFF STYLE | PALM | RAISED STITCHING | SIZES |
|-----------------------------|---------|--------------|----------------|------------------|---------|
| 130-100WM | ■ White | Open Cuff | Standard | With | S - XL |
| 130-100GM | □ Gray | Open Cuff | Standard | With | Men's |
| 130-150WM | ■ White | Snap Closure | Standard | With | S - XL |
| 130-100WMPD | ■ White | Open Cuff | Plastic Dotted | With | S - XL |
| 130-100WMNZ | ■ White | Open Cuff | Standard | Without | XS - XL |

MEDIUM WEIGHT TWO-PIECE AMBIDEXTROUS COTTON GLOVE

| STYLE NUMBER | COLOR | HEM STYLE | SIZES |
|-------------------------|---------|-------------------|---------|
| 97-520R | ■ White | Rolled | Men's |
| 97-520H | ■ White | Overlock Stitched | Men's |
| 97-520 | ■ White | Unhemmed | Men's |
| 97-521 | ■ White | Unhemmed | Ladies' |

FUNDAMENTALS OF **ARM PROTECTION**

WHEN WEARING CUT RESISTANT GLOVES, ALSO CONSIDER ARM PROTECTION TO EXTEND YOUR SAFETY COVERAGE AND PROTECT AGAINST OTHER POTENTIAL INJURIES. WHETHER YOU HANDLE LARGE AND/OR SHARP OBJECTS, ARE EXPOSED TO SPARKS, OR JUST NEED TO HAVE YOUR FOREARMS COVERED, PROTECTIVE SLEEVES CAN PROVIDE VARIOUS SOLUTIONS TO MEET YOUR SAFETY NEEDS.

APPLICATIONS

The most common application need for arm protection is **cut resistance**. In addition to **cut protection**, you can also achieve options that provide:

- **Maximum comfort**
- **Heat protection**
- **Food handling Capabilities**
- **Arc-rated protection**

Several customizable options are also available to help maximize protection by ensuring the sleeve stays in place as consistently as possible.

- Options such as **thumb holes** or **thumb slots** can help hold the sleeve up to the heel of your hand.
- Options can also help hold the sleeve up on your arm, such as **elastic bands** or **hook and loop closures**.

PRODUCTION

PIP manufactures sleeves in our facilities in Bluffton, IN and Chaska, MN, and we take pride in providing what we consider to be the most comprehensive offering of arm protection. And, because we manufacture these great products domestically, we have the ability to **custom make sleeves** for your particular application. See Page 146 for more details.

132 SMART-FIT™ TECHNOLOGY SLEEVES

134 FORM-FIT SEAMLESS KNIT SLEEVES

141 DUO-PRO™

142 LOOSE FITTING SLEEVES

144 SPECIALTY APPLICATIONS SLEEVES

146 CUSTOM SLEEVES

ARM PROTECTION

SMART FIT™ TECHNOLOGY SLEEVES

ONE-SIZE-FITS-ALL COMFORT



QUICK TUG
ADJUSTING KNIT

SMART-FIT™ ONE-SIZE-FITS-ALL

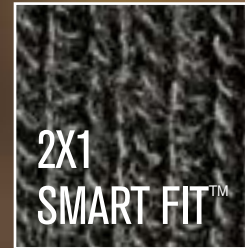

2x1 KNIT SMART FIT™ SLEEVE

A one size fits all technology. Smart Fit™ technology provides workers of all arm sizes to wear the same size sleeve and enjoy comfortable, form-fitting all-day protection.



STRETCH TO FIT ANY SIZE

Whether large or small, Smart Fit™ is designed to cover and protect the most commonly exposed areas of a worker's arm. Worn on a bare arm, or over layers, a single sleeve is right for most jobs.

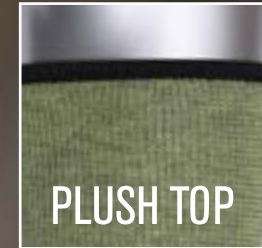

PLUSH TOP OPTION

Only Smart Fit™ sleeves are available with a plush top cuff option that comfortably and securely fits without the need to fasten or adjust.



SMART FIT™ TECHNOLOGY SLEEVES

ONE-SIZE-FITS-ALL COMFORT



ANSI
A4

KUT GARD® SMART FIT™ TECHNOLOGY
[10-21KVACPMBK18-ET](#)

ANSI
A4

KUT GARD® SMART FIT™ TECHNOLOGY
[15-21KVBK18TH](#)

ANSI
A4

KUT GARD® SMART FIT™ TECHNOLOGY
[15-21KVBK18](#)

ANSI
A3

KUT GARD® SMART FIT™ TECHNOLOGY
[10-21HACPNY18-ET](#)

ANSI
A3

KUT GARD® SMART FIT™ TECHNOLOGY
[20-21DACP18-ET](#)

ANSI
A2

KUT GARD® SMART FIT™ TECHNOLOGY
[15-21PRIBPS18-ET](#)

ACP™ WITH ARAMID ENGINEERED YARNS
CUT AND HEAT RESISTANT

ACP™ WITH HPPE ENGINEERED YARNS
CUT & COOLER COMFORT

PRITEX™ YARNS WITH ANTIMICROBIAL
LIGHT ABRASION RISK -
COOLER COMFORT SLEEVE

KUT GARD® SMART FIT™ TECHNOLOGY

| STYLE NUMBER | ASTM | MATERIAL | CONSTRUCTION | PLY | TOP CUFF | BOTTOM CUFF | COLOR | STANDARD LENGTH |
|------------------------------------|------|--------------------------------|--------------------------|-----|----------|---------------|----------------|-----------------|
| 10-21KVACPMBK18-ET | A4 | ACP™ / Kevlar® Blend | Smart Fit™ Seamless Knit | 1 | Serged | Thumb Elastic | Yellow / Black | 18" |
| 15-21KVBK18TH | A4 | ACP™ / Kevlar® / Pritex™ Blend | Smart Fit™ Seamless Knit | 1 | Serged | Thumb Hole | Yellow / Black | 18" |
| 15-21KVBK18 | A4 | ACP™ / Kevlar® / Pritex™ Blend | Smart Fit™ Seamless Knit | 1 | Serged | Straight | Yellow / Black | 18" |
| 10-21HACPNY18-ET | A3 | ACP™ / Kevlar® Blend | Smart Fit™ Seamless Knit | 1 | Serged | Thumb Elastic | Neon Yellow | 18" |
| 10-21KVACPM18-ET | A5 | ACP™ / Kevlar® Blend | Smart Fit™ Seamless Knit | 1 | Serged | Thumb Elastic | Yellow / Black | 18" |
| 10-21KVHACP18TH | A3 | ACP™ / Kevlar® Blend | Smart Fit™ Seamless Knit | 1 | Serged | Thumb Hole | Yellow | 18" |
| 10-21ACPCB18TH | A3 | ACP™ / Kevlar® with Cotton | Smart Fit™ Seamless Knit | 1 | Serged | Thumb Hole | Green | 18" |
| 20-21DACP18-ET | A3 | ACP™ / Dyneema® Blend | Smart Fit™ Seamless Knit | 1 | Serged | Thumb Elastic | Gray | 18" |
| 15-21PRIBPS18-ET | A2 | Pritex™ | Smart Fit™ Seamless Knit | 1 | Serged | Thumb Elastic | Black | 18" |
| 15-21PRIWPS18-ET | A2 | Pritex™ | Smart Fit™ Seamless Knit | 1 | Serged | Thumb Elastic | White | 18" |

Replace standard 18" length with any custom length from 10" - 24"

FORM-FIT SEAMLESS KNIT SLEEVES

SECURE CLOSE-TO-SKIN COMFORT



CUT RESISTANT
HEAT & SPARK PROPERTIES

2X THE CUT PROTECTION



10-KA24SCTOT

- Excellent cut protection
- Light heat protection
- 2-ply for additional wear protection

APPLICATIONS: Sheet Metal and Stamping, Glass Handling, Assembly, Plastic Molding, Automotive



ACP™ Technology offers an increase in overall performance and value, compared to traditional Para-Aramid products. ACP™ provides excellent abrasion and cut resistance for lower cost per use. ACP™ Technology sleeves are 100% silicone free.

KUT GARD® ACP™ TECHNOLOGY & DUPONT™ KEVLAR®

| STYLE NUMBER | ASTM | MATERIAL | CONSTRUCTION | PLY | COLOR | STANDARD LENGTH |
|------------------------------|------|----------------------|---|-----|-------------|-----------------|
| 10-KA18 | A5 | ACP™ / Kevlar® Blend | Seamless Knit | 2 | Green | 18" |
| 10-KA18CL | A5 | ACP™ / Kevlar® Blend | Seamless Knit, with Cotton Liner | 2 | Green | 18" |
| 10-KA18KL | A5 | ACP™ / Kevlar® Blend | Seamless Knit, with DuPont™ Kevlar® Liner | 2 | Green | 18" |
| 10-KA24SCTOT | A4 | ACP™ / Kevlar® Blend | Seamless Knit | 2 | Green | 24" |
| 10-KANY18 | A5 | ACP™ / Kevlar® Blend | Seamless Knit | 2 | Neon Yellow | 18" |
| 10-KANY18CL | A5 | ACP™ / Kevlar® Blend | Seamless Knit, with Cotton Liner | 2 | Neon Yellow | 18" |
| 10-KANY18KL | A5 | ACP™ / Kevlar® Blend | Seamless Knit, with DuPont™ Kevlar® Liner | 2 | Neon Yellow | 18" |
| 10-KANO18 | A5 | ACP™ / Kevlar® Blend | Seamless Knit | 2 | Neon Orange | 18" |
| 10-KANO18CL | A5 | ACP™ / Kevlar® Blend | Seamless Knit, with Cotton Liner | 2 | Neon Orange | 18" |
| 10-KANO18KL | A5 | ACP™ / Kevlar® Blend | Seamless Knit, with DuPont™ Kevlar® Liner | 2 | Neon Orange | 18" |
| 10-KANP18 | A5 | ACP™ / Kevlar® Blend | Seamless Knit | 2 | Neon Pink | 18" |
| 10-KANP18CL | A5 | ACP™ / Kevlar® Blend | Seamless Knit, with Cotton Liner | 2 | Neon Pink | 18" |
| 10-KANP18KL | A5 | ACP™ / Kevlar® Blend | Seamless Knit, with DuPont™ Kevlar® Liner | 2 | Neon Pink | 18" |
| 10-KA18S | A3 | ACP™ / Kevlar® Blend | Seamless Knit | 1 | Green | 18" |
| 10-KANY18S | A3 | ACP™ / Kevlar® Blend | Seamless Knit | 1 | Neon Yellow | 18" |
| 10-KANO18S | A3 | ACP™ / Kevlar® Blend | Seamless Knit | 1 | Neon Orange | 18" |
| 10-KANP18S | A3 | ACP™ / Kevlar® Blend | Seamless Knit | 1 | Neon Pink | 18" |

Replace standard 18" length with any custom length from 10" - 24"

FORM-FIT SEAMLESS KNIT SLEEVES

SECURE CLOSE-TO-SKIN COMFORT



CUT & HEAT RESISTANCE
FOR MAXIMUM PROTECTION

FORM-FIT SEAMLESS KNIT SLEEVES

SECURE CLOSE-TO-SKIN COMFORT



TRUSTED & PROVEN MAXIMUM CUT RESISTANCE



**KUT GARD®
MADE WITH KEVLAR®
10-KS18**

- High cut protection
- Light heat protection
- 2-ply for additional wear protection

APPLICATIONS: *Glass Operations,
Metal Stamping, Sheet Metal,
Automotive, Construction*



**KUT GARD®
MADE WITH KEVLAR®
10-BKDS18**

- High cut protection
- Light heat protection
- Dark color hides dirt
- 2-ply for additional wear protection

APPLICATIONS: *Glass Operations,
Metal Stamping, Sheet Metal,
Automotive, Construction*



Sleeves with DuPont™ Kevlar® provide excellent cut protection and protection from light heat for the wrists and arms. Available in single-ply or double-ply for added protection. Cotton inner ply styles offers added comfort. MTO options available for all sleeves in any length.

KUT GARD® MADE WITH KEVLAR®

| STYLE NUMBER | ASTM | MATERIAL | CONSTRUCTION | PLY | COLOR | STANDARD LENGTH |
|------------------|------|-----------------|-----------------------------------|-----|----------|-----------------|
| 10-KS18 | A3 | DuPont™ Kevlar® | Seamless Knit | 2 | ■ Yellow | 18" |
| 10-KS18CL | A3 | DuPont™ Kevlar® | Seamless Knit, 1-Ply Cotton Liner | 2 | ■ Yellow | 18" |
| 10-BKDS18 | A3 | DuPont™ Kevlar® | Seamless Knit | 2 | □ Black | 18" |
| 10-KS18S | A2 | DuPont™ Kevlar® | Seamless Knit | 1 | ■ Yellow | 18" |
| 10-BKS18 | A2 | DuPont™ Kevlar® | Seamless Knit | 1 | □ Black | 18" |

Replace standard 18" length with any custom length from 10" - 24"

FORM-FIT SEAMLESS KNIT SLEEVES

SECURE CLOSE-TO-SKIN COMFORT



UNPARALLELED
COMFORT & COOLNESS
MAXIMUM CUT RESISTANCE

FORM-FIT SEAMLESS KNIT SLEEVES

SECURE CLOSE-TO-SKIN COMFORT

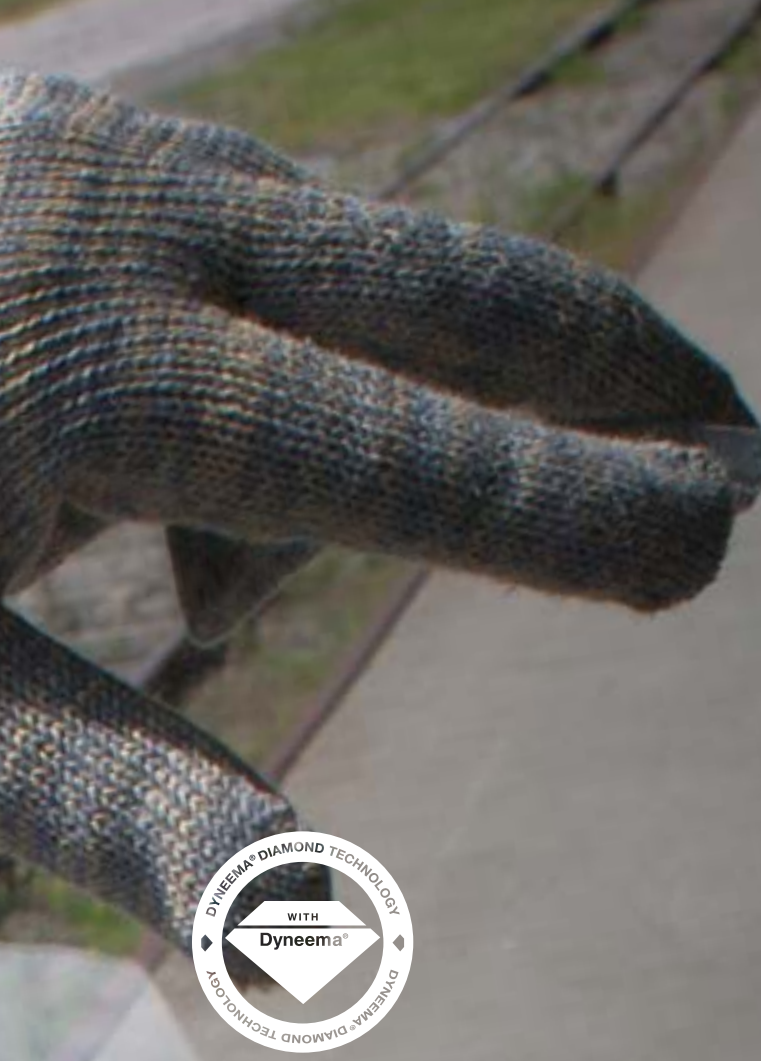

Sleeves made with Dyneema® Technology offer unparalleled comfort and coolness, while providing cut and abrasion resistance.



ANSI
A6

**KUT GARD®
WITH DYNEEMA®
20-DA4210**

- Excellent cut resistance to protect against minor cuts and scrapes
- Exceptional comfort and fit

APPLICATIONS: *Automotive, Plastic Molding, Glass Handling and Metal Stamping*



ANSI
A4

**KUT GARD®
WITH DYNEEMA®
20-DAPB22TOV**

- Excellent cut resistance to protect against minor cuts and scrapes
- Exceptional comfort and fit
- Thumb hole for additional protection all the way to the knuckle, without sacrificing dexterity

APPLICATIONS: *Automotive, Plastic Molding, Glass Handling and Metal Stamping*



ANSI
A4

**KUT GARD®
WITH DYNEEMA®
20-DA18**

- Excellent cut resistance
- Excellent abrasion protection
- 2-ply for additional wear protection
- Breathable
- Made from component materials that comply with federal regulations for food contact 21CFR 170-199

APPLICATIONS: *Electronics Manufacturing, Glass Cutting, Paper Processing, Food Processing*



ANSI
A2

**KUT GARD®
WITH DYNEEMA®
20-D18**

- Good cut protection
- High abrasion protection
- Elastic top provides a snug fit to prevent debris from entering the sleeve
- Made from component materials that comply with federal regulations for food contact 21CFR 170-199

APPLICATIONS: *Electronics Manufacturing, Glass Cutting, Paper Processing, Food Processing*

KUT GARD® WITH DYNEEMA®

| STYLE NUMBER | ASTM | MATERIAL | CONSTRUCTION | PLY | COLOR | STANDARD LENGTH |
|---------------------|------|-----------------------|-----------------------------------|-----|---------|-----------------|
| 20-DA4210 | A6 | ACP™ / Dyneema® Blend | Seamless Knit | 1 | ■ Gray | 21" |
| 20-DAPB22TOV | A4 | ACP™ / Dyneema® Blend | Seamless Knit | 1 | ■ Gray | 22" |
| 20-DA18 | A4 | ACP™ / Dyneema® Blend | Seamless Knit | 2 | ■ Gray | 18" |
| 20-DA18CL | A4 | ACP™ / Dyneema® Blend | Seamless Knit, 1-Ply Cotton Liner | 2 | ■ Gray | 18" |
| 20-DA18S | A3 | ACP™ / Dyneema® Blend | Seamless Knit | 1 | ■ Gray | 18" |
| 20-D18 | A2 | Dyneema® Diamond | Seamless Knit | 1 | ■ White | 18" |
| 20-TG18 | A2 | Spun Dyneema® | Seamless Knit | 2 | ■ Gray | 18" |
| 20-SD18 | A2 | Spun Dyneema® | Seamless Knit | 1 | ■ White | 18" |
| 20-TG18S | A2 | Spun Dyneema® | Seamless Knit | 1 | ■ Gray | 18" |

Replace standard 18" length with any custom length from 10" - 24"

FORM-FIT SEAMLESS KNIT SLEEVES

SECURE CLOSE-TO-SKIN COMFORT

LIGHT ABRASION COMFORT SLEEVE



Pritex™ is proprietary textured filament polyester, plus Antimicrobial fiber that provides exceptional comfort, will not cause skin irritation, and offers excellent abrasion protection and ANSI Cut Level 2 cut resistance.

KUT GARD® PRITEX™

| STYLE NUMBER | ASTM | MATERIAL | CONSTRUCTION | PLY | COLOR | WIDTH | STANDARD LENGTH |
|------------------------|------|-------------------------|-----------------------------|-----|----------------|-------|-----------------|
| 15-21PRI18KVBL* | A4 | Pritex™ / Kevlar® Blend | 2x1 Knit | 1 | Yellow / Black | --- | 18" |
| 15-21PRI18BL | A2 | Pritex™ | 2x1 Knit | 1 | Black | --- | 18" |
| 15-21PRI18WL | A2 | Pritex™ | 2x1 Knit | 1 | White | --- | 18" |
| 15-218BKL | A2 | Pritex™ | Textured Filament Polyester | 1 | Black | 6.5" | 18" |
| 15-218BKS | A2 | Pritex™ | Textured Filament Polyester | 1 | Black | 5" | 18" |
| 15-218WL | A2 | Pritex™ | Textured Filament Polyester | 1 | White | 6.5" | 18" |
| 15-218WS | A2 | Pritex™ | Textured Filament Polyester | 1 | White | 5" | 18" |
| 15-218NYL | A2 | Pritex™ | Textured Filament Polyester | 1 | Neon Yellow | 6.5" | 18" |
| 15-218NYS | A2 | Pritex™ | Textured Filament Polyester | 1 | Neon Yellow | 5" | 18" |
| 15-218NOL | A2 | Pritex™ | Textured Filament Polyester | 1 | Neon Orange | 6.5" | 18" |
| 15-218NOS | A2 | Pritex™ | Textured Filament Polyester | 1 | Neon Orange | 5" | 18" |
| 15-218NPL | A2 | Pritex™ | Textured Filament Polyester | 1 | Neon Pink | 6.5" | 18" |
| 15-218NPS | A2 | Pritex™ | Textured Filament Polyester | 1 | Neon Pink | 5" | 18" |

COTTON SLEEVES

| | | | | | | | |
|-----------------|-----|--------|--|---|-------|-----|-----|
| 31-C-18 | --- | Cotton | Seamless Knit, Unsewn Ends | 1 | White | --- | 18" |
| 31-CS18 | --- | Cotton | Seamless Knit, Overstitched at Both Ends | 1 | White | --- | 18" |
| 31-CDS18 | --- | Cotton | Seamless Knit | 2 | White | --- | 18" |

* Does not comply with federal regulations for food contact

Replace standard 18" length with any custom length from 10" - 24"



ANSI
A4

KUT GARD® PRITEX™ 15-21PRI18KVBL

- Excellent abrasion and fatigue resistance
- Silicone and latex free
- Manufactured with proprietary ACP™ Technology, featuring DuPont™ Kevlar® and fully encapsulated glass plus polyester
- Exceptional comfort and fit, will fit comfortably over clothing or directly on the arm

APPLICATIONS: *Sheet Metal Fabrication, Painting, Canning, Recycling, Assembly, Plastic Molding*



ANSI
A2

KUT GARD® PRITEX™ 15-218BKL

- Special blend of textured filament polyester plus Antimicrobial provides exceptional comfort and will not cause skin irritation
- Excellent abrasion and fatigue resistance
- 100% silicone and latex free
- Superior washability—can be washed repeatedly in chlorine bleach and caustic detergents
- Features a patented NSF/ANSI Standard 51 Conformant Antimicrobial that is FDA/EPA approved for food contact

APPLICATIONS: *Sheet Metal Fabrication, Painting, Canning, Recycling, Assembly, Plastic Molding*



DUO-PRO™

HI-VIS T-SHIRT WITH SEWN-IN INTEGRATED PROTECTIVE SLEEVES

ANSI 107 HI-VIS
SHORT SLEEVE
T-SHIRT



PRITEX™
2x1 KNIT
PROTECTIVE
SLEEVE



SEWN-IN
SLEEVES

DUO-PRO™

HI-VIS T-SHIRT WITH INTEGRATED PROTECTIVE SLEEVES

APPLICATIONS

CONSTRUCTION
MUNICIPALITIES
SHIPYARDS
RECYCLING
HVAC



| STYLE NUMBER | SHORT SLEEVE T-SHIRT | | | 2x1 KNIT PROTECTIVE SLEEVE | | |
|----------------------------|----------------------|--------------------|--------|----------------------------|--------|-------|
| | ANSI 107 | COLOR | SIZE | ANSI 105 | LENGTH | COLOR |
| 313-CNTSELY*-PRI18W | Type R Class 2 | Hi-Vis Lime Yellow | S - 5X | A2 | 18" | White |

Put the desired size of the shirt in place of the asterisk () in the part number

Patent pending design

Integrated protective sleeves help protect against cuts, scrapes, and abrasions

Eliminates the need for a vest and keeps sleeves in place for maximum arm protection coverage

LOOSE FITTING SLEEVES

COOLER FOR LONG WEAR APPLICATIONS



PAIR WITH



KUT GARD®
MADE WITH KEVLAR®
10-KVS18YBH

- Optimal cut resistance and comfort
- Kevlar® engineered yarns maximize durability and abrasion resistance
- Protection in light heat applications

APPLICATIONS: *Glass Operations, Metal Stamping, Automotive, Appliance and Machinery Manufacturing*



G-TEK® KEV™
09-K1600

- Superior cut resistance
- Good grip on dry, wet or oily surfaces
- Protection in light heat applications

APPLICATIONS: *Glass Cutting, Metal Handling, Fastening, Construction*



PAIR WITH



KUT GARD®
MADE WITH KEVLAR®
10-KVS18RD

- Red color for easy compliance detection on job site
- Kevlar® engineered yarns maximize durability and abrasion resistance
- Protection in light heat applications

APPLICATIONS: *Glass Operations, Metal Stamping, Automotive, Appliance and Machinery Manufacturing*



G-TEK® KEV™
09-K1640

- Red liner for easy compliance detection on job site
- Good grip on dry, wet or oily surfaces
- Protection in light heat applications

APPLICATIONS: *Glass Cutting, Metal Handling, Small Sharp Objects, Fastening*

CUT & HEAT PROTECTION WITH MATCHING GLOVES

LOOSE FITTING SLEEVES

COOLER FOR LONG WEAR APPLICATIONS



ANSI
A6

**KUT GARD®
MADE WITH KEVLAR®
10-KVS18DGH**

- High cut protection and comfort
- Kevlar® engineered yarns maximize durability and abrasion resistance
- Protection in light heat applications

APPLICATIONS: *Glass Operations, Metal Stamping, Automotive, Appliance and Machinery Manufacturing*

ANSI **A4** EN **5**
NITRILE FOAM COATING

**G-TEK® KEV™
09-K1630**

- Excellent durability and abrasion resistance
- Good grip on dry, wet or oily surfaces
- Protection in light heat applications

APPLICATIONS: *Metal Handling, Fastening, Construction, General Maintenance*



ANSI
A2

**KUT GARD®
MADE WITH KEVLAR®
10-4IK157**

- Good cut protection
- Light heat protection
- Elastic top provides a snug fit to prevent debris from entering the sleeve
- Thumb hole for additional protection all the way to the knuckle, without sacrificing dexterity

APPLICATIONS: *Metal Stamping, Sheet Metal, Automotive, Construction*

ANSI
A1

**KUT GARD®
MADE WITH KEVLAR®
10-K4722**

- Cut protection
- Light heat protection
- Elastic top provides a snug fit to prevent debris from entering the sleeve
- Thumb hole for additional protection all the way to the knuckle, without sacrificing dexterity

APPLICATIONS: *Metal Stamping, Sheet Metal, Automotive, Construction*



Kevlar.

DARE **BIGGER™**

Sleeves with DuPont™ Kevlar® provide excellent cut protection and protection from light heat for the wrists and arms. Available in single-ply or double-ply for added protection. Cotton inner ply styles offers added comfort. MTO options available for all sleeves in any length.



KUT GARD® MADE WITH KEVLAR®

| STYLE NUMBER | ASTM | MATERIAL | CONSTRUCTION | PLY | BOTTOM CUFF | TOP CUFF | COLOR | STANDARD LENGTH |
|--------------------|------|-----------------|------------------|-----|----------------------------|---------------------|------------------|-----------------|
| 10-KVS18RD | A6 | DuPont™ Kevlar® | Blousy | 1 | Elastic | Elastic | ■ Red | 12" & 18" |
| 10-KVS18DGH | A6 | DuPont™ Kevlar® | Blousy | 1 | Elastic | Elastic | ■ Dark Gray | 12" & 18" |
| 10-KVS18YBH | A6 | DuPont™ Kevlar® | Blousy | 1 | Elastic | Elastic | ■ Yellow / Black | 12" & 18" |
| 10-KSB18 | A3 | DuPont™ Kevlar® | Blousy | 1 | Elastic | Elastic | ■ Yellow | 18" |
| 10-K4826 | A2 | DuPont™ Kevlar® | Blousy Interlock | 1 | Knit Wrist with Thumb Hole | Blue / Gold Elastic | ■ Yellow | 26" |
| 10-4IK157 | A2 | DuPont™ Kevlar® | Blousy Interlock | 1 | Knit Wrist with Thumb Hole | Blue / Gold Elastic | ■ Yellow | 22" |
| 10-K4726 | A1 | DuPont™ Kevlar® | Blousy Interlock | 1 | Knit Wrist with Thumb Hole | Blue / Gold Elastic | ■ Yellow | 26" |
| 10-K4722 | A1 | DuPont™ Kevlar® | Blousy Interlock | 1 | Knit Wrist with Thumb Hole | Blue / Gold Elastic | ■ Yellow | 22" |

Replace standard 18" length with any custom length from 10" - 24"

SPECIALTY APPLICATIONS SLEEVES

KUT GARD®



DUCK & DENIM LIGHT ABRASION RISK

DUCK & DENIM

| STYLE NUMBER | ASTM | MATERIAL | CONSTRUCTION | PLY | COLOR | STANDARD LENGTH |
|-----------------|------|----------|-----------------------------------|-----|---------|-----------------|
| 31-48182 | --- | Duck | Elastic Overstitched at Both Ends | 1 | ■ White | 18" |
| 23-44182 | --- | Denim | Elastic Overstitched at Both Ends | 1 | ■ Blue | 18" |

Replace standard 18" length with any custom length from 10" - 24"



EXTRA MECHANICAL PROTECTION

Cane mesh provides protection from cuts and lacerations caused by glass, sheet or scrap metal, and other sharp objects

KUT GARD® CANE MESH

| STYLE NUMBER | ASTM | MATERIAL | CONSTRUCTION | PLY | COLOR | LENGTH | SIZE |
|-----------------|------|-----------------|--------------|-----|---------|--------|---------|
| 30-6775W | A4 | Nylon Cane Mesh | Cut-and-Sewn | 2 | ■ White | 7" | S - 4XL |
| 30-6775B | A4 | Nylon Cane Mesh | Cut-and-Sewn | 2 | ■ Black | 7" | S - 4XL |
| 30-6795W | A4 | Nylon Cane Mesh | Cut-and-Sewn | 2 | ■ White | 9" | S - 4XL |
| 30-6795B | A4 | Nylon Cane Mesh | Cut-and-Sewn | 2 | ■ Black | 9" | S - 4XL |



HIGH CUT PROTECTION FOR FOOD PROCESSING

KUT GARD® FOOD PROCESSING

| STYLE NUMBER | ASTM | MATERIAL | CONSTRUCTION | PLY | COLOR | STANDARD LENGTH |
|-------------------|------|----------------|---------------|-----|----------------|-----------------|
| 25-612 | A9 | PolyKor® Blend | Seamless Knit | 1 | ■ White | 12" |
| 25-618 | A9 | PolyKor® Blend | Seamless Knit | 1 | ■ White | 18" |
| 25-621 | A9 | PolyKor® Blend | Seamless Knit | 1 | ■ White | 21" |
| 25-7612BB | A7 | Dyneema® Blend | Seamless Knit | 1 | ■ Bright Blue | 12" |
| 25-7612BG | A7 | Dyneema® Blend | Seamless Knit | 1 | ■ Bright Green | 12" |
| 25-7612GRN | A7 | Dyneema® Blend | Seamless Knit | 1 | ■ Dark Green | 12" |
| 25-7612NP | A7 | Dyneema® Blend | Seamless Knit | 1 | ■ Neon Pink | 12" |

Replace standard 18" length with any custom length from 10" - 24"

AR/FR PROTECTION



KUT GARD® 10-KAM18

- Offers AR/FR and cut protection
- Excellent heat and flame resistance
- Thumb hole for additional protection all the way to the knuckle without sacrificing dexterity

APPLICATIONS: Sheet Metal, Glass Handling, High Heat Areas, Electrical Repair and Maintenance, Automotive Manufacturing, Plastic Molding

KUT GARD® ARC RATED ACP™ TECHNOLOGY & DUPONT™ KEVLAR®

| STYLE NUMBER | PPE LEVEL | CAL RATING | ASTM | MATERIAL | CONSTRUCTION | PLY | COLOR | STANDARD LENGTH |
|-----------------|-----------|------------|------|----------------------|------------------|-----|--------|-----------------|
| 10-KAM18 | 2 | 9.5 | A5 | ACP™ / Kevlar® Blend | Blousy Interlock | 2 | Yellow | 18" |

Replace standard 18" length with any custom length from 10" - 24"



SPECIALTY APPLICATIONS SLEEVES

KUT GARD®



IDEAL FOR WELDING



KUT GARD® 10-K4622

- Good cut protection
- Excellent thermal and flame protection from high heat
- Elastic top provides a snug fit to prevent debris from entering the sleeve
- Thumb hole for additional protection all the way to the knuckle without sacrificing dexterity

APPLICATIONS: Welding, Automotive, Aerospace and Metal Fabrication



11-45183

- Excellent thermal and flame protection from high heat
- Elastic top provides a snug fit to prevent debris from entering the sleeve

APPLICATIONS: Welding, Aerospace, Metal Fabrication



IDEAL FOR WELDING

FLAME, HEAT & SPARK PROTECTION

HEAT PROTECTION

| STYLE NUMBER | ASTM | MATERIAL | CONSTRUCTION | PLY | COLOR | LENGTH |
|-----------------|------|--------------------------------------|--|-----|----------------|--------|
| 10-K4626 | A2 | 60% FR Viscose / 40% DuPont™ Kevlar® | DuPont™ Kevlar® Wrist with Thumb Hole & Blue/Gold Elastic at Top | 1 | Yellow / Brown | 26" |
| 10-K4622 | A2 | 60% FR Viscose / 40% DuPont™ Kevlar® | DuPont™ Kevlar® Wrist with Thumb Hole & Blue/Gold Elastic at Top | 1 | Yellow / Brown | 22" |
| 11-45182 | --- | FR Green Sateen | Elastic Overstitched at Both Ends | 1 | Green | 18" |
| 11-45183 | --- | FR Green Sateen | Blue/Gold Elastic at Both Ends | 1 | Green | 18" |
| 11-45153 | --- | FR Green Sateen | DuPont™ Kevlar® Wrist with Thumb Hole & Blue/Gold Elastic at Top | 1 | Green | 15" |

Replace standard 18" length with any custom length from 10" - 24"

CUSTOM OPTIONS FOR

When it comes to arm protection, you don't have to settle for what's already out there.

Identify your safety need, then customize your solution by choosing the **Material, Size, and Option(s)** to maximize performance.

**Call PIP at
1-800-262-5755**

For part numbers and pricing for your order, or if a custom option you need is not listed here.



Orders will ship within 2 weeks
(up to 4 weeks for Pritex™ sleeves).

APPLICATION & MATERIAL

| | | MATERIAL | PLY | STRUCTURE |
|---------------------------|--|--------------------------------|--------------|--------------|
| CUT PROTECTION | ANSI A9 | PolyKor® Blend | 1 | Tube Knit |
| | | Dyneema® Blend | 1 | Tube Knit |
| | ANSI A6 | ACP™ / Dyneema® Blend | 1 | Tube Knit |
| | | DuPont™ Kevlar® | 1 | Tube Knit |
| | ANSI A5 | ACP™ / Kevlar® Blend | 1 & 2 | Tube Knit |
| | | ACP™ / Kevlar® Blend | 1 | Tube Knit |
| | ANSI A4 | ACP™ / Kevlar® / Pritex™ Blend | 1 | Tube Knit |
| | | ACP™ / Dyneema® Blend | 1 & 2 | Tube Knit |
| | | Pritex™ / Kevlar® Blend | 1 | Tube Knit |
| | ANSI A3 | ACP™ / Kevlar® Blend | 1 | Tube Knit |
| ACP™ / Dyneema® Blend | | 1 | Tube Knit | |
| DuPont™ Kevlar® | | 1 & 2 | Tube Knit | |
| Pritex™ | | 1 | Tube Knit | |
| ANSI A2 | DuPont™ Kevlar® | 1 | Tube Knit | |
| | Dyneema® Diamond Technology | 1 | Tube Knit | |
| | Spun Dyneema® | 1 & 2 | Tube Knit | |
| | FR Viscose / DuPont™ Kevlar® | 1 | Cut-and-Sewn | |
| HEAT PROTECTION* | High Heat & Thermal | FR Viscose / DuPont™ Kevlar® | 1 | Cut-and-Sewn |
| | | FR Green Sateen | 1 | Cut-and-Sewn |
| FOOD HANDLING | Meets FDA 21CFR 170-199 Food Handling Requirements | DuPont™ Kevlar® | 1 | Tube Knit |
| | | ACP™ / Dyneema® Blend | 2 | Tube Knit |
| | | Dyneema® Diamond Technology | 1 | Tube Knit |
| | | Pritex™ | 1 | Tube Knit |
| | | PolyKor® Blend | 1 | Tube Knit |
| GENERAL PROTECTION | Light Abrasion Risk | Dyneema® Blend | 1 | Tube Knit |
| | | Cotton | 1 & 2 | Tube Knit |
| | | Duck | 1 | Cut-and-Sewn |
| | | Denim | 1 | Cut-and-Sewn |

SIZES

| LENGTHS | STANDARD WIDTH |
|-----------|----------------|
| 10" - 24" | 3", 3.5" or 4" |
| 10" - 24" | 3", 3.5" or 4" |
| 10" - 24" | 3", 3.5" or 4" |
| 10" - 24" | 3", 3.5" or 4" |
| 10" - 24" | 3", 3.5" or 4" |
| 10" - 24" | 3", 3.5" or 4" |
| 10" - 24" | 3", 3.5" or 4" |
| 10" - 24" | 3", 3.5" or 4" |
| 10" - 24" | 3", 3.5" or 4" |
| 10" - 24" | 3", 3.5" or 4" |
| 10" - 24" | 3", 3.5" or 4" |

*Not NFPA 2112 certified and not ARC-rated

Custom sizes available upon request

ENHANCED PERFORMANCE

ADDITIONAL OPTIONS

FINGER & THUMB OPTIONS



▲ Thumb Hole



▲ Thumb Slot (bar tack)



▲ Elastic Thumb

BEST SELLING OPTIONS



▲ Half Thumb



▲ Additional Bar Tacks for Fingers

TOP OF THE ARM OPTIONS



▲ Non-Slip Top

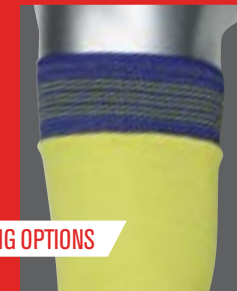

▲ 2" Blue/Gold Elastic



▲ 3/4" White Elastic

BEST SELLING OPTIONS



▲ Hook & Loop Closure



▲ Nylon Strap with Ring & Clip
(for shirt)



▲ Double Clip & Ring
110-SLEEVECLIP

BRINGING THE BEST OF THE WORLD TO YOU®

PERSONAL PROTECTIVE EQUIPMENT

UNDERSTANDING HEAD PROTECTION

PIP PROVIDES A COMPREHENSIVE OFFERING OF HEAD PROTECTION, INCLUDING HARD HATS, HELMETS, AND BUMP CAPS. WHEN SELECTING A HARD HAT, THE FIRST CONSIDERATION IS WHETHER YOU NEED ANSI TYPE I OR TYPE II PROTECTION, BASED ON OSHA REQUIREMENTS FOR YOUR GIVEN JOB AND/OR ENVIRONMENT. TYPE II MEETS REQUIREMENTS FOR ADDED SIDE IMPACT AND PENETRATION PROTECTION.

HARD HAT STYLES

Hard hats come in cap style and full brim, and both are available in vented and non-vented options.

- **Cap Style** hard hats shade your face and eyes.
- **Full Brim** hard hats shade your face, eyes, ears, and neck.
- **Non-Vented** Evolution® hard hats in this section meet **Class E** (Electrical) protection.
- **Vented** Evolution® hard hats in this section meet **Class C** (Conductive) protection. The vented option provides a cooler, more comfortable experience, though they are not intended for use near electrical hazards.

The size of the hard hat can be adjusted either by wheel ratchet or slip ratchet, depending on the option selected.

- The **wheel ratchet** provides a quicker and easier adjustment.
- The **slip ratchet** is a more economical solution that is still simple to adjust.



Class E (Electrical) protection means the hard hat is proof-tested at **20,000 volts**.



Class G (General) protection means the hard hat is proof-tested at **2,200 volts**.



Class C (Conductive) protection means the hard hat is not intended for use near electrical hazards, but is vented for breathability.

SPECIALTY HEAD PROTECTION

Specialty **helmets** are available for several industries, including fire, rescue, wildland, and high altitude workers, among others. These specialty helmets meet the stricter requirements for those specific work environments.

When head protection is not required but the risk of head injury persists, **bump caps** should be considered. While they are not ANSI rated, bump caps can help protect against incidental bumps and scrapes, especially if you're working in areas with a low vertical clearance. The low-profile baseball cap style increases user acceptability, giving workers a comfortable option that they will want to wear. Ranger style is ideal for outdoor workers, providing additional shade from the sun's UV rays.

[150 TYPE II HARD HATS](#)

[151 TYPE I HARD HATS](#)

[157 HARD HAT ACCESSORIES](#)

[160 BUMP CAPS](#)

[162 GEAR BAGS & RESCUE HELMETS](#)

[163 FIRE HELMETS](#)

[164 WINTER LINERS](#)

[166 FLAME & FIRE RESISTANT HOODS](#)

HEAD PROTECTION

TYPE II HARD HATS

MK8 EVOLUTION®

MK8 EVOLUTION® SERIES - TYPE II HARD HATS

CAP STYLE



MK8 EVOLUTION® CAP STYLE

| | | | |
|-----------------------|---|------|------------|
| KEY FEATURE | Type II Offering Side Impact & Penetration Protection | | |
| APPLICATIONS | Construction / Oil & Gas / Demolition | | |
| SUSPENSION | Polyester Textile Straps with Crown Pad Webbing | | |
| IMPACT LINER | Expanded Polystyrene (EPS) | | |
| SIZE ADJUSTMENT | Wheel Ratchet | | |
| SHELL MATERIAL | High-Density Polyethylene (HDPE) | | |
| SWEATBAND | Microfiber | | |
| STANDARDS MET | ANSI Z89.1 | | |
| IMPACT TYPE | Type II | | |
| ELECTRICAL CLASS | Class E (Non-Vented) Class C (Vented) | | |
| STYLE NUMBER | COLOR | BRIM | SHELL |
| 280-AHS150-10 | ■ White | Cap | Non-Vented |
| 280-AHS150-20 | ■ Yellow | Cap | Non-Vented |
| 280-AHS150-50 | ■ Blue | Cap | Non-Vented |
| 280-AHS150V-10 | ■ White | Cap | Vented |

MK8 EVOLUTION® LINESMAN

| | | | |
|-----------------------|---|------|------------|
| KEY FEATURE | Includes a Mounted 4-Point Chin Strap Harness | | |
| APPLICATIONS | Linesman / Construction / Offshore Marine | | |
| SUSPENSION | Polyester Textile Straps with Crown Pad Webbing | | |
| IMPACT LINER | Expanded Polystyrene (EPS) | | |
| SIZE ADJUSTMENT | Wheel Ratchet | | |
| SHELL MATERIAL | High-Density Polyethylene (HDPE) | | |
| SWEATBAND | Microfiber | | |
| STANDARDS MET | ANSI Z89.1 | | |
| IMPACT TYPE | Type II | | |
| ELECTRICAL CLASS | Class E (Non-Vented) Class C (Vented) | | |
| STYLE NUMBER | COLOR | BRIM | SHELL |
| 280-AHS240-10 | ■ White | Cap | Non-Vented |
| 280-AHS240-20 | ■ Yellow | Cap | Non-Vented |
| 280-AHS240-50 | ■ Blue | Cap | Non-Vented |
| 280-AHS240V-10 | ■ White | Cap | Vented |



IMPACT PROTECTION

Side, front and rear impact protection from the shock absorbing Expanded Polystyrene (EPS) impact liner meets **ANSI Type II standards**. Offers 20 times the coverage area of a Type I hard hat.

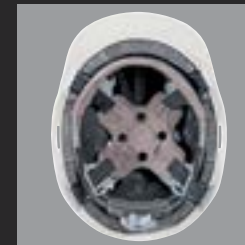

SUPREME COMFORT

Deluxe polyester textile strap suspension with a microfiber crown pad. Lightweight EPS liner reduces total weight to 19 ounces, while still offering maximum protection.



TOUGH OUTER SHELL

High strength outer shell with ribbed channels running across the top to dissipate impact energy. All around protection down 60° from vertical. Large imprint area on front "shield."



FIRM FIT ADJUSTMENT

Intuitive thumb and forefinger press points for easy adjustment of the wheel ratchet. The Linesman has an ANSI approved chin strap for retention on a Type II hard hat.

The three-rib design is a registered trademark of E.D. Bullard Company and used under license.

EVOLUTION® 6100 SERIES - TYPE I HARD HATS



CAP STYLE

TRADITIONAL STYLING WITH ENHANCED STRENGTH AND PROTECTION

FIVE RAISED CHANNELS

Modernizes the aesthetic look, but also strengthens the hard hat

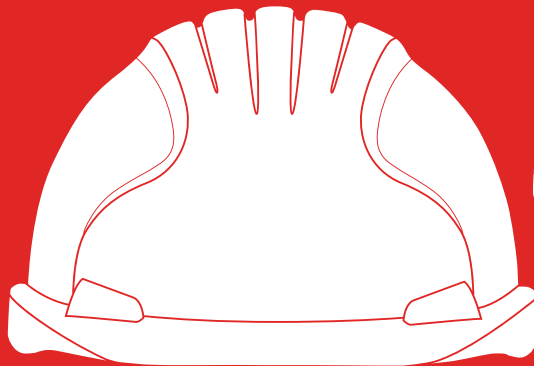

FRONT BRIM OPTIONS

Available in a short 1/2" brim style in addition to regular 1" cap style brim

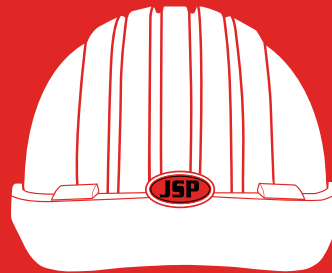

10% MORE

EXTRA PROTECTION ZONE

Provides 10% more coverage at the back/sides of the head and neck for extra deflection protection



FULL BRIM

FOR ADDITIONAL PROTECTION AGAINST SUN, GLARE, RAIN AND FALLING DEBRIS

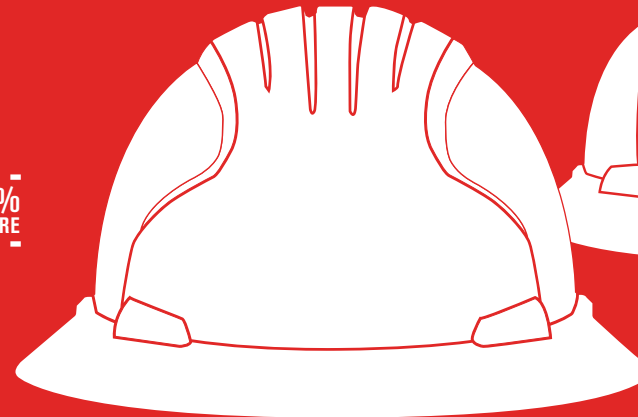

SHORTER FRONT BRIM

Shades the face while allowing excellent visibility



LONGER BACK BRIM

Helps protect neck and ears from the sun's UV rays, and functions as a run-off for rain and snow

TEXTURED UNDERSIDE

Helps reduce reflection and glare off the brim

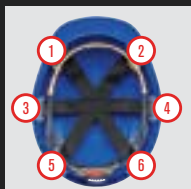

PRE-ASSEMBLED

All JSP® hard hats are packed ready-to-wear with no assembly of the 6-point suspension required.

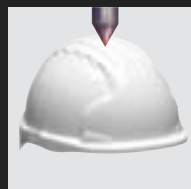

TOUGH HDPE SHELL

Modern design is enhanced with five raised channels that run across the top of the head down to the extended back area.



3D PRECISION FITTING

Never before has such a precise fit been attainable on an industrial safety hard hat, using the unique 3-position harness depth setting.



VENTILATION OPTION

Allows air movement inside the shell. This can reduce the inside hat temperature by an average of 4-6°F. Ideal when using cooling products.

TYPE I HARD HATS

EVOLUTION® 6100 SERIES – WHEEL RATCHET

EVOLUTION® DELUXE 6161 FULL BRIM

| | | | |
|--------------------------------|--|---------------------|------------|
| KEY FEATURE | Wheel Ratchet Creates a Firm Comfortable Fit | | |
| APPLICATIONS | Construction / Industrial | | |
| SUSPENSION | 6-Point Polyester Textile | | |
| SIZE ADJUSTMENT | Wheel Ratchet | | |
| SHELL MATERIAL | High-Density Polyethylene (HDPE) | | |
| SWEATBAND | Chamlon™ | | |
| EVOSPEC™ COMPATIBLE | Yes | CR2 KIT COMPATIBLE | Yes |
| STANDARDS MET | ANSI Z89.1 | | |
| IMPACT TYPE | Type I | | |
| ELECTRICAL CLASS | Class E (Non-Vented), Class C (Vented) | | |
| STYLE NUMBER | COLOR | BRIM | SHELL |
| 280-EV6161-10 | ■ White | Full | Non-Vented |
| 280-EV6161-20 | ■ Yellow | Full | Non-Vented |
| 280-EV6161-30 | ■ Green | Full | Non-Vented |
| 280-EV6161-40 | ■ Gray | Full <td Non-Vented | |
| 280-EV6161-50 | ■ Blue | Full | Non-Vented |
| 280-EV6161-60 | ■ Red | Full | Non-Vented |
| 280-EV6161-OR | ■ Bright Orange | Full | Non-Vented |
| 280-EV6161-LY | ■ Lime Yellow | Full | Non-Vented |
| 280-EV6161V-10 | ■ White | Full | Vented |
| 280-EV6161V-20 | ■ Yellow | Full | Vented |
| 280-EV6161V-30 | ■ Green | Full | Vented |
| 280-EV6161V-40 | ■ Gray | Full | Vented |
| 280-EV6161V-50 | ■ Blue | Full | Vented |
| 280-EV6161V-60 | ■ Red | Full | Vented |
| 280-EV6161V-OR | ■ Bright Orange | Full | Vented |
| 280-EV6161V-LY | ■ Lime Yellow | Full | Vented |



EVOLUTION® 6100 SERIES

REVOLUTION® WHEEL RATCHET



US &
IMPORTED
MATERIALS

TYPE I HARD HATS

EVOLUTION® 6100 SERIES & COMFORT PLUS™ – WHEEL RATCHET



- Easy-to-use wheel ratchet adjustment system creates a firm, comfortable fit with added security
- The deep nape strap design enables firm retention, keeping the hard hat in place on the head even when fully inverted
- Closed ratchet design won't snag longer hair

EVOLUTION® DELUXE 6151 CAP STYLE

| KEY FEATURE | Wheel Ratchet Creates a Firm Comfortable Fit | | |
|---------------------------------|--|--------------------|------------|
| APPLICATIONS | Construction / Industrial | | |
| SUSPENSION | 6-Point Polyester Textile | | |
| SIZE ADJUSTMENT | Wheel Ratchet | | |
| SHELL MATERIAL | High-Density Polyethylene (HDPE) | | |
| SWEATBAND | Chamlon™ | | |
| EVOSPEC™ COMPATIBLE | Yes | CR2 KIT COMPATIBLE | Yes |
| STANDARDS MET | ANSI Z89.1 | | |
| IMPACT TYPE | Type I | | |
| ELECTRICAL CLASS | Class E (Non-Vented), Class C (Vented) | | |
| STYLE NUMBER | COLOR | BRIM | SHELL |
| 280-EV6151-10 | ■ White | Standard | Non-Vented |
| 280-EV6151-11 | □ Black | Standard | Non-Vented |
| 280-EV6151-20 | ■ Yellow | Standard | Non-Vented |
| 280-EV6151-30 | ■ Green | Standard | Non-Vented |
| 280-EV6151-39 | ■ Pink | Standard | Non-Vented |
| 280-EV6151-40 | ■ Gray | Standard | Non-Vented |
| 280-EV6151-50 | ■ Blue | Standard | Non-Vented |
| 280-EV6151-60 | ■ Red | Standard | Non-Vented |
| 280-EV6151-OR | ■ Bright Orange | Standard | Non-Vented |
| 280-EV6151-LY | ■ Lime Yellow | Standard | Non-Vented |
| 280-EV6151S-10 | ■ White | Short | Non-Vented |
| 280-EV6151S-20 | ■ Yellow | Short | Non-Vented |
| 280-EV6151V-10 | ■ White | Standard | Vented |
| 280-EV6151V-20 | ■ Yellow | Standard | Vented |
| 280-EV6151V-40 | ■ Gray | Standard | Vented |
| 280-EV6151V-50 | ■ Blue | Standard | Vented |
| 280-EV6151V-LY | ■ Lime Yellow | Standard | Vented |
| 280-EV6151V-OR | ■ Bright Orange | Standard | Vented |
| 280-EV6151SV-10 | ■ White | Short | Vented |
| 280-EV6151SV-20 | ■ Yellow | Short | Vented |
| 280-EV6151SV-50 | ■ Blue | Short | Vented |



US & IMPORTED MATERIALS

COMFORT PLUS™ 5151 CAP STYLE

| KEY FEATURE | Economical Version with Pivoting Wheel Ratchet | | |
|-------------------------------|--|-----------|------------|
| APPLICATIONS | Construction / Industrial | | |
| SUSPENSION | 6-Point Polyester Textile | | |
| SIZE ADJUSTMENT | Wheel Ratchet | | |
| SHELL MATERIAL | High-Density Polyethylene (HDPE) | | |
| SWEATBAND | Nylon Backed Foam | | |
| STANDARDS MET | ANSI Z89.1 | | |
| IMPACT TYPE | Type I | | |
| ELECTRICAL CLASS | Class G | | |
| STYLE NUMBER | COLOR | BRIM | SHELL |
| 280-ML5151-10 | ■ White | Cap Style | Non-Vented |
| 280-ML5151-20 | ■ Yellow | Cap Style | Non-Vented |
| 280-ML5151-30 | ■ Green | Cap Style | Non-Vented |
| 280-ML5151-39 | ■ Pink | Cap Style | Non-Vented |
| 280-ML5151-50 | ■ Blue | Cap Style | Non-Vented |
| 280-ML5151-60 | ■ Red | Cap Style | Non-Vented |
| 280-ML5151-80 | ■ Orange | Cap Style | Non-Vented |

COMFORT PLUS™

VALUE

WHEEL RATCHET



TYPE I HARD HATS

EVOLUTION® 6100 SERIES – SLIP RATCHET

EVOLUTION® 6100 SERIES

EASYJUST® SLIP RATCHET



EVOLUTION® 6121 CAP STYLE

| | | | |
|---------------------|--|--------------------|-----|
| KEY FEATURE | Economical Polyethylene Suspension with Slip Ratchet | | |
| APPLICATIONS | Construction / Industrial | | |
| SUSPENSION | 6-Point Polyethylene | | |
| SIZE ADJUSTMENT | Slip Ratchet | | |
| SHELL MATERIAL | High-Density Polyethylene (HDPE) | | |
| SWEATBAND | Nylon Backed Foam | | |
| EVOSPEC™ COMPATIBLE | No | CR2 KIT COMPATIBLE | Yes |
| STANDARDS MET | ANSI Z89.1 | | |
| IMPACT TYPE | Type I | | |
| ELECTRICAL CLASS | Class E | | |

| STYLE NUMBER | COLOR | BRIM | SHELL |
|-----------------------------|--|----------|------------|
| <u>280-EV6121-10</u> | <input type="checkbox"/> White | Standard | Non-Vented |
| <u>280-EV6121-20</u> | <input type="checkbox"/> Yellow | Standard | Non-Vented |
| <u>280-EV6121-30</u> | <input type="checkbox"/> Green | Standard | Non-Vented |
| <u>280-EV6121-39</u> | <input type="checkbox"/> Pink | Standard | Non-Vented |
| <u>280-EV6121-40</u> | <input type="checkbox"/> Gray | Standard | Non-Vented |
| <u>280-EV6121-50</u> | <input type="checkbox"/> Blue | Standard | Non-Vented |
| <u>280-EV6121-60</u> | <input type="checkbox"/> Red | Standard | Non-Vented |
| <u>280-EV6121-OR</u> | <input type="checkbox"/> Bright Orange | Standard | Non-Vented |
| <u>280-EV6121-LY</u> | <input type="checkbox"/> Lime Yellow | Standard | Non-Vented |

EVOLUTION® DELUXE 6131 CAP STYLE

| | | | |
|---------------------|--|--------------------|-----|
| KEY FEATURE | Polyester Textile Suspension with Slip Ratchet | | |
| APPLICATIONS | Construction / Industrial | | |
| SUSPENSION | 6-Point Polyester Textile | | |
| SIZE ADJUSTMENT | Slip Ratchet | | |
| SHELL MATERIAL | High-Density Polyethylene (HDPE) | | |
| SWEATBAND | Chamlon™ | | |
| EVOSPEC™ COMPATIBLE | Yes | CR2 KIT COMPATIBLE | Yes |
| STANDARDS MET | ANSI Z89.1 | | |
| IMPACT TYPE | Type I | | |
| ELECTRICAL CLASS | Class E (Non-Vented), Class C (Vented) | | |

| STYLE NUMBER | COLOR | BRIM | SHELL |
|------------------------------|--|----------|------------|
| <u>280-EV6131-10</u> | <input type="checkbox"/> White | Standard | Non-Vented |
| <u>280-EV6131-20</u> | <input type="checkbox"/> Yellow | Standard | Non-Vented |
| <u>280-EV6131-30</u> | <input type="checkbox"/> Green | Standard | Non-Vented |
| <u>280-EV6131-50</u> | <input type="checkbox"/> Blue | Standard | Non-Vented |
| <u>280-EV6131-60</u> | <input type="checkbox"/> Red | Standard | Non-Vented |
| <u>280-EV6131-OR</u> | <input type="checkbox"/> Bright Orange | Standard | Non-Vented |
| <u>280-EV6131-LY</u> | <input type="checkbox"/> Lime Yellow | Standard | Non-Vented |
| <u>280-EV6131V-10</u> | <input type="checkbox"/> White | Standard | Vented |
| <u>280-EV6131V-20</u> | <input type="checkbox"/> Yellow | Standard | Vented |

EVOLUTION® DELUXE 6141 FULL BRIM

| | | | |
|---------------------|--|--------------------|-----|
| KEY FEATURE | Polyester Textile Suspension with Slip Ratchet | | |
| APPLICATIONS | Construction / Industrial | | |
| SUSPENSION | 6-Point Polyester Textile | | |
| SIZE ADJUSTMENT | Slip Ratchet | | |
| SHELL MATERIAL | High-Density Polyethylene (HDPE) | | |
| SWEATBAND | Chamlon™ | | |
| EVOSPEC™ COMPATIBLE | Yes | CR2 KIT COMPATIBLE | Yes |
| STANDARDS MET | ANSI Z89.1 | | |
| IMPACT TYPE | Type I | | |
| ELECTRICAL CLASS | Class E (Non-Vented), Class C (Vented) | | |

| STYLE NUMBER | COLOR | BRIM | SHELL |
|------------------------------|--|------|------------|
| <u>280-EV6141-10</u> | <input type="checkbox"/> White | Full | Non-Vented |
| <u>280-EV6141-20</u> | <input type="checkbox"/> Yellow | Full | Non-Vented |
| <u>280-EV6141-30</u> | <input type="checkbox"/> Green | Full | Non-Vented |
| <u>280-EV6141-50</u> | <input type="checkbox"/> Blue | Full | Non-Vented |
| <u>280-EV6141-60</u> | <input type="checkbox"/> Red | Full | Non-Vented |
| <u>280-EV6141-OR</u> | <input type="checkbox"/> Bright Orange | Full | Non-Vented |
| <u>280-EV6141-LY</u> | <input type="checkbox"/> Lime Yellow | Full | Non-Vented |
| <u>280-EV6141V-10</u> | <input type="checkbox"/> White | Full | Vented |
| <u>280-EV6141V-20</u> | <input type="checkbox"/> Yellow | Full | Vented |



**280-EV6121 CAP STYLE & 280-EV6141 FULL BRIM
AVAILABLE AS A GO-TO WORK KIT**



GO-TO-WORK KIT

PACKED READY TO WEAR

CHOOSE FROM 2
HARD HAT MODELS >



EVOLUTION 6141 FULL BRIM
280-EV6141



EVOLUTION 6121 CAP STYLE
280-EV6121

GET THESE PRE-PACKED INSIDE!



ANSI CLASS 2 VALUE MESH VEST
Hi-Vis Lime Yellow
302-MVGLY



BOUTON® OPTICAL ZENON Z12
Gray Lens/Black Temple
250-01-0001



G-TEK® NYLON FOAM NITRILE GRIP
Gray Liner/Black Grip
34-C232



DISPOSABLE CORDED EAR PLUGS
NRR 32 dB - Hi-Vis Orange
265-100C

GRAB, GO & GET TO WORK!

| ITEM NUMBER | HARD HAT | GLOVES | VEST |
|-------------------------------------|-----------|--------|------|
| 289-GTW-6121-M/L | Cap Style | M | L |
| 289-GTW-6141-M/L | Full Brim | M | L |
| 289-GTW-6121-L/XL | Cap Style | L | XL |
| 289-GTW-6141-L/XL | Full Brim | L | XL |
| 289-GTW-6121-XL/XXL | Cap Style | XL | XXL |
| 289-GTW-6141-XL/XXL | Full Brim | XL | XXL |

CUSTOM KITS AVAILABLE

WANT TO CHANGE A COLOR OR SIZE?
OR DEVELOP YOUR OWN UNIQUE KIT?

ASK US FOR A QUOTE TODAY

TYPE I HARD HATS

GO-TO-WORK KIT



▲ [289-GTW-6121-M/M-39](#)

PINKit GO-TO-WORK KIT

PRE-PACKED ITEMS:

EVOLUTION 6121 CAP STYLE
[280-EV6121-39](#)

ANSI CLASS 2 VALUE MESH VEST
Hi-Vis Lime Yellow
[302-MVGLY/M](#)

EVA®
Clear Lens/Clear & Pink Temple
[250-10-0900](#)

MAXIFLEX® ACTIVE™ NYLON
FOAM NITRILE GRIP
Light Pink Liner/Pink Grip
[34-8264/M](#)

DISPOSABLE COMPACT
X-EMBOSS CORDED EAR PLUGS
Pink
[267-HPF300C](#)



TYPE I HARD HATS

MINING / HIGH ALTITUDE



EVOLUTION® 6100 MINING

| | | | |
|---------------------|---|--------------------|-----|
| KEY FEATURE | Includes Mining Lamp Bracket & Cable Loop | | |
| APPLICATIONS | Mining Industry | | |
| SUSPENSION | 6-Point Polyester Textile | | |
| SIZE ADJUSTMENT | Wheel Ratchet | | |
| SHELL MATERIAL | High-Density Polyethylene (HDPE) | | |
| SWEATBAND | Chamlon™ | | |
| EVOSPEC™ COMPATIBLE | Yes | CR2 KIT COMPATIBLE | Yes |

| | | | |
|------------------|------------|--|--|
| STANDARDS MET | ANSI Z89.1 | | |
| IMPACT TYPE | Type I | | |
| ELECTRICAL CLASS | Class C | | |

| STYLE NUMBER | COLOR | BRIM |
|--------------------------------|---------------|-----------|
| 280-EV6151M-10 | White | Cap Style |
| 280-EV6151M-20 | Yellow | Cap Style |
| 280-EV6151M-30 | Green | Cap Style |
| 280-EV6151M-50 | Blue | Cap Style |
| 280-EV6151M-60 | Red | Cap Style |
| 280-EV6151M-OR | Bright Orange | Cap Style |
| 280-EV6151M-LY | Lime Yellow | Cap Style |
| 280-EV6161M-10 | White | Full |
| 280-EV6161M-20 | Yellow | Full |
| 280-EV6161M-30 | Green | Full |
| 280-EV6161M-50 | Blue | Full |
| 280-EV6161M-60 | Red | Full |
| 280-EV6161M-OR | Bright Orange | Full |
| 280-EV6161M-LY | Lime Yellow | Full |

EVOLUTION® 6100 MINING WITH CR2 REFLECTIVE KIT

| STYLE NUMBER | COLOR | BRIM | CR2 DECALS |
|-----------------------------------|--------------|-----------|------------|
| 280-EV6151MCR2-XX | All 7 Colors | Cap Style | Silver |
| 280-EV6161MCR2-XX | All 7 Colors | Full | Silver |

EVOLUTION® 6100 MINING

COMPATIBLE WITH 99% OF MINING LAMPS

*Lamp torch not included

EVOLITE® SKYWORKER™

| | | | |
|-------------------------------|--|--------------------|--------|
| KEY FEATURE | The Best Features from the Evolution Series Combined with the Aspects Required for High Altitude Workers | | |
| APPLICATIONS | Industrial / Mountaineering / Rescue | | |
| SUSPENSION | 6-Point Polyester Textile | | |
| SIZE ADJUSTMENT | Wheel Ratchet | | |
| SHELL MATERIAL | Lightweight ABS Plastic | | |
| IMPACT LINER | Expanded Polystyrene (EPS) | | |
| CHIN STRAP | 4-Point Cross-Over with Quick Release Buckle | | |
| SWEATBAND | Chamlon™ with PU Coating | | |
| EVOSPEC™ COMPATIBLE | No | CR2 KIT COMPATIBLE | Yes |
| STANDARDS MET | ANSI Z89.1 & EN 12492 Mountaineering | | |
| IMPACT TYPE | Type I | | |
| ELECTRICAL CLASS | Class C (Vented) | | |
| STYLE NUMBER | COLOR | BRIM | SHELL |
| 280-AJS260-10 | White | Short | Vented |



LIGHTWEIGHT COMFORT & STRENGTH

DESIGNED FOR HIGH-ALTITUDE WORKERS



HARD HAT ACCESSORIES

REFLECTIVE DECALS



FULL REFLECTIVE COVERAGE

PROTECTION

DAY & NIGHT

CR2 REFLECTIVE DECAL KITS FOR JSP® EVOLUTION® HARD HATS

Easy for user to apply; sold in packs of 10 applications

- Class R2 reflective material offers significantly more brightness than standard reflective material
- High-intensity prismatic pattern features enhanced brightness day or night, and better visibility in all weather conditions
- Offers full 360° reflective coverage, plus strips on top
- Six reflective colors are available in both a cap-style and full-brim configuration
- Decal colors can be used to indicate function, while stocking only a basic white hard hat
- Ideal for hazardous environments where workers must be seen: construction, mining, highway, civil engineering or offshore

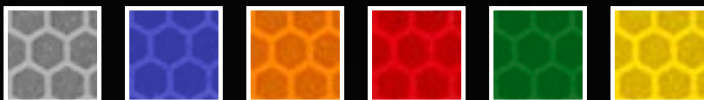

▲ 281-CR2-10



▲ 281-CR2FB-10

| STYLE NUMBER | FITS | COLOR |
|------------------------|---------------------------------|----------|
| 281-CR2-10 | Cap Style JSP® Evolution® | ■ Silver |
| 281-CR2-10-BL | Cap Style JSP® Evolution® | ■ Blue |
| 281-CR2-10-OR | Cap Style JSP® Evolution® | ■ Orange |
| 281-CR2-10-RE | Cap Style JSP® Evolution® | ■ Red |
| 281-CR2-10-GR | Cap Style JSP® Evolution® | ■ Green |
| 281-CR2-10-YE | Cap Style JSP® Evolution® | ■ Yellow |
| 281-CR2FB-10 | Full Brim Style JSP® Evolution® | ■ Silver |
| 281-CR2FB-10-BL | Full Brim Style JSP® Evolution® | ■ Blue |
| 281-CR2FB-10-OR | Full Brim Style JSP® Evolution® | ■ Orange |
| 281-CR2FB-10-RE | Full Brim Style JSP® Evolution® | ■ Red |
| 281-CR2FB-10-GR | Full Brim Style JSP® Evolution® | ■ Green |
| 281-CR2FB-10-YE | Full Brim Style JSP® Evolution® | ■ Yellow |
| 281-CR2SW-10 | Evollite® Skyworker™ | ■ Silver |

HARD HAT ACCESSORIES

EYEWEAR / CLIP SET

EVOSPEC™

RETRACTABLE SAFETY GLASSES

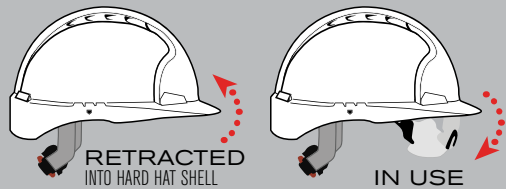

EVOSPEC™

- Easy assembly into any Evolution® Deluxe 6100 hard hat
- Retracts into helmet shell when not in use
- Anti-scratch/anti-fog lens coating
- Meets ANSI Z87.1 requirements

| STYLE NUMBER | TEMPLES | LENS |
|------------------------------|---------|------------------|
| 250-EVS-0000 | ■ Black | □ Clear |
| 250-EVS-0001 | ■ Black | ■ Gray |
| 250-EVS-0002 | ■ Black | ■ Indoor/Outdoor |



EXTEND THE LIFE & FUNCTIONS OF YOUR JSP® HARD HATS



HEAD LAMPS
2 SIDE CLIPS & 2 REAR CLIPS



GOGGLES
2 REAR CLIPS

LAMP / GOGGLE CLIP SET

- Allow the attachment of a head lamp or goggle to an Evolution® 6100 Cap Style hard hat
- The 2 rear clips are needed for attaching goggles to a helmet; all 4 clips are needed for attaching a head lamp to a helmet

| ITEM NUMBER | SIDE CLIPS | REAR CLIPS |
|----------------------------|------------|------------|
| 281-CL-SET | 2 | 2 |

HARD HAT ACCESSORIES

REPLACEMENT / ENHANCEMENT



▲ **281-SB-CHN**



▲ **281-SB-NBF**



▲ **281-SB-NBF/CP**

REPLACEMENT SWEATBANDS

| ITEM NUMBER | FITS | MATERIAL | COLOR |
|----------------------|-------------------|-------------------|---------|
| 281-SB-CHN | Evolution® Deluxe | Chamlon™ | ■ Tan |
| 281-SB-NBF | Evolution® 6121 | Nylon Backed Foam | ■ Black |
| 281-SB-NBF/CP | Comfort Plus™ | Nylon Backed Foam | ■ Black |



◀ **281-CS-4PT**



▲ **281-CS-2PT**



▲ **281-CSD-2PT**

OPTIONAL CHIN STRAPS

| ITEM NUMBER | STRAP | FITS | COLOR |
|--------------------|------------------|---------------------------|----------------------|
| 281-CS-2PT | 2-Point Standard | All JSP® Hard Hats | ■ Red / White / Blue |
| 281-CSD-2PT | 2-Point Deluxe | Evolution® 6100 Hard Hats | ■ Red / White / Blue |
| 281-CS-4PT | 4-Point | Evolution® 6100 Hard Hats | ■ Black |



SUREFIT™ HARD HAT ADAPTER & SAFETY VISORS

- Clips into the universal accessory slots of the hard hat
- Curved plastic channel fits over standard and short brims
- Pivoting blades allow the visor to be lifted up when not in use
- Will fit the JSP® Surefit™ safety visors below
- Can also be used in conjunction with JSP® cap mounted ear muffs
- Meets ANSI Z87.1+ requirements when worn with safety glasses or goggles

HARD HAT ADAPTER

| ITEM NUMBER | COLOR |
|--------------------|---------|
| 251-01-6225 | ■ Black |

SAFETY VISORS

| ITEM NUMBER | COLOR | MATERIAL |
|--------------------|---------|---------------|
| 251-01-6201 | □ Clear | Polycarbonate |
| 251-01-6211 | □ Clear | Acetate |

FOR FACESHIELDS SEE PAGE 212

SUN SHADE EXTENSIONS

- 40 mil dark green front and 30 mil white back
- Forms oval that simply slips over hard hat crown

| ITEM NUMBER | FITS |
|--------------------|---------------------|
| 281-SSE-CAP | Cap Style Hard Hats |
| 281-SSE-FB | Full Brim Hard Hats |



BUMP CAPS

HARDCAP A1+™

HDPE LINER
UNDER BASEBALL
CAP STYLE FOR
BUMP & SCRAPE
PROTECTION



HARDCAP A1+™

BUMP CAP HEAD PROTECTION

IDEAL FOR AREAS WHERE HARD HATS ARE NOT REQUIRED



LOW-PROFILE DESIGN

Ultra-sleek design means the HardCap A1+™ is almost indistinguishable from a low-profile baseball cap.

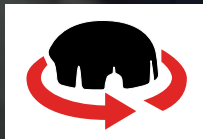

ALL AROUND PROTECTION

The HDPE liner provides protection from front-to-back and side-to-side. The liner is also removable so the outer cap can be washed.

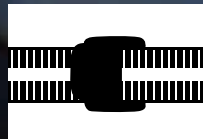

UNIQUE SIZE ADJUSTER

Unique size adjuster slides on an elastic strip to give a quick, secure fit. Angled downward to fit under nape of neck.



SWEATBAND

Terrycloth sweatband adds comfort and absorption for the wearer.



REFLECTIVE PIPING

Reflective piping adds extra visibility and therefore safety in all working environments.

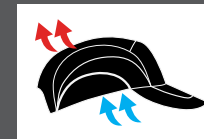

VENTILATION

Holes in the liner match up with mesh panels on the cap to provide added ventilation for coolness and comfort.

HARDCAP A1+™ BUMP CAP

| | | |
|------------------------|--|-----------------|
| KEY FEATURE | Stays On Your Head with Angled Elastic Strap | |
| APPLICATIONS | Assembly Line / Package Handling / Landscaping | |
| CAP STYLE | Low-Profile Baseball | |
| PROTECTIVE LINER | Inner HDPE Liner with Foam Cushioning | |
| SIZE ADJUSTMENT | Elastic Strap with Clamp Action Buckle | |
| VENTILATION | Mesh Panels Match Up with Liner Holes | |
| SWEATBAND | Terry Cloth | |
| STYLE NUMBER | COLOR | BRIM |
| 282-ABR170-62 | Gray / Red | Regular - 2.75" |
| 282-ABR170-21 | Navy / Navy | Regular - 2.75" |
| 282-ABR170-18 | Black / Hi-Vis Orange | Regular - 2.75" |
| 282-ABR170-11 | Black / Black | Regular - 2.75" |
| 282-ABR170-52 | Navy / Yellow | Regular - 2.75" |
| 282-ABR170-12 | Black / Gray | Regular - 2.75" |
| 282-ABR170-CAMO | Camouflage | Regular - 2.75" |
| 282-ABR170-OR | Hi-Vis Orange | Regular - 2.75" |
| 282-ABR170-LY | Hi-Vis Lime Yellow | Regular - 2.75" |
| 282-ABS150-11 | Black / Black | Short - 2" |
| 282-ABS150-12 | Black / Gray | Short - 2" |
| 282-ABS150-18 | Black / Hi-Vis Orange | Short - 2" |
| 282-ABS150-21 | Navy / Navy | Short - 2" |
| 282-ABS150-62 | Gray / Red | Short - 2" |
| 282-ABM130-11 | Black / Black | Micro - 1" |
| 282-ABM130-12 | Black / Gray | Micro - 1" |
| 282-ABM130-21 | Navy / Navy | Micro - 1" |

Bump Caps are **NOT** designed for use in ANSI hard hat designated areas

AVOID BUMPS & SCRAPES

Getting workers to wear head protection can be tough, especially in areas where hard hats are not required. It's estimated that a third of all impact injuries to the head are suffered by workers who bumped into stationary objects while not wearing any head protection. The sporty baseball cap style of the HardCap A1+™ is sure to increase wearer acceptability and reduce injuries.



REGULAR BRIM - 2.75"



REFLECTIVE PIPING+

▲ 282-AES150-21

▲ 282-AEM130-11



▼ 282-AFB375-21

▼ 282-AFB375-LY



SHORT BRIM - 2"



MICRO BRIM - 1"



HI-VIS COLORS



CAMOUFLAGE

HARDCAP AEROLITE™ BUMP CAP

| | | |
|----------------------|--|------------|
| KEY FEATURE | Lightweight & Cool - Weighs Less Than 5 oz. | |
| APPLICATIONS | Assembly / Maintenance / Aviation / Automotive | |
| CAP STYLE | Low-Profile Baseball with Reflective Piping+ | |
| PROTECTIVE LINER | HDPE Shell with EPP Liner | |
| SIZE ADJUSTMENT | Adjustable Elastic Strap | |
| VENTILATION | Large Open Weaved Panels | |
| SWEATBAND | Treated with Polygiene® for Longer Life | |
| STYLE NUMBER | COLOR | BRIM |
| 282-AES150-11 | ■ Black | Short - 2" |
| 282-AES150-21 | ■ Navy | Short - 2" |
| 282-AEM130-11 | ■ Black | Micro - 1" |
| 282-AEM130-21 | ■ Navy | Micro - 1" |

HARDCAP RANGER BUMP CAP

| | | |
|----------------------|--|----------------|
| KEY FEATURE | Shades the Sun's UV Rays | |
| APPLICATIONS | Airlines / Landscapers / Pool Installers | |
| CAP STYLE | 3" Wide Full Brim | |
| PROTECTIVE LINER | Inner HDPE Liner with Foam Cushioning | |
| SIZE ADJUSTMENT | Adjustable Chinstrap | |
| VENTILATION | Mesh Panels Match Up with Liner Holes | |
| SWEATBAND | Terrycloth | |
| STYLE NUMBER | COLOR | BRIM |
| 282-AFB375-21 | ■ Navy / Navy | Full Brim - 3" |
| 282-AFB375-LY | ■ Hi-Vis Lime Yellow | Full Brim - 3" |

THE HARDCAP A1+™ BUMP CAP CAN BE EMBROIDERED WITH YOUR LOGO AND/OR PERSONALIZED MESSAGE.



HARDCAP AEROLITE™ COMFORT PADS 10-PACK

- Replacement padding for hygiene

| | |
|-------------------|--|
| STYLE NUMBER | INCLUDES |
| 282-AEP-10 | 10 Comfort Pads with Spare Hook & Loop Coins |



CLIP-ON LED CAP LIGHT

- Securely clips onto brim of HardCap Bump Cap
- Includes 5 high-power white LEDs that are unbreakable and will last 100,000+ hours

| | |
|--------------------|---------|
| STYLE NUMBER | COLOR |
| 281-CAP-LED | ■ Black |

Batteries included



RESCUE HELMETS

GEAR BAGS / RESCUE HELMETS



▲ 903-GB653
Wheels available only in this style

GEAR BAGS

- "U-shaped" metal stays on the top of the bag to help keep bag open for quick and easy donning and doffing of turn out gear
- Extra-heavy tarp-style bottom with five raised cleats
- Adjustable contoured padded shoulder strap

| ITEM NUMBER | DESCRIPTION |
|------------------|---------------------------|
| 903-GB651 | Red Polyester |
| 903-GB652 | Blue Polyester |
| 903-GB653 | Red Polyester with Wheels |

MULTI-PURPOSE HELMETS INDUSTRIAL / RESCUE



R5SL UTILITY RESCUE HELMET

| | | |
|-----------------|---|----------------------|
| KEY FEATURE | Lightweight Shell with Superior Strength and Durability | |
| APPLICATIONS | Rescue / Industrial | |
| SUSPENSION | Mesh 6-point Ribbon Cradle | |
| SIZE ADJUSTMENT | Ratchet Headband with Padding | |
| SHELL MATERIAL | DuPont® Kevlar™ Composite | |
| CHIN STRAP | 3-Point Polyester with Quick Release Buckle | |
| SWEATBAND | Merino Leather | |
| CERTIFIED | NFPA 1951, EN 397 | |
| COMPLIANT | ANSI/ISEA Z89.1 | |
| STYLE NUMBER | COLOR | ACCESSORIES INCLUDED |
| 856-6323 | Red | ESS Goggle Mounts |
| 856-6324 | Yellow | ESS Goggle Mounts |
| 856-6325 | Blue | ESS Goggle Mounts |
| 856-6326 | White | ESS Goggle Mounts |

R6 DOMINATOR RESCUE HELMET

| | | |
|-----------------|---|----------------------------------|
| KEY FEATURE | Elite Utility Rescue Helmet, Featuring the Open-Close Pacific DSVS™ Dynamic Sealed Ventilation System | |
| APPLICATIONS | Rescue / Industrial | |
| SUSPENSION | 6-Point Ribbon Cradle | |
| SIZE ADJUSTMENT | Ratchet Headband with Padding | |
| SHELL MATERIAL | FiberTuff® Composite | |
| CHIN STRAP | 4-Point Polyester with Quick Release Buckle | |
| EYE PROTECTOR | Internal Retractable | |
| CERTIFIED | EN 12492 | |
| COMPLIANT | ANSI/ISEA Z89.1 | |
| STYLE NUMBER | COLOR | ACCESSORIES INCLUDED |
| 805-3455 | White | Goggle Mounts/Straps, Light Base |
| 805-3479 | Red | Goggle Mounts/Straps, Light Base |



USE THE QR CODE TO

DOWNLOAD THE PIP EMERGENCY RESPONDERS PRODUCTS CATALOG
TO SEE ALL PACIFIC® HELMETS



FIRE & RESCUE HELMETS

STRUCTURAL FIRE HELMETS

UP TO 20% LIGHTER THAN EQUIVALENT WOVEN FIBERGLASS MATERIAL



INCLUDES REFLECTIVE TRIM



FIRE & RESCUE

F10 MKV JET-STYLE STRUCTURAL FIRE HELMET

| | | |
|-----------------|--|-----------------------------------|
| KEY FEATURE | Internal Bubble Face Shield & One Touch™ Eye Protector | |
| APPLICATIONS | Fire & Rescue | |
| SUSPENSION | 6-Point Ribbon Cradle | |
| SIZE ADJUSTMENT | Ratchet Headband with Easy-to-Adjust Dial | |
| SHELL MATERIAL | DuPont® Kevlar™ Composite | |
| CHIN STRAP | 3-Point Nomex® | |
| SWEATBAND | Leather | |
| CERTIFIED | NFPA 1951, NFPA 1971, EN 443 | |
| COMPLIANT | ANSI/ISEA Z89.1 | |
| STYLE NUMBER | COLOR | ACCESSORIES INCLUDED |
| 841-0401 | ■ White | Bubble Face Shield, Eye Protector |
| 841-0398 | ■ Red | Bubble Face Shield, Eye Protector |
| 841-0400 | ■ Black | Bubble Face Shield, Eye Protector |
| 841-0399 | ■ Yellow | Bubble Face Shield, Eye Protector |

F6 METRO STYLE STRUCTURAL FIRE HELMET

| | | |
|-----------------|---|---------------------------|
| KEY FEATURE | Most Popular Structural Fire Helmet Style | |
| APPLICATIONS | Fire & Rescue | |
| SUSPENSION | Impact Liner with Mesh Cradle | |
| SIZE ADJUSTMENT | Ratchet Headband | |
| SHELL MATERIAL | FiberTuff® Composite Fiberglass | |
| CHIN STRAP | 2-Point Nomex® | |
| CERTIFIED | NFPA 1971 | |
| COMPLIANT | ANSI/ISEA Z89.1, EN 166 | |
| STYLE NUMBER | COLOR | ACCESSORIES INCLUDED |
| 828-0378 | ■ White | Retractable Eye Protector |
| 828-0379 | ■ Red | Retractable Eye Protector |
| 828-0382 | ■ Black | Retractable Eye Protector |
| 828-0380 | ■ Yellow | Retractable Eye Protector |

DUPONT™ KEVLAR® COMPOSITE RESIN SHELL FOR SUPERIOR STRENGTH & DURABILITY

WINTER LINERS

FR TREATED

WINTER LINERS FEATURES & BENEFITS



MATERIAL & CONSTRUCTION

Winter liners are available in 1, 2, or 3 layer constructions.

OUTER LAYERS

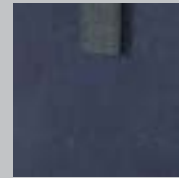

Cotton Twill



Polyester (Quilted)

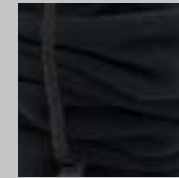

Polyester Fleece

INNER LAYERS



Fleece



Sherpa Pile Fleece

LENGTHS



Regular Length (Shorty):

Hits at base of head



Mid-Length (Middy)

Hits just below nape of neck



Shoulder Length (Extended):

Wraps around to front and can be tucked into jacket

FR TREATMENT

• FR Treated (Outer shells only):

- Outer shell tested to retain their FR characteristics for 1, 10, or 30 washes

• Non-FR:

- Hats, caps and a few select winter liners are not treated for use in applications that do not require the added protection



USE WITH **NEW HEAT PACKS** | PAGE 119

SELECT A LINER BY LEVEL OF WARMTH

WARM

WARMER

WARMEST

WARM

| STYLE NUMBER | TYPE | LENGTH | COLOR | LAYERS | OUTER | MIDDLE | INNER |
|---------------------------|-----------|----------|--------|--------|--------------|--------|--------|
| 364-SL1FB | Non-FR | Extended | ■ Navy | 1 | Fleece | --- | --- |
| 363-1RL2B | 1 Wash | Regular | ■ Navy | 2 | Cotton Twill | --- | Fleece |
| 364-RL2B | 30 Washes | Regular | ■ Navy | 2 | Cotton Twill | --- | Fleece |

WARMER

| | | | | | | | |
|----------------------------|-----------|--------------------------------------|---------|---|------------------|--------|--------------|
| 364-1170 | Non-FR | Extended Adjustable 3-in-1 Balaclava | ■ Black | 1 | Polyester Fleece | --- | --- |
| 363-1RL3QB | 1 Wash | Regular - Quilted | ■ Black | 3 | Polyester | Foam | Fleece |
| 363-1ML2FB | 1 Wash | Mid | ■ Navy | 2 | Cotton Twill | --- | Fleece |
| 363-1SL2FB | 1 Wash | Extended | ■ Navy | 2 | Cotton Twill | --- | Fleece |
| 364-RL3QB | 10 Washes | Regular Quilted | ■ Black | 3 | Polyester | Foam | Fleece |
| 365-1620 | 10 Washes | Mid Zipper 2-in-1 | ■ Navy | 2 | Cotton Twill | Fleece | Acrylic Neck |
| 364-ML2FB | 30 Washes | Mid | ■ Navy | 2 | Cotton Twill | --- | Fleece |
| 364-SL2FB | 30 Washes | Extended | ■ Navy | 2 | Cotton Twill | --- | Fleece |

WARMEST

| | | | | | | | |
|----------------------------|-----------|------------------|--------|---|--------------|-----|-------------|
| 364-ML2FMP | 30 Washes | Mid - Mouthpiece | ■ Navy | 2 | Cotton Twill | --- | Fleece |
| 364-ML2SB | 30 Washes | Mid | ■ Navy | 2 | Cotton Twill | --- | Sherpa Pile |
| 364-SL2SB | 30 Washes | Extended | ■ Navy | 2 | Cotton Twill | --- | Sherpa Pile |

STYLES WITH ADDITIONAL FEATURES



▲ [364-ML2FMP](#)
Middy with Mouthpiece



▲ [364-1170](#)
3-in-1 Balaclava



▲ [365-1620](#)
Zippered On/Off FR Liner

BEST SELLER

PROTECTION FROM THE COLD OUTDOORS OR INDOORS

IDEAL FOR INDUSTRIAL, CONSTRUCTION & SERVICE WORKERS



▲ [365-1510FR-BK](#)



▲ [365-1520FR-BK](#)



▲ [360-BEANNIELY](#)



WINTER HAT LINERS

- Knit Material
- FR and Non FR
- One Size Fits Most

FR/AR WINTER HATS & LINERS (ARC RATED)

| ITEM NUMBER | DESCRIPTION | ARC RATING | COLOR |
|-------------------------------|------------------------------|------------------------|---------|
| 360-1500FR-BK | FR Knit Watch Cap | 33 cal/cm ² | ■ Black |
| 365-1510FR-BK | FR Knit Hard Hat Tube Liner | 15 cal/cm ² | ■ Black |
| 365-1520FR-BK | FR Knit Full Face Tube Liner | 15 cal/cm ² | ■ Black |

NON FR WINTER HATS & LINERS

| | | | |
|-------------------------------|--|--|----------------------|
| 365-1502-BK | Knit Full Face Tube Liner | | ■ Black |
| 365-1505-BK | Knit Hard Hat Tube Liner | | ■ Black |
| 360-BEANNIELY | Winter Beanie Cap with Reflective Stripe | | ■ Hi-Vis Lime Yellow |
| 360-BEANNIEOR | Winter Beanie Cap with Reflective Stripe | | ■ Hi-Vis Orange |

FLAME & FIRE RESISTANT HOODS

NOMEX® / NFPA 1971



FLAME RESISTANT HOODS



SLIT EYE

▲ 202-130

◀ NOMEX® FLAME RESISTANT HOODS

- Offer limited chemical splash protection along with excellent wear and durability
- Meets OSHA Requirements for flame resistance
- Protective properties will not wash out
- All Bibs are 6", front and back

APPLICATIONS: *Chemical Plants, Metal and Glass Manufacturing, Natural Gas Production and Distribution, Law Enforcement*



FULL FACE

▲ 202-101

100% NOMEX® FR HOODS

| STYLE NUMBER | COVERAGE | LAYER | BIB | COLOR | SIZES |
|----------------|-----------|--------|---------|---------|-------|
| 202-100 | Full Face | Single | Without | ■ White | OSFM |
| 202-101 | Full Face | Single | Without | □ Black | OSFM |
| 202-102 | Full Face | Double | Without | ■ White | OSFM |
| 202-110 | Full Face | Single | With | ■ White | OSFM |
| 202-112 | Full Face | Double | With | ■ White | OSFM |
| 202-130 | Slit Eye | Single | With | ■ White | OSFM |
| 202-132 | Slit Eye | Double | With | ■ White | OSFM |

FIRE RESISTANT HOODS



▲ 906-100NOM7BLKB

▲ 906-2080NOL7B

◀ 100% NOMEX® HOODS

- Excellent for flash protection along with superior wear and durability
- Protective properties will not wash out

APPLICATIONS: *Structural Firefighting, Chemical Plants, Metal and Glass Manufacturing, Natural Gas Production and Distribution, Law Enforcement*

◀ 20% NOMEX® / 80% LENZING FR® HOODS

- Fabric combination provides comfort and breathability

NFPA 1971 CERTIFIED HOODS

| STYLE NUMBER | TPP RATING | MATERIAL | CUT | COVERAGE | LAYER | BIB | COLOR | SIZES |
|-------------------------|------------|------------------------------|--------------|-----------|--------|------|---------|-------|
| 906-100NOM7 | 20-23 | 100% Nomex® | Tri-Cut | Full Face | Double | With | ■ White | OSFM |
| 906-100NOM7B | 20-23 | 100% Nomex® | Straight Cut | Full Face | Double | With | ■ White | OSFM |
| 906-100NOM7BLKB | 20-23 | 100% Nomex® | Straight Cut | Full Face | Double | With | □ Black | OSFM |
| 906-2080NOL7 | 17 | 20% Nomex® / 80% Lenzing FR® | Tri-Cut | Full Face | Single | With | ■ White | OSFM |
| 906-2080NOL7B | 17 | 20% Nomex® / 80% Lenzing FR® | Straight Cut | Full Face | Single | With | ■ White | OSFM |
| 906-2080NOL7BLK | 23 | 20% Nomex® / 80% Lenzing FR® | Tri-Cut | Full Face | Single | With | □ Black | OSFM |
| 906-2080NOL7BLKB | 23 | 20% Nomex® / 80% Lenzing FR® | Straight Cut | Full Face | Single | With | □ Black | OSFM |
| 906-8416CBX | 28 | 84% Carbon® / 16% Technora® | Straight Cut | Full Face | Single | With | □ Black | OSFM |
| 906-8416CT | 28 | 84% Carbon® / 16% Technora® | Tri-Cut | Full Face | Single | With | □ Black | OSFM |

HEARING PROTECTION & WHY IT'S CRITICAL

WHEN THE NOISE LEVELS OF A WORK ENVIRONMENT EXCEED 85 DECIBELS (dB), THE RISK OF HEARING LOSS BECOMES VERY PREVALENT AND HEARING PROTECTION SHOULD BE WORN. AT THE SAME TIME “TOO MUCH” HEARING PROTECTION CAN ALSO BE DANGEROUS, AS IT RESTRICTS THE WEARER FROM HEARING THEIR COLLEAGUES OR MOVING VEHICLES IN THEIR WORK AREA. TAKING THIS INTO CONSIDERATION, THE IDEAL NOISE LEVEL IS 70-85 dB.

Hearing loss is both cumulative and gradual, meaning hearing can continually worsen and that it is difficult for someone to be aware of if they are losing their hearing. Therefore, it is critical to wear hearing protection to better sustain one's hearing. By preserving the hearing one has, they help reduce the impact of hearing loss in their day-to-day life.

HEARING PROTECTION OPTIONS: EAR PLUGS AND EAR MUFFS

Ear plugs are the most popular choice because they are seen as the most economical solution and they can easily be worn with other PPE.

- **Single Use Ear Plugs** are ideal for use in high-contamination environments and by work-site visitors.
- **Multiple Use Ear Plugs** are reusable and easy to clean, making them ideal for use in manufacturing, construction, and MRO.
- **Corded and Uncorded** options are available in both families. Uncorded is more economical, while the corded plugs are easier to keep track of by allowing the user to wear the ear plugs around their neck when they are not in use.

The correct use of ear plugs is critical to ensuring optimal performance, and we encourage proper training and practice to achieve this. Improper use can minimize or negate the hearing protection properties of the ear plug and expose the wearer to potential hearing loss.

ALL PIP HEARING PROTECTION PRODUCTS HAVE A NOISE REDUCTION RATING (NRR)

Ear muffs provide a more secure form of hearing protection, especially because they are easier to use and allow the user to gain maximum protection from the product. There are two types of ear muffs: passive and active.

- **Electronic Ear Muffs** feature an electronic protection system that digitally limits all sound through the internal speakers to a safe level. Models with Active Listening, allow you to communicate with others or hear warning signals while protected against impulsive or intermittent hazardous noise.
- **Passive muffs** do not have any electronic features, and are available in headband, neckband, and cap mounted styles – the latter two can be worn with a hard hat.

168 EAR MUFFS

170 EAR PLUGS

172 ADDITIONAL STYLES &
ACCESSORIES

HEARING PROTECTION

EAR MUFFS

SECURE™ PASSIVE



SECURE™

PASSIVE EAR MUFFS



- Offered in three levels of protection clearly indicated with bright safety colors for easy identification and performance selection
- Smooth telescopic single-point size adjustment increases comfort, performance and wear time
- Ear and headband cushions feature snap-in system for easy replacement
- All models are dielectric, non-conductive

| | SECURE™ HEADBAND | SECURE™ CAP MOUNTED | SECURE™ NECKBAND |
|------------------------|--|--|--|
| STYLE NUMBERS | 263-41003 NRR 28 dB - Secure 3 - Orange 263-41002 NRR 26 dB - Secure 2 - Yellow 263-41001 NRR 23 dB - Secure 1 - Green | 263-42003 NRR 27 dB - Secure 3 - Orange 263-42002 NRR 24 dB - Secure 2 - Yellow 263-42001 NRR 22 dB - Secure 1 - Green | 263-43003 NRR 27 dB - Secure 3 - Orange 263-43002 NRR 25 dB - Secure 2 - Yellow 263-43001 NRR 23 dB - Secure 1 - Green |
| KEY FEATURE | Telescopic Single-Point Headband Size Adjustment | Easily Adjusts to Three Wearing Positions: Usage, Stand-By & Storage | Can Be Worn with Full Brim Hard Hats & Other Specialty Headgear |
| APPLICATIONS | Manufacturing / Construction / Industrial | Construction / Industrial | Manufacturing / Construction / Industrial |
| SIZE ADJUSTMENT | Single-Point 7-Position | Single-Point 5-Position | Head Support Hook & Loop Strap |
| CUSHIONS | Snap-In Ear & Headband Cushions | Snap-In Ear Cushions | Snap-In Ear Cushions |
| DIELECTRIC | Yes | Yes | Yes |
| PACKAGING | Boxed | Boxed | Boxed |

AVAILABLE WITH
ACTIVE LISTENING | **AM/FM RADIO**



SECURE™



ELECTRONIC EAR MUFFS

- Active Listening is a Level Dependent System that allows you to communicate with others or hear warning signals while protected against impulsive or intermittent hazardous noise
- Level-dependent microphones mounted on each ear cup ensure excellent directional hearing
- Electronic Protection System (EPS) limits all sounds reproduced through the speakers to a safe sound level
- All electronic models include a 3.5 mm external sound input for radio communications, as well as MP3 players and other common devices



HEAD BAND



CAP MOUNTED



| | SECURE™ ACTIVE | SECURE™ RELAX | SECURE™ REACT |
|-----------------------------|--|--|--|
| STYLE NUMBERS | 264-47002 NRR 24 dB - Headband - ■ Yellow | 264-45002 NRR 24 dB - Headband - ■ Yellow | 264-46002 NRR 24 dB - Headband - ■ Yellow |
| | 264-47102 NRR 23 dB - Cap Mount - ■ Yellow | 264-45102 NRR 23 dB - Cap Mount - ■ Yellow | 264-46102 NRR 23 dB - Cap Mount - ■ Yellow |
| KEY FEATURE | Level Dependent System Allows You to Communicate with Others | Offers Hearing Protection with Built-In AM/FM Radio | Includes Both Level Dependent System & AM/FM Radio |
| APPLICATIONS | Manufacturing / Construction / Industrial | Manufacturing / Construction / Industrial | Manufacturing / Construction / Industrial |
| ACTIVE LISTENING | Yes | No | Yes |
| AM/FM RADIO WITH AFC | No | Yes | Yes |
| SIZE ADJUSTMENT | Single-Point Telescopic | Single-Point Telescopic | Single-Point Telescopic |
| EAR CUSHIONS | Snap-In Ear and/or Headband Cushions | Snap-In Ear and/or Headband Cushions | Snap-In Ear and/or Headband Cushions |
| EXTERNAL SOUND INPUT | 3.5 mm | 3.5 mm | 3.5 mm |
| BATTERIES | Two "AA" Included | Two "AA" Included | Two "AA" Included |
| PACKAGING | Boxed | Boxed | Boxed |

EAR PLUGS

SINGLE-USE

SINGLE-USE

COMMONLY USED & PROVIDE ADDED HYGIENIC VALUE



NRR
32



NRR
30



NRR
30



NRR
32

X-EMBOSS

COMPACT X-EMBOSS

TRADITIONAL PVC

ECONOMY BULLET

| | | | | |
|---------------|---|---|--|--|
| STYLE NUMBERS | 267-HPF200 NRR 32 dB - Uncorded - 200 pair | 267-HPF300 NRR 30 dB - Uncorded - 200 pair | 267-HPF700 NRR 30 dB - Uncorded - 200 pair | 265-200U NRR 32 dB - Uncorded - 200 pair |
| | 267-HPF200C NRR 32 dB - Corded - 100 pair | 267-HPF300C NRR 30 dB - Corded - 100 pair | 267-HPF700C NRR 30 dB - Corded - 100 pair | 265-100C NRR 32 dB - Corded - 100 pair |
| | 267-HPF200-1 Dispenser Refill Pack NRR 32 dB - Uncorded - 300 pair | 267-HPF300-1 Dispenser Refill Pack NRR 30 dB - Uncorded - 300 pair | | |
| KEY FEATURE | X-Embossed on End, Reduces Pressure at Ear Canal Opening | Smaller Contoured Design for Narrower Ear Canals | Classic Cylindrical Design in PVC Foam Plug | Economical Choice |
| APPLICATIONS | Manufacturing / Construction / Industrial | Manufacturing / Construction / Industrial | Manufacturing / Construction / Industrial | Manufacturing / Construction / Industrial |
| STYLE | Disposable | Disposable | Disposable | Disposable |
| COLOR | ■ Lime | ■ Magenta | ■ Orange | ■ Orange |
| MATERIAL | Polyurethane Foam (PU) | Polyurethane Foam (PU) | PVC Foam | Polyurethane Foam (PU) |
| SHAPE | Tapered with X-Emboss | Compact Contoured with X-Emboss | Cylindrical | Tapered |
| CORD TYPE | Uncorded or Black PVC Cord | Uncorded or Black PVC Cord | Uncorded or Black PVC Cord | Uncorded or Red PVC Cord |
| PACKAGING | Individual Poly Bagged Pairs in Dispenser Box | Individual Poly Bagged Pairs in Dispenser Box | Individual Poly Bagged Pairs in Dispenser Box | Individual Poly Bagged Pairs in Dispenser Box |

MULTIPLE USE

EASY TO CLEAN, REDUCE WASTE & SAVE MONEY



| | REUSABLE | | DETECTABLE | | BANDED | |
|----------------------|--|--|---|--|---|--|
| | FLANGE CLASSIC | FLANGE/DISC COMBO | METAL DETECTABLE X-EMBOSS | METAL DETECTABLE FLANGE/DISC COMBO | BANDED OVAL FOAM | BANDED FLANGE REUSABLE |
| STYLE NUMBERS | 267-HPR200 NRR 23 dB - Uncorded - 100 pair | 267-HPR300 NRR 25 dB - Uncorded - 100 pair | 267-HPF200D NRR 32 dB - Corded - 100 pair | 267-HPR300D NRR 25 dB - Corded - 100 pair | 267-HPB200 NRR 20 dB - 10 pair | 267-HPB300 NRR 20 dB - 10 pair |
| | 267-HPR200C NRR 23 dB - Corded - 100 pair | 267-HPR300C NRR 25 dB - Corded - 100 pair | | | | |
| KEY FEATURE | Pre-Formed Plug Shape with No Rolling Required | Self-Sealing Flanges & Discs with a Higher NRR | Includes Traceable Metal Insert | Bright Blue Color Makes it Easier to See In Production Areas | Oval Foam Plug Fits Shape of the Ear Canal Snugly | Reusable Version Can Be Worn Under Chin or Behind the Neck |
| APPLICATIONS | Manufacturing / Construction / Dirty Environments | Manufacturing / Construction / Dirty Environments | Food Industry | Food Industry | Frequent Use / Visitors / Industrial | Frequent Use / Visitors / Industrial |
| STYLE | Reusable | Reusable | Disposable | Reusable | Banded - Disposable | Banded - Reusable |
| COLOR | Orange | Lime | Blue | Blue | Lime | Red |
| MATERIAL | TPE (thermoplastic elastomer) | TPE (thermoplastic elastomer) | Polyurethane Foam (PU) | TPE (thermoplastic elastomer) | Polyurethane Foam (PU) | TPE (thermoplastic elastomer) |
| SHAPE | Self-Sealing Flanges | Self-Sealing Flanges & Discs | Tapered w/ X-Emboss | Self-Sealing Flanges & Discs | Oval Cap | Self-Sealing Flanges |
| CORD TYPE | Uncorded or Textile Cord | Uncorded or Textile Cord | Blue PVC Cord | Blue PVC Cord | Ergonomic Blue Band | Black Band |
| PACKAGING | Individual Poly Bagged Pairs in Box | Individual Poly Bagged Pairs in Box | Individual Poly Bagged Pairs in Box | Individual Poly Bagged Pairs in Box | Individual Poly Bagged Pairs in Box | Individual Poly Bagged Pairs in Box |

HEARING PROTECTION

ADDITIONAL STYLES / ACCESSORIES



INTER GPV™ GENERAL PURPOSE

| STYLE NUMBERS | 262-AEK010HV NRR 20 dB - Cap Mounted - ■ Orange | 262-AEK020HV NRR 24 dB - Cap Mounted - ■ Orange | 262-AEJ030-50 NRR 21 dB - Cap Mounted - ■ Blue |
|-----------------|---|---|--|
| KEY FEATURE | Hi-Vis Orange for Extra Visibility | Hi-Vis Orange for Extra Visibility | Allow Attachment of Safety Visor When Used with Surefit™ Adapter |
| APPLICATIONS | Construction / Industrial | Construction / Industrial | Construction / Industrial |
| SIZE ADJUSTMENT | Twin-Point Mount with Tilt | Twin-Point Mount with Tilt | Single-Point with Pivot/Slide |
| PACKAGING | Boxed | Boxed | Boxed |

INTER EXV™ EXTREME

SUREFIT™ CONTOUR™

EAR PLUG DISPENSER

Wall-mounted dispenser holds 600 pairs (not included)

- Controlled-release mechanism ensures the correct number of plugs is dispensed into a collection tray
- Audible 1-2-click system prevents oversupply and reduces waste costs
- Simple to open and fill dispenser with disposable PU foam ear plug refill packs, HPF200 (NRR 32 dB) or compact HPF300 (NRR 30 dB)

| STYLE NUMBER | STYLE |
|---------------------|---------------------------------|
| 267-HPD100 | Dispenser |
| 267-HPF200-1 | Refill Pack - HPF200 (300 pair) |
| 267-HPF300-1 | Refill Pack - HPF300 (300 pair) |



ECONOMY HEADBAND

One of the lightest ear muffs on the market, weighing in at only 5.5 oz.

- Intended for long-term use in low noise levels, or shorter periods in medium-noise environments
- Single-point attachment distributes pressure and seal evenly around the ear
- Comfortable pressure-equalizing headband ensures the cups remain in proper position during use

| STYLE NUMBER | NRR | STYLE | COLOR |
|------------------|-------|----------|--|
| 263-11001 | 22 dB | Headband | ■ Red |



HYGIENE KITS - SECURE™ EAR MUFFS

Ear and headband cushions feature snap-in system for easy replacement

- All Hellberg® Secure™ hygiene kits include one pair of replacement ear cushions, one pair of foam inserts and one headband cushion
- Ear cushions should be replaced twice a year, or when the cushion shows signs of damage

| STYLE NUMBER | STYLE |
|------------------|--------------------|
| 263-99400 | Secure™ 1 & 2 |
| 263-99401 | Secure™ 3 |
| 264-99403 | Secure™ Electronic |

FUNDAMENTALS OF EYE PROTECTION

EYE PROTECTION IS DESIGNED TO HELP SHIELD YOUR EYES FROM CERTAIN IMPACTS, DEBRIS, DUST, SPLASHES, AND OTHER POTENTIAL HAZARDS THAT COULD PRESENT SEVERE INJURY TO THE EYES, INCLUDING POTENTIAL BLINDNESS. PIP'S BOUTON® OPTICAL PROVIDES A COMPREHENSIVE LINE OF POTENTIAL SOLUTIONS FOR SAFETY EYEWEAR NEEDS.

SAFETY GLASSES

In addition to temples and nose pads to improve fit and comfort, there are several options also available to meet specific needs:

- **Readers** are available in different diopters and help magnify text so it becomes easier to read.
- **Foam-Lined Safety Glasses** seal better against the wearer's face, helping better protect against dust and other small debris. This style of eye protection is not recommended for splash protection.
- **Over-The-Glass (OTG) Safety Glasses** can be worn over prescription eyewear to provide the required protection. Standard eyeglasses cannot act as safety glasses and should not be treated as such.
- **Dielectric Safety Glasses** do not contain any metal components, making them non-conductive for those who are working near or around electricity.

Once the style of protective eyewear is chosen, the next consideration should be the lens technology for the task at hand. Depending on the work environment and lighting conditions, there are several different options for lenses. This information is detailed in the Bouton® Optical Lens Treatment Quick Guide on the subsequent pages.

GOGGLES & FACE SHIELDS

With goggles, the type of venting required for the work environment is the most critical consideration.

- **Direct Vented** goggles help minimize fogging and should be used when there is no liquid splash risk. Direct vented goggles have straight-line perforations that allow direct airflow from the work environment.
- **Indirect Vented** goggles help minimize fogging and should be used when there is liquid splash risk. Indirect vented goggles have hooded vents to allow indirect airflow from the work environment.
- **Non-Vented** have no openings for airflow or ventilation.

Face shields do just that – they protect the face from debris, such as sparks, or certain impacts. Face shields should not be used as a replacement for safety eyewear, as they are designed to be used in conjunction with eye protection products. Face shields can be worn with standard head gear or they can be fitted on your hard hat with the assistance of an adapter or bracket.

[174 LENS TECHNOLOGIES](#)

[178 SAFETY GLASSES](#)

[208 SAFETY GOGGLES](#)

[212 FACE PROTECTION](#)

[214 ACCESSORIES](#)

bouton
OPTICAL

ALL BOUTON SAFETY EYEWEAR
MEETS ANSI Z87.1-2015 STANDARDS

EYE & FACE PROTECTION



bouton[®] OPTICAL

FOR OVER 60 YEARS,
BOUTON[®] HAS BUILT ITS NAME
BY DEVELOPING SAFETY GLASSES
WORKERS WANT TO WEAR. BY
FOCUSING ON INNOVATION AND
STYLE, THE BOUTON[®] LEGACY
CONTINUES TO GROW TODAY.

BOUTON[®]
LENS TECHNOLOGIES



ANTI-REFLECTIVE PLUS[™] TECHNOLOGY

THE CLOSEST THING TO
NOT WEARING GLASSES

Bouton[®] Anti-ReflectivePLUS[™] lenses allow an astounding 96% Visible Light Transmission (VLT) compared to the 88–90% VLT provided by standard clear lenses. Durable Anti-ReflectivePLUS[™] Anti-Reflective coating significantly reduces the amount of light that reflects back into the wearer's eyes, providing ultimate visual acuity. Inspect, distinguish and see with more clarity—and less eye fatigue.

Available in the Following Styles: Bullseye, Recon, Commander, Supersonic, Q-Vision, Radar, Captain

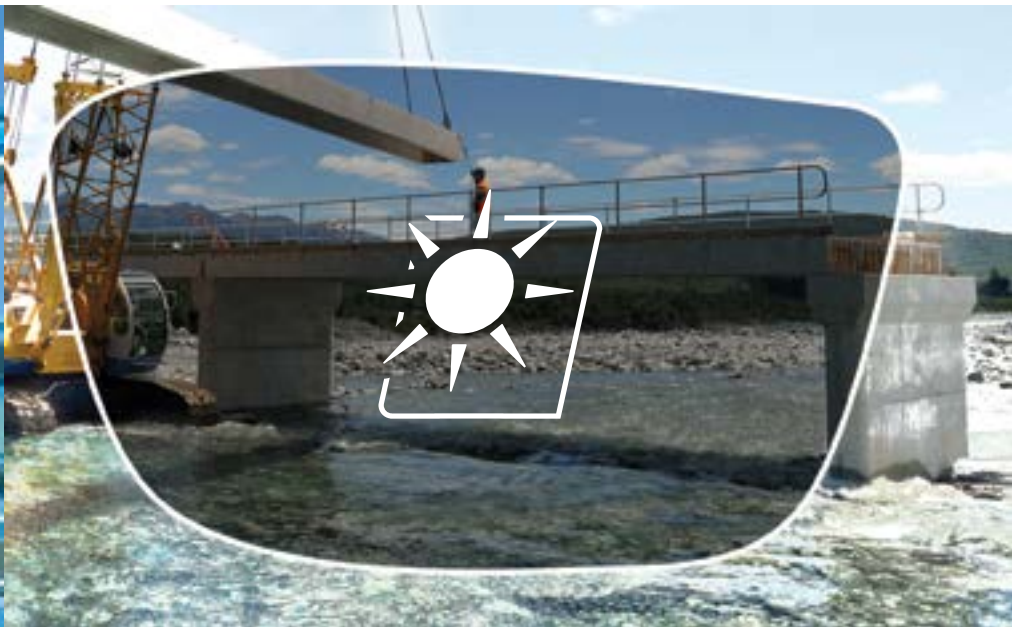

TAKE ANTI-REFLECTIVE PLUS™ TECHNOLOGY OUTDOORS WITH MIRROR PLUS LENSES

A mirror coating on the face of the lens will deflect sunlight from the wearer's eyes, delivering noticeably less glare and reflection than standard gray lenses. Anti-ReflectivePLUS™ coating on the back of the lens significantly reduces light reflecting back into the eye for enhanced comfort and performance.

Available in the Following Styles: Sunburst, Squadron, Bond



FILTER REFLECTED SUNLIGHT FOR A CLEAR VIEW

Reflected sunlight from smooth surfaces, such as water, pavement, and snow can dangerously hinder vision and cause significant eyestrain. PolarizedXL5™ lenses filter the scatter light by controlling the angle at which it enters the lens. The result is clearer vision of the surrounding area and greatly reducing eye glare.

Available in the Following Styles: Commander, Sunburst



I/O BLUE
TECHNOLOGY

PROTECT AGAINST HARMFUL BLUE LIGHT

Overexposure to blue light, including smart phones, tablets and computer screens, has been known to cause eyestrain, fatigue and possibly contribute to long term macular degeneration. I/O Blue lenses are uniquely coated to help filter out harsh blue light and improve worker comfort and visual acuity. Lenses are also treated with a contrast booster to enhance color contrast.

Available in the Following Styles: Bullseye, Recon, Commander, Supersonic, Q-Vision, Radar, Captain, Bond, Blizzard



GRADIENT™
TECHNOLOGY

REDUCE GLARE FROM OVERHEAD LIGHT

High-powered overhead lights, such as fluorescent and mercury lighting, can cause glare that increases eye strain. Gradient lenses feature a slight mirror coating on the top portion of the lens, reducing glare, while the remainder of the lens remains clear. As a result, workers are still able to see clearly when looking straight ahead or down at their work.

Available in the Following Styles: Bullseye, Recon, Supersonic

IT'S NOT LESS FOG IT'S FOGLESS®



Lenses fog for many reasons, all of which are related to ambient temperature and moisture in the air. When a rapid temperature change occurs, micro-water droplets in the air will collect on untreated lenses, causing the lenses to fog and impede vision.

FOGLESS® 3SIXTY™ TECHNOLOGY PROVIDES THE ULTIMATE FOG PREVENTION WHEN:

- Transitioning between warm and cool environments
- Working in a humid or wet environment
- Engaging in an activity that causes perspiration
- Eye protection is used with respiratory equipment

FogLess® 3Sixty™ Technology

Standard Anti-Fog

THE CHOICE IS CLEAR

BOUTON® FOGLESS® 3SIXTY™ was tested in accordance to procedures outlined in the European EN 166 standard in performing this test, lenses were pre-treated and repeatedly exposed to moisture for an extensive period, wiping continually to simulate harsh field conditions.

FOGLESS® 3SIXTY™ REMAINED CLEAR EVEN AFTER SIX MINUTES OF TESTING, NO OTHER PRODUCT WITH STANDARD ANTI-FOG TREATMENT CAME CLOSE.



Most eyewear on the market has only a light anti-fog coating that wears away quickly. Only Bouton® FogLess® 3Sixty™ Technology applies a densely bonded coating that continues to bead away water and moisture, even after repeated cleaning.



Lens fogging inhibits vision and productivity, which may result in workers removing their safety glasses - exposing their eyes to debris and impact. PIP's advanced FogLess® 3Sixty™ formulation was developed to adhere permanently to the lens, ensuring long-lasting performance that is able to withstand multiple lens cleanings.

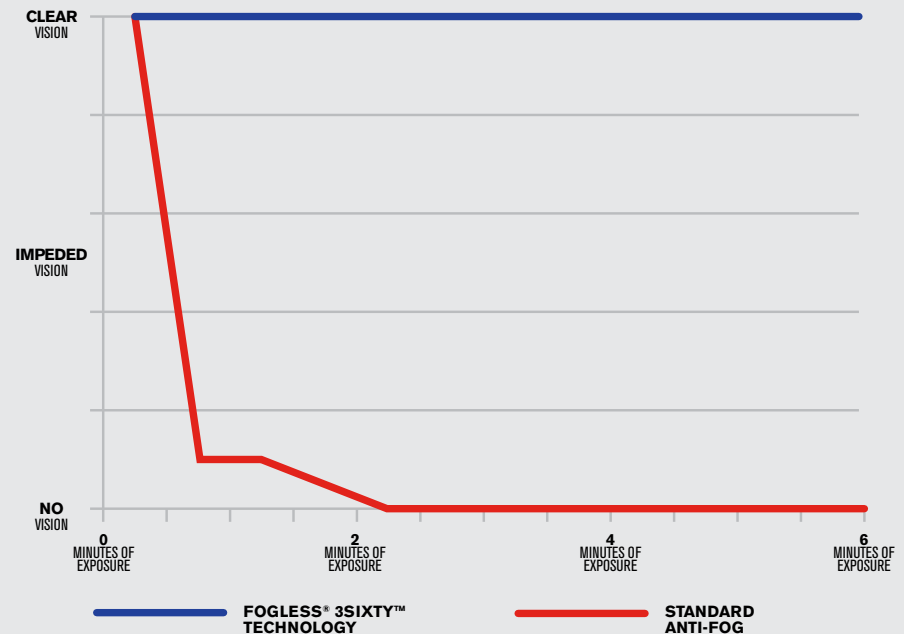



DARE TO BE BOLD



SUNBURST™

MEETS ANSI
Z87.1+

- :: Lightweight, full frame design offers all day comfort
- :: Bayonet temples are rubber co-molded for a secure fit
- :: Non-slip rubber nose pads provide long-wear comfort
- :: Anti-fog coating is standard on most models
- :: 8 base curve

LENS TECHNOLOGY



bouton
OPTICAL

| STYLE NUMBER | LENS | COATING | FRAME |
|-----------------------------|--|-------------------------|--------------------------------|
| 250-47-0041 | <input type="checkbox"/> Gray Polarized XL5™ Technology | Anti-Scratch / Anti-Fog | <input type="checkbox"/> Black |
| 250-47-0004 | <input checked="" type="checkbox"/> Red Mirror Plus™ Technology | Anti-Scratch | <input type="checkbox"/> Black |
| 250-47-0005 | <input checked="" type="checkbox"/> Silver Mirror Plus™ Technology | Anti-Scratch | <input type="checkbox"/> Black |
| 250-47-0006 | <input checked="" type="checkbox"/> Blue Mirror Plus™ Technology | Anti-Scratch | <input type="checkbox"/> Black |
| 250-47-0007 | <input checked="" type="checkbox"/> Gold Mirror Plus™ Technology | Anti-Scratch | <input type="checkbox"/> Black |
| 250-47-0020 | <input checked="" type="checkbox"/> Clear | Anti-Scratch / Anti-Fog | <input type="checkbox"/> Black |
| 250-47-0021 | <input checked="" type="checkbox"/> Gray | Anti-Scratch / Anti-Fog | <input type="checkbox"/> Black |
| 250-47-1008 | <input checked="" type="checkbox"/> Green Mirror Plus™ Technology | Anti-Scratch / Anti-Fog | <input type="checkbox"/> Brown |
| 250-47-1042 | <input type="checkbox"/> Brown Polarized XL5™ Technology | Anti-Scratch / Anti-Fog | <input type="checkbox"/> Brown |



WORK & ADVENTURE

SQUADRON™

MEETS ANSI
Z87.1+

- :: Full frame style designed to provide a universally comfortable fit
- :: Nylon bayonet temples eliminate pressure for all day comfort
- :: Stylish design looks good for work and leisure
- :: Dielectric design contains no metal parts
- :: Anti-fog coating is standard on most models
- :: 8.5 base curve

LENS TECHNOLOGY



| STYLE NUMBER | LENS | COATING | FRAME |
|-----------------------------|--------------------------------|-------------------------|--------------------------------|
| 250-53-0020 | ■ Clear | Anti-Scratch / Anti-Fog | <input type="checkbox"/> Black |
| 250-53-0021 | ■ Gray | Anti-Scratch / Anti-Fog | <input type="checkbox"/> Black |
| 250-53-0022 | ■ I/O | Anti-Scratch / Anti-Fog | <input type="checkbox"/> Black |
| 250-53-0006 | ■ Blue Mirror Plus™ Technology | Anti-Scratch | <input type="checkbox"/> Black |
| 250-53-1024 | ■ Brown | Anti-Scratch / Anti-Fog | <input type="checkbox"/> Camo |



CAMO FRAME AVAILABLE

bouton
OPTICAL

MODERN CLASSIC

BOND™

MEETS ANSI
Z87.1+

- :: Lightweight nylon frame provides ultimate comfort with practically no pressure behind the ear
- :: Keyhole bridge design sits naturally on the nose to fit many different faces
- :: Latest design trend in premium eye wear
- :: Dielectric materials and parts contain no metal
- :: Anti-fog coating is standard on most models
- :: 8.5 base curve

LENS TECHNOLOGY



| STYLE NUMBER | LENS | COATING | FRAME |
|--------------------|---------------------------------|-------------------------|------------|
| 250-57-0020 | ■ Clear | Anti-Scratch / Anti-Fog | ■ Charcoal |
| 250-57-0021 | ■ Gray | Anti-Scratch / Anti-Fog | ■ Charcoal |
| 250-57-0226 | ■ I/O Blue Technology | Anti-Scratch / Anti-Fog | ■ Charcoal |
| 250-57-0004 | ■ Red Mirror Plus™ Technology | Anti-Scratch | ■ Charcoal |
| 250-57-0008 | ■ Green Mirror Plus™ Technology | Anti-Scratch | ■ Charcoal |



bouton
OPTICAL

COMMANDER™

- :: Lightweight, semi-rimless design offers extended eye coverage and all day comfort
- :: Bayonet style temples with non-slip rubber pads for a secure fit
- :: Adjustable rubber nose pads offer a custom fit
- :: Anti-fog coating is standard on most models
- :: 9.5 base curve

LENS TECHNOLOGY



MEETS ANSI **Z87.1+** INDICATES
MEETS CSA **Z94.3**

| STYLE NUMBER | LENS | COATING | FRAME |
|-----------------------------|--|-------------------------|--------|
| 250-33-0020 | Clear | Anti-Scratch / Anti-Fog | Black |
| 250-33-0021 | Gray | Anti-Scratch / Anti-Fog | Black |
| 250-33-0010 | Clear Anti-Reflective Plus™ Technology | Anti-Scratch | Black |
| 250-33-0226 | 1/0 Blue Technology | Anti-Scratch / Anti-Fog | Black |
| 250-33-0041 | Gray Polarized XL5™ Technology | Anti-Scratch | Black |
| 250-33-1020 | Clear | Anti-Scratch / Anti-Fog | Bronze |
| 250-33-1024 | Gray | Anti-Scratch / Anti-Fog | Bronze |
| 250-33-1010 | Clear Anti-Reflective Plus™ Technology | Anti-Scratch | Bronze |
| 250-33-1226 | 1/0 Blue | Anti-Scratch / Anti-Fog | Bronze |
| 250-33-1042 | Brown Polarized XL5™ Technology | Anti-Scratch | Bronze |

bouton
OPTICAL



COMMAND ATTENTION



FIRST IN STYLING

bouton
OPTICAL





ANSER™

MEETS ANSI
Z87.1+  INDICATES
MEETS CSA
Z94.3

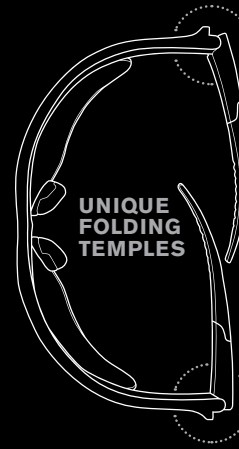
- :: Lightweight, semi-rimless design provides all day user comfort
- :: Sleek, sporty style with wraparound lens protection
- :: Bayonet temples with flexible rubber tips offer a comfortable, secure fit
- :: Soft rubber nose pads help keep the glasses in place
- :: Unique folding temples prevent arms from folding into and scratching the lenses
- :: 9 base curve



| STYLE NUMBER | LENS | COATING | FRAME |
|------------------------------|-----------------|-------------------------|---|
| 250-AN-10110 | ■ Clear | Anti-Scratch | □ Black |
| 250-AN-10111 | ■ Clear | Anti-Scratch / Anti-Fog | □ Black  |
| 250-AN-10112 | ■ Gray | Anti-Scratch | □ Black |
| 250-AN-10113 | ■ Light Blue | Anti-Scratch | □ Black |
| 250-AN-10114 | ■ I/O | Anti-Scratch | □ Black  |
| 250-AN-10115 | ■ Blue Mirror | Anti-Scratch | □ Black |
| 250-AN-10116 | ■ Red Mirror | Anti-Scratch | □ Black |
| 250-AN-10118 | ■ IR Filter 3.0 | Anti-Scratch | □ Black |
| 250-AN-10119 | ■ IR Filter 5.0 | Anti-Scratch | □ Black |
| 250-AN-10120 | ■ Amber | Anti-Scratch | □ Black |
| 250-AN-10125 | ■ Silver Mirror | Anti-Scratch | □ Black |
| 250-AN-10126 | ■ Gray | Anti-Scratch / Anti-Fog | □ Black  |
| 250-AN-10117 | ■ Gray | Anti-Scratch | ■ Red |
| 250-AN-10121 | ■ Brown | Anti-Scratch | ■ Camouflage |
| 250-AN-10122 | ■ Amber | Anti-Scratch | ■ Camouflage |
| 250-AN-10123 | ■ Gray | Anti-Scratch | ■ Camouflage |
| 250-AN-10124 | ■ Brown | Anti-Scratch / Anti-Fog | ■ Camouflage |
| 250-AN-10127 | ■ Amber | Anti-Scratch / Anti-Fog | ■ Camouflage |
| 250-AN-10128 | ■ Silver Mirror | Anti-Scratch | ■ Camouflage |
| 250-AN-10130 | ■ Clear | Anti-Scratch | ■ Camouflage |
| 250-AN-10131 | ■ Clear | Anti-Scratch / Anti-Fog | ■ Camouflage |



..... CAMO FRAME AVAILABLE



ATHLETIC DESIGN



Q-VISION™

- :: Rimless design offers improved field of vision and comfort
- :: Co-injected rubber temple ends provide excellent temple grip
- :: Flexible nose bridge for a comfortable fit
- :: Dielectric, non-conductive frame
- :: Anti-fog coating is standard on most models
- :: 9.75 base curve

LENS TECHNOLOGY



MEETS ANSI
Z87.1+



| STYLE NUMBER | LENS | COATING | FRAME |
|--------------------|--|-------------------------|------------|
| 250-36-0020 | ■ Clear | Anti-Scratch / Anti-Fog | ■ Burgundy |
| 250-36-0021 | ■ Gray | Anti-Scratch / Anti-Fog | ■ Burgundy |
| 250-36-0010 | ■ Clear Anti-Reflective Plus™ Technology | Anti-Scratch | ■ Burgundy |
| 250-36-0025 | ■ Silver Mirror | Anti-Scratch / Anti-Fog | ■ Burgundy |
| 250-36-0226 | ■ I/O Blue Technology | Anti-Scratch / Anti-Fog | ■ Burgundy |
| 250-36-1020 | ■ Clear | Anti-Scratch / Anti-Fog | ■ Lime |
| 250-36-1021 | ■ Gray | Anti-Scratch / Anti-Fog | ■ Lime |
| 250-36-1010 | ■ Clear Anti-Reflective Plus™ Technology | Anti-Scratch | ■ Lime |
| 250-36-1226 | ■ I/O Blue Technology | Anti-Scratch / Anti-Fog | ■ Lime |



RADAR™

MEETS ANSI
Z87.1+

- :: Lightweight, rimless design offers optimal protection
- :: Bayonet temples are rubber co-molded for a comfortable fit
- :: Non-slip rubber nose pads provide a secure fit
- :: Anti-fog coating is standard on most models
- :: 10 base curve

LENS TECHNOLOGY



| STYLE NUMBER | LENS | COATING | FRAME |
|-----------------------------|--|-------------------------|--------|
| 250-45-0020 | ■ Clear | Anti-Scratch / Anti-Fog | ■ Gray |
| 250-45-0021 | ■ Gray | Anti-Scratch / Anti-Fog | ■ Gray |
| 250-45-0010 | ■ Clear Anti-Reflective Plus™ Technology | Anti-Scratch | ■ Gray |
| 250-45-0226 | ■ I/O Blue Technology | Anti-Scratch / Anti-Fog | ■ Gray |
| 250-45-1020 | ■ Clear | Anti-Scratch / Anti-Fog | ■ Red |
| 250-45-1021 | ■ Gray | Anti-Scratch / Anti-Fog | ■ Red |
| 250-45-1010 | ■ Clear Anti-Reflective Plus™ Technology | Anti-Scratch | ■ Red |
| 250-45-1226 | ■ I/O Blue Technology | Anti-Scratch / Anti-Fog | ■ Red |

LOCKED IN LOCKED ON

bouton
OPTICAL

RUGGED & RAW

RECON™

MEETS ANSI Z87.1+  INDICATES MEETS CSA Z94.3





- :: Lightweight, rimless design for ergonomic fit
- :: Flexible bayonet temples contain rubber pads for a secure, non-slip fit
- :: Adjustable rubber nosepiece provides a comfortable fit
- :: Anti-fog coating is standard on most models
- :: 9 base curve

LENS TECHNOLOGY

 ANTI-REFLECTIVE PLUS™ TECHNOLOGY

 I/O BLUE TECHNOLOGY

 FOGLESS® 3SIXTY™ TECHNOLOGY

| STYLE NUMBER | LENS | COATING | FRAME |
|-----------------------------|--|---------------------------------|---|
| 250-32-0020 | ■ Clear | Anti-Scratch / Anti-Fog | ■ Clear  |
| 250-32-0021 | ■ Gray | Anti-Scratch / Anti-Fog | □ Black  |
| 250-32-0010 | ■ Clear Anti-Reflective Plus™ Technology | Anti-Scratch | ■ Clear  |
| 250-32-0226 | ■ I/O | Anti-Scratch / Anti-Fog | ■ Brown  |
| 250-32-0031 | ■ Gradient | Anti-Scratch / Anti-Fog | □ Black  |
| 250-32-0520 | ■ Clear | Anti-Scratch / FogLess® 3Sixty™ | ■ Clear |
| 250-32-0521 | ■ Gray | Anti-Scratch / FogLess® 3Sixty™ | ■ Gray |



bouton
OPTICAL

CAPTAIN™

MEETS ANSI
Z87.1+

- :: Lightweight, rimless design provides all day user comfort
- :: Bayonet temples with end tips that curve out for ease of placement on face
- :: Non-slip rubber nose pads offer a secure fit
- :: Anti-fog coating is standard on most models
- :: 10 base curve

LENS TECHNOLOGY



| STYLE NUMBER | LENS | COATING | FRAME |
|-----------------------------|--|---------------------------------|---------|
| 250-46-0020 | ■ Clear | Anti-Scratch / Anti-Fog | ■ Clear |
| 250-46-0021 | ■ Gray | Anti-Scratch / Anti-Fog | ■ Gray |
| 250-46-0010 | ■ Clear Anti-Reflective Plus™ Technology | Anti-Scratch | ■ Clear |
| 250-46-0226 | ■ I/O Blue Technology | Anti-Scratch / Anti-Fog | ■ Brown |
| 250-46-0520 | ■ Clear | Anti-Scratch / FogLess® 3Sixty™ | ■ Clear |
| 250-46-0521 | ■ Gray | Anti-Scratch / FogLess® 3Sixty™ | ■ Gray |

TAKE THE LEAD





BOUTON[®] LENS TREATMENT QUICK GUIDE

| LENS TREATMENT/COLOR | VISIBLE LIGHT TRANSMISSION | DESCRIPTION | BENEFITS |
|------------------------------|----------------------------|---|--|
| ANTI-SCRATCH | --- | "Hardcoat" treatment toughens lens surface | Longer product life with fewer scratches. |
| ANTI-FOG | --- | Surface coating that reduces fogging | Maintains clear vision. Ideal for food plants or cleaning operations with high-humidity environments. |
| ■ CLEAR | 90% | Clear polycarbonate lens | No color distortion, all polycarbonate has 99.9% UV absorption. General use. |
| ■ AMBER | 82% | Polycarbonate made of bright amber/yellow color | Enhances visual acuity. Ideal for professional drivers in foggy, rainy or snowy conditions. |
| ■ INDOOR/OUTDOOR | 60% | Light mirror coating on clear lens | Enough light transmission for use indoors, reduces pupil adjustment time. Ideal for indoor-outdoor workers. |
| ■ INDOOR/OUTDOOR BLUE | 55% | Slight yellow tint + light mirror coating | Alleviates "digital eye strain" from screens, ideal for anyone working extended periods with computer screens or electronic devices. |
| ■ LIGHT BLUE | 58% | Light blue tinted polycarbonate | Relieves eye strain from bright, overhead fluorescent lighting. |
| ■ GRAY | 12% | Gray polycarbonate lens | Darkening effect with little color distortion, best used outdoors in bright sun. |
| ■ DARK BROWN | 12% | Brown polycarbonate lens | Darkening effect with improved color contrast. Best used outdoors in nature-green colors enhanced. |
| ■ MIRROR | 10-18% | Front surface coating reflects light from lens | Less light transmission for a darkening effect, great in bright environments: snow, sand, rocks, water. |
| ■ IR FILTER SHADE 3.0 | 10% | Dark green polycarbonate lens | Protection from welding arc and IR light. Not to be used for welding or when operating vehicles. |
| ■ IR FILTER SHADE 5.0 | 2% | Dark green polycarbonate lens | Protection from welding arc and IR light. Not to be used for welding or when operating vehicles. |

bouton
OPTICAL

SAFETY EYEWEAR DESIGN EVOLUTION



1950 - 1960's



1970 - 1980's



1990 - 2000's



TODAY



LIGHTWEIGHT

Weighing only 16 grams, it is among the lightest in the market today



ENHANCED PROTECTION

Enhanced lens design extends field of vision and protection



MODERN STYLE

Squared lens shape with a slight taper, provides modern styling for the wearer



SECURE FIT

Sleek temples with strategically perforated design ensures a flexible, secure fit to multiple head shapes and sizes

bouton
OPTICAL

ZENON Z-LYTE EVOLVED EYE PROTECTION

ZENON Z-LYTE





| KEY FEATURE | Lightweight – Only 16 grams | | |
|--------------------|-----------------------------|-------------------------|---------|
| FIT | Universal | | |
| BRIDGE | Molded | | |
| TEMPLE | Spatula | | |
| BASE CURVE | 9.5 | | |
| STANDARDS MET | ANSI Z87.1+ | | |
| STYLE NUMBER | LENS | COATING | FRAME |
| 250-09-0000 | ■ Clear | Anti-Scratch | ■ Clear |
| 250-09-0001 | □ Gray | Anti-Scratch | □ Gray |
| 250-09-0002 | ■ I/O | Anti-Scratch | ■ Clear |
| 250-09-0020 | ■ Clear | Anti-Scratch / Anti-Fog | ■ Clear |
| 250-09-0021 | □ Gray | Anti-Scratch / Anti-Fog | □ Gray |

NEVER-ENDING INNOVATION
WEIGHS ONLY
16 GRAMS



FOAM LINED STYLES
AVAILABLE
Go to page 205

ZENON Z12

| | | | |
|-----------------------------|--|---|--|
| KEY FEATURE | Popular Style - Fits Most Workers and Applications | | |
| FIT | Universal | | |
| BRIDGE | Molded | | |
| TEMPLE | Spatula | | |
| BASE CURVE | 9.5 | | |
| STANDARDS MET | ANSI Z87.1+ | CSA Z94.3 - <i>Styles Indicated Below</i>  | |
| STYLE NUMBER | LENS | COATING | FRAME |
| 250-01-0000 | <input type="checkbox"/> Clear | Anti-Scratch | <input type="checkbox"/> Black |
| 250-01-0001 | <input type="checkbox"/> Gray | Anti-Scratch | <input type="checkbox"/> Black |
| 250-01-0002 | <input type="checkbox"/> I/O | Anti-Scratch | <input type="checkbox"/> Black |
| 250-01-0004 | <input type="checkbox"/> Orange | Anti-Scratch | <input type="checkbox"/> Black |
| 250-01-0005 | <input type="checkbox"/> Silver Mirror | Anti-Scratch | <input type="checkbox"/> Black |
| 250-01-0020 | <input type="checkbox"/> Clear | Anti-Scratch / Anti-Fog | <input type="checkbox"/> Black |
| 250-01-0021 | <input type="checkbox"/> Gray | Anti-Scratch / Anti-Fog | <input type="checkbox"/> Black  |
| 250-01-0080 | <input type="checkbox"/> Clear | Uncoated | <input type="checkbox"/> Black |
| 250-01-5503 | <input type="checkbox"/> Light Blue | Anti-Scratch | <input type="checkbox"/> Light Blue |
| 250-01-5504 | <input type="checkbox"/> Dark Brown | Anti-Scratch | <input type="checkbox"/> Dark Brown |
| 250-01-5509 | <input type="checkbox"/> Amber | Anti-Scratch | <input type="checkbox"/> Amber |
| 250-01-0900 | <input type="checkbox"/> Clear | Anti-Scratch | <input type="checkbox"/> Clear  |
| 250-01-0902 | <input type="checkbox"/> I/O | Anti-Scratch | <input type="checkbox"/> Clear |
| 250-01-0920 | <input type="checkbox"/> Clear | Anti-Scratch / Anti-Fog | <input type="checkbox"/> Clear  |
| 250-01-0980 | <input type="checkbox"/> Clear | Uncoated | <input type="checkbox"/> Clear |



bouton
OPTICAL

ZENON SERIES
#1 VALUE
FOR SAFETY
& COMFORT



NARROW
FIT



RUBBER
TEMPLE TIPS



RUBBER
NOSE BRIDGE

RUBBER
TEMPLE TIPS

ZENON Z11SM

| | | | |
|-----------------------------|-----------------------------------|---|-----------|
| KEY FEATURE | Redesigned Z12 for Narrower Faces | | |
| FIT | Narrow | | |
| BRIDGE | Molded | | |
| TEMPLE | Spatula | | |
| BASE CURVE | 10 | | |
| STANDARDS MET | ANSI Z87.1+ | CSA Z94.3 - <i>Styles Indicated Below</i> 🍁 | |
| STYLE NUMBER | LENS | COATING | FRAME |
| 250-00-0000 | ■ Clear | Anti-Scratch | □ Black |
| 250-00-0020 | ■ Clear | Anti-Scratch / Anti-Fog | ■ Clear |
| 250-00-0001 | ■ Gray | Anti-Scratch | □ Black 🍁 |
| 250-00-0002 | ■ I/O | Anti-Scratch | □ Black |
| 250-00-0900 | ■ Clear | Anti-Scratch | ■ Clear 🍁 |
| 250-00-0920 | ■ Clear | Anti-Scratch / Anti-Fog | □ Black |

ZENON Z13

| | | | |
|-----------------------------|-------------------------|---|---------------|
| KEY FEATURE | Flexible Rubber Temples | | |
| FIT | Universal | | |
| BRIDGE | Molded | | |
| TEMPLE | Rubber Tips | | |
| BASE CURVE | 10 | | |
| STANDARDS MET | ANSI Z87.1+ | CSA Z94.3 - <i>Styles Indicated Below</i> 🍁 | |
| STYLE NUMBER | LENS | COATING | FRAME |
| 250-06-0000 | ■ Clear | Anti-Scratch | ■ Clear |
| 250-06-0002 | ■ I/O | Anti-Scratch | ■ Brown 🍁 |
| 250-06-0020 | ■ Clear | Anti-Scratch / Anti-Fog | ■ Clear 🍁 |
| 250-06-0080 | ■ Clear | Uncoated | ■ Clear |
| 250-06-0005 | ■ Silver Mirror | Anti-Scratch | □ Black |
| 250-06-0006 | ■ Blue Mirror | Anti-Scratch | □ Black |
| 250-06-5501 | ■ Gray | Anti-Scratch | □ Dark Gray |
| 250-06-5521 | ■ Gray | Anti-Scratch / Anti-Fog | □ Dark Gray 🍁 |
| 250-06-5503 | ■ Light Blue | Anti-Scratch | ■ Light Blue |
| 250-06-5504 | ■ Dark Brown | Anti-Scratch | ■ Dark Brown |
| 250-06-5509 | ■ Amber | Anti-Scratch | ■ Amber |

ZENON Z14SN

| | | | |
|-----------------------------|--|---|--------------|
| KEY FEATURE | Flexible Rubber Temples & Comfortable Rubber Nose Bridge | | |
| FIT | Universal | | |
| BRIDGE | Rubber | | |
| TEMPLE | Rubber Tips | | |
| BASE CURVE | 10 | | |
| STANDARDS MET | ANSI Z87.1+ | CSA Z94.3 - <i>Styles Indicated Below</i> 🍁 | |
| STYLE NUMBER | LENS | COATING | FRAME |
| 250-08-0000 | ■ Clear | Anti-Scratch | ■ Clear |
| 250-08-0002 | ■ I/O | Anti-Scratch | ■ Clear |
| 250-08-0020 | ■ Clear | Anti-Scratch / Anti-Fog | ■ Clear 🍁 |
| 250-08-0001 | ■ Gray | Anti-Scratch | □ Black |
| 250-08-0005 | ■ Silver Mirror | Anti-Scratch | □ Black |
| 250-08-0021 | ■ Gray | Anti-Scratch / Anti-Fog | □ Black 🍁 |
| 250-08-5503 | ■ Light Blue | Anti-Scratch | ■ Light Blue |
| 250-08-5509 | ■ Amber | Anti-Scratch / Anti-Fog | ■ Amber |

LIGHTWEIGHT & UNOBSTRUCTED PERIPHERAL VISION



EVA®

| | | | |
|------------------------------------|--|-------------------------|--|
| KEY FEATURE | Safety Eyewear Designed Specifically for Women | | |
| FIT | Women | | |
| BRIDGE | Molded | | |
| TEMPLE | Rubber Tips | | |
| BASE CURVE | 10 | | |
| STANDARDS MET | ANSI Z87.1+ | | |
| STYLE NUMBER | LENS | COATING | FRAME |
| <u>250-10-0900</u> | <input type="checkbox"/> Clear | Anti-Scratch | <input checked="" type="checkbox"/> Clear / Pink |
| <u>250-10-0920</u> | <input type="checkbox"/> Clear | Anti-Scratch / Anti-Fog | <input checked="" type="checkbox"/> Clear / Pink |
| <u>250-10-0904</u> | <input checked="" type="checkbox"/> Pink | Anti-Scratch | <input checked="" type="checkbox"/> Clear / Pink |
| <u>250-10-5501</u> | <input checked="" type="checkbox"/> Gray | Anti-Scratch | <input checked="" type="checkbox"/> Gray / Pink |

EVA® PETITE

| | | | |
|------------------------------------|--|-------------------------|--|
| KEY FEATURE | Women's Style Designed for Slender Faces | | |
| FIT | Women | | |
| BRIDGE | Molded | | |
| TEMPLE | Rubber Tips | | |
| BASE CURVE | 11 | | |
| STANDARDS MET | ANSI Z87.1+ | | |
| STYLE NUMBER | LENS | COATING | FRAME |
| <u>250-11-0900</u> | <input type="checkbox"/> Clear | Anti-Scratch | <input checked="" type="checkbox"/> Clear / Pink |
| <u>250-11-0920</u> | <input type="checkbox"/> Clear | Anti-Scratch / Anti-Fog | <input checked="" type="checkbox"/> Clear / Pink |
| <u>250-11-0904</u> | <input checked="" type="checkbox"/> Pink | Anti-Scratch | <input checked="" type="checkbox"/> Clear / Pink |
| <u>250-11-5501</u> | <input checked="" type="checkbox"/> Gray | Anti-Scratch | <input checked="" type="checkbox"/> Gray / Pink |

LADY EVA® READER

| | | | | |
|------------------------------------|-------------------------------------|--------------|--|----------|
| KEY FEATURE | Safety Readers Engineered for Women | | | |
| FIT | Women | | | |
| BRIDGE | Molded | | | |
| TEMPLE | Rubber Tips | | | |
| BASE CURVE | 10 | | | |
| STANDARDS MET | ANSI Z87.1+ | | | |
| STYLE NUMBER | LENS | COATING | FRAME | DIOPTRER |
| <u>250-12-0100</u> | <input type="checkbox"/> Clear | Anti-Scratch | <input checked="" type="checkbox"/> Clear / Pink | 1.00 |
| <u>250-12-0125</u> | <input type="checkbox"/> Clear | Anti-Scratch | <input checked="" type="checkbox"/> Clear / Pink | 1.25 |
| <u>250-12-0150</u> | <input type="checkbox"/> Clear | Anti-Scratch | <input checked="" type="checkbox"/> Clear / Pink | 1.50 |
| <u>250-12-0175</u> | <input type="checkbox"/> Clear | Anti-Scratch | <input checked="" type="checkbox"/> Clear / Pink | 1.75 |
| <u>250-12-0200</u> | <input type="checkbox"/> Clear | Anti-Scratch | <input checked="" type="checkbox"/> Clear / Pink | 2.00 |
| <u>250-12-0225</u> | <input type="checkbox"/> Clear | Anti-Scratch | <input checked="" type="checkbox"/> Clear / Pink | 2.25 |
| <u>250-12-0250</u> | <input type="checkbox"/> Clear | Anti-Scratch | <input checked="" type="checkbox"/> Clear / Pink | 2.50 |
| <u>250-12-0275</u> | <input type="checkbox"/> Clear | Anti-Scratch | <input checked="" type="checkbox"/> Clear / Pink | 2.75 |
| <u>250-12-0300</u> | <input type="checkbox"/> Clear | Anti-Scratch | <input checked="" type="checkbox"/> Clear / Pink | 3.00 |

EVA® SERIES DESIGNED TO FIT



A PORTION OF ALL PROCEEDS FROM OUR EVA® EYEWEAR IS PROUDLY DONATED TO ORGANIZATIONS WITH A MISSION OF COMBATING CANCER.

Breast cancer has impacted everyone in one way or another and Eva® eyewear provides a great venue to promote awareness. Perhaps one more woman in the workplace will get a mammogram because she sees the pink ribbons on all of her co-workers' glasses. Please help PIP support this wonderful cause as we provide a VISION FOR A CAUSE!



WOMEN

bouton
OPTICAL



bouton
OPTICAL

RIMLESS FRAME



WILCO

| KEY FEATURE | Panoramic View with Adjustable Length Temples | | |
|--------------------|---|-------------------------|---------|
| FIT | Universal | | |
| BRIDGE | Rubber | | |
| TEMPLE | Adjustable Spatula | | |
| BASE CURVE | 8 | | |
| STANDARDS MET | ANSI Z87.1+ | | |
| STYLE NUMBER | LENS | COATING | FRAME |
| <u>250-92-0000</u> | <input type="checkbox"/> Clear | Anti-Scratch | ■ Black |
| <u>250-92-0001</u> | <input type="checkbox"/> Gray | Anti-Scratch | ■ Black |
| <u>250-92-0002</u> | <input type="checkbox"/> I/O | Anti-Scratch | ■ Black |
| <u>250-92-0005</u> | <input type="checkbox"/> Silver Mirror | Anti-Scratch | ■ Black |
| <u>250-92-0009</u> | <input type="checkbox"/> Amber | Anti-Scratch | ■ Black |
| <u>250-92-0020</u> | <input type="checkbox"/> Clear | Anti-Scratch / Anti-Fog | ■ Black |
| <u>250-92-0021</u> | <input type="checkbox"/> Gray | Anti-Scratch / Anti-Fog | ■ Black |

SUPERIOR SAFETY,



RUBBER
NOSE BRIDGE



RUBBER
NOSE BRIDGE



« UNIQUE TEMPLE »
DESIGN

PULSE

| | | | |
|---------------------------|---|-------------------------|--|
| KEY FEATURE | Style and User Comfort in a Lightweight Design | | |
| FIT | Universal | | |
| BRIDGE | Rubber | | |
| TEMPLE | Bayonet, Rubber Tips | | |
| BASE CURVE | 9.75 | | |
| STANDARDS MET | ANSI Z87.1+ CSA Z94.3 - <i>Styles Indicated Below</i> 🍁 | | |
| STYLE NUMBER | LENS | COATING | FRAME |
| <u>250-49-0000</u> | <input type="checkbox"/> Clear | Anti-Scratch | <input type="checkbox"/> Clear |
| <u>250-49-0020</u> | <input type="checkbox"/> Clear | Anti-Scratch / Anti-Fog | <input type="checkbox"/> Clear 🍁 |
| <u>250-49-0021</u> | <input checked="" type="checkbox"/> Gray | Anti-Scratch / Anti-Fog | <input checked="" type="checkbox"/> Gray 🍁 |
| <u>250-49-0022</u> | <input checked="" type="checkbox"/> I/O | Anti-Scratch / Anti-Fog | <input type="checkbox"/> Brown 🍁 |

MONTERAY II

| | | | |
|----------------------------|---|-------------------------|---|
| KEY FEATURE | Modern Squared Lens Design with Rubber Temples and Bridge | | |
| FIT | Universal | | |
| BRIDGE | Rubber | | |
| TEMPLE | Rubber Tips | | |
| BASE CURVE | 9.75 | | |
| STANDARDS MET | ANSI Z87.1+ | | |
| STYLE NUMBER | LENS | COATING | FRAME |
| <u>250-MT-10070</u> | <input type="checkbox"/> Clear | Anti-Scratch | <input checked="" type="checkbox"/> Black |
| <u>250-MT-10071</u> | <input type="checkbox"/> Clear | Anti-Scratch / Anti-Fog | <input checked="" type="checkbox"/> Black |
| <u>250-MT-10072</u> | <input checked="" type="checkbox"/> Gray | Anti-Scratch | <input checked="" type="checkbox"/> Black |
| <u>250-MT-10074</u> | <input checked="" type="checkbox"/> Amber | Anti-Scratch | <input checked="" type="checkbox"/> Black |
| <u>250-MT-10075</u> | <input type="checkbox"/> I/O | Anti-Scratch | <input checked="" type="checkbox"/> Black |

TRANZMISSION

| | | | |
|---------------------------|--|-------------------------|---|
| KEY FEATURE | Wraparound Style and Special Temple Design for Comfort | | |
| FIT | Universal | | |
| BRIDGE | Rubber | | |
| TEMPLE | Rubber Tips | | |
| BASE CURVE | 10 | | |
| STANDARDS MET | ANSI Z87.1+ | | |
| STYLE NUMBER | LENS | COATING | FRAME |
| <u>250-71-0000</u> | <input type="checkbox"/> Clear | Anti-Scratch | <input checked="" type="checkbox"/> Black |
| <u>250-71-0002</u> | <input checked="" type="checkbox"/> I/O | Anti-Scratch | <input checked="" type="checkbox"/> Black |
| <u>250-71-0020</u> | <input type="checkbox"/> Clear | Anti-Scratch / Anti-Fog | <input checked="" type="checkbox"/> Black |
| <u>250-71-0001</u> | <input checked="" type="checkbox"/> Gray | Anti-Scratch | <input checked="" type="checkbox"/> Black |
| <u>250-71-0005</u> | <input type="checkbox"/> Silver Mirror | Anti-Scratch | <input checked="" type="checkbox"/> Black |
| <u>250-71-0021</u> | <input checked="" type="checkbox"/> Gray | Anti-Scratch / Anti-Fog | <input checked="" type="checkbox"/> Black |

COMFORT & ENHANCED FEATURES



bouton
OPTICAL

RIMLESS FRAME ULTIMATE IN COMFORT & STYLE



BULLSEYE

| | | | |
|--------------------|--|---|--|
| KEY FEATURE | Modern Design Available in a Variety of Lenses | | |
| FIT | Round | | |
| BRIDGE | Molded | | |
| TEMPLE | Bayonet, Rubber Tips | | |
| BASE CURVE | 9 | | |
| STANDARDS MET | ANSI Z87.1+ | CSA Z94.3 - <i>Styles Indicated Below</i> | 🍁 |
| STYLE NUMBER | LENS | COATING | FRAME |
| 250-31-0020 | <input type="checkbox"/> Clear | Anti-Scratch / Anti-Fog | <input type="checkbox"/> Clear 🍁 |
| 250-31-0021 | <input checked="" type="checkbox"/> Gray | Anti-Scratch / Anti-Fog | <input checked="" type="checkbox"/> Gray 🍁 |
| 250-31-0023 | <input checked="" type="checkbox"/> Light Blue | Anti-Scratch / Anti-Fog | <input checked="" type="checkbox"/> Light Blue |
| 250-31-0029 | <input checked="" type="checkbox"/> Amber | Anti-Scratch / Anti-Fog | <input checked="" type="checkbox"/> Amber |
| 250-31-0010 | <input type="checkbox"/> Clear Anti-Reflective PLUS™ | Anti-Scratch | <input type="checkbox"/> Clear |
| 250-31-0026 | <input checked="" type="checkbox"/> Blue Mirror | Anti-Scratch / Anti-Fog | <input checked="" type="checkbox"/> Gray 🍁 |
| 250-31-0226 | <input checked="" type="checkbox"/> I/O Blue | Anti-Scratch / Anti-Fog | <input type="checkbox"/> Brown |
| 250-31-0031 | <input type="checkbox"/> Gradient | Anti-Scratch / Anti-Fog | <input type="checkbox"/> Clear |



SUPERSONIC CONVERTS TO A DUST GOGGLE

CONVERSION KIT SOLD SEPARATELY



FULLY ADJUSTABLE FRAME DESIGN
MORPHS FROM
GLASSES TO DUST GOGGLES



SUPERSONIC

| KEY FEATURE | Fully Adjustable Temples, and an Optional Dust Goggle Kit | | |
|---------------------------|---|-------------------------|---------|
| FIT | Universal | | |
| BRIDGE | Rubber | | |
| TEMPLE | Fully Adjustable, Rubber Tips | | |
| BASE CURVE | 9 | | |
| STANDARDS MET | ANSI Z87.1+ | | |
| STYLE NUMBER | LENS | COATING | FRAME |
| <u>250-34-0020</u> | <input type="checkbox"/> Clear | Anti-Scratch / Anti-Fog | ■ Black |
| <u>250-34-0021</u> | <input type="checkbox"/> Gray | Anti-Scratch / Anti-Fog | ■ Black |
| <u>250-34-0010</u> | <input type="checkbox"/> Clear Anti-Reflective PLUS™ | Anti-Scratch | ■ Black |
| <u>250-34-0226</u> | <input type="checkbox"/> I/O Blue | Anti-Scratch / Anti-Fog | ■ Black |
| <u>250-34-0031</u> | <input type="checkbox"/> Gradient | Anti-Scratch / Anti-Fog | ■ Black |
| <u>250-34-FOAM</u> | --- | Foam/Strap Kit | ■ Black |



HI-VOLTAGE ARC

| | | | |
|---------------|--|--|--|
| KEY FEATURE | Economic Eye Protection with Adjustable Length Temples | | |
| FIT | Universal | | |
| BRIDGE | Molded | | |
| TEMPLE | Spatula | | |
| BASE CURVE | 4 | | |
| STANDARDS MET | ANSI Z87.1+ | | |

| STYLE NUMBER | LENS | COATING | FRAME |
|-----------------------------|---------|--------------|------------------|
| 250-24-0000 | ■ Clear | Anti-Scratch | □ Black |
| 250-24-0001 | ■ Gray | Anti-Scratch | □ Black |
| 250-24-0080 | ■ Clear | Uncoated | □ Black |
| 250-24-0300 | ■ Clear | Anti-Scratch | ■ Red White Blue |
| 250-24-0301 | ■ Gray | Anti-Scratch | ■ Red White Blue |

HI-VOLTAGE AC

| | | | |
|---------------|---|--|--|
| KEY FEATURE | Contemporary Styling with Bayonet Temples for Excellent Fit | | |
| FIT | Narrow | | |
| BRIDGE | Rubber | | |
| TEMPLE | Bayonet, Rubber Tips | | |
| BASE CURVE | 10 | | |
| STANDARDS MET | ANSI Z87.1+ | | |

| STYLE NUMBER | LENS | COATING | FRAME |
|-----------------------------|--------------|-------------------------|---------|
| 250-21-0100 | ■ Clear | Anti-Scratch | ■ Blue |
| 250-21-0101 | ■ Gray | Anti-Scratch | ■ Blue |
| 250-21-0102 | ■ I/O | Anti-Scratch | ■ Blue |
| 250-21-0120 | ■ Clear | Anti-Scratch / Anti-Fog | ■ Blue |
| 250-21-0400 | ■ Clear | Anti-Scratch | □ Black |
| 250-21-0401 | ■ Gray | Anti-Scratch | □ Black |
| 250-21-0402 | ■ I/O | Anti-Scratch | □ Black |
| 250-21-0403 | ■ Light Blue | Anti-Scratch | □ Black |
| 250-21-0409 | ■ Amber | Anti-Scratch | □ Black |
| 250-21-0420 | ■ Clear | Anti-Scratch / Anti-Fog | □ Black |
| 250-21-0421 | ■ Gray | Anti-Scratch / Anti-Fog | □ Black |

BLIZZARD

| | | | |
|---------------|---|--|--|
| KEY FEATURE | Sporty White Frame Stands Out When Working Outdoors | | |
| FIT | Universal | | |
| BRIDGE | Rubber | | |
| TEMPLE | Bayonet, Rubber Tips | | |
| BASE CURVE | 8 | | |
| STANDARDS MET | ANSI Z87.1+ | | |

| STYLE NUMBER | LENS | COATING | FRAME |
|-----------------------------|---------------|-------------------------|---------|
| 250-48-0021 | ■ Gray | Anti-Scratch / Anti-Fog | ■ White |
| 250-48-0006 | ■ Blue Mirror | Anti-Scratch | ■ White |
| 250-48-0226 | ■ I/O Blue | Anti-Scratch / Anti-Fog | ■ White |

bouton
OPTICAL

SEMI-RIMLESS FRAME



RUBBER NOSE BRIDGE

ADVERSARY

| KEY FEATURE | Popular Wraparound Design Fits a Variety of Users | | |
|-----------------------------|---|-------------------------|--------------------------------|
| FIT | Round | | |
| BRIDGE | Rubber | | |
| TEMPLE | Bayonet, Rubber Tips | | |
| BASE CURVE | 8 | | |
| STANDARDS MET | ANSI Z87.1+ | | |
| STYLE NUMBER | LENS | COATING | FRAME |
| 250-28-0000 | ■ Clear | Anti-Scratch | <input type="checkbox"/> Black |
| 250-28-0001 | ■ Gray | Anti-Scratch | <input type="checkbox"/> Black |
| 250-28-0002 | ■ I/O | Anti-Scratch | <input type="checkbox"/> Black |
| 250-28-0003 | ■ Light Blue | Anti-Scratch | <input type="checkbox"/> Black |
| 250-28-0006 | ■ Silver Mirror | Anti-Scratch | <input type="checkbox"/> Black |
| 250-28-0009 | ■ Amber | Anti-Scratch | <input type="checkbox"/> Black |
| 250-28-0020 | ■ Clear | Anti-Scratch / Anti-Fog | <input type="checkbox"/> Black |
| 250-28-0021 | ■ Gray | Anti-Scratch / Anti-Fog | <input type="checkbox"/> Black |

WRAPAROUND LENS



bouton
OPTICAL

FULL
FRAME
STYLE



SIDE SHIELD
PROTECTION

TRADITIONAL SPECTACLE

| KEY FEATURE | Classic Styling in a Durable Propionate Frame | | |
|----------------------------|---|-------------------------|---|
| FIT | Universal | | |
| BRIDGE | Molded | | |
| TEMPLE | Spatula | | |
| BASE CURVE | 6 | | |
| STANDARDS MET | ANSI Z87.1+ | | |
| STYLE NUMBER | LENS | COATING | FRAME |
| <u>249-5907-400</u> | <input type="checkbox"/> Clear | Anti-Scratch / Anti-Fog | <input checked="" type="checkbox"/> Smoke |
| <u>249-5907-401</u> | <input checked="" type="checkbox"/> Gray | Anti-Scratch / Anti-Fog | <input checked="" type="checkbox"/> Smoke |
| <u>249-5907-207</u> | <input checked="" type="checkbox"/> IR Filter 3.0 | Anti-Scratch / Anti-Fog | <input checked="" type="checkbox"/> Smoke |

STYLISH DESIGN &



FLASHFIRE

| KEY FEATURE | Padded Upper Brow Provides Additional Comfort | | |
|--------------------|--|-------------------------|--|
| FIT | Universal | | |
| BRIDGE | Rubber | | |
| TEMPLE | Rubber Tips | | |
| BASE CURVE | 8 | | |
| STANDARDS MET | ANSI Z87.1+ | | |
| STYLE NUMBER | LENS | COATING | FRAME |
| 250-60-0620 | <input type="checkbox"/> Clear | Anti-Scratch / Anti-Fog | <input checked="" type="checkbox"/> Silver / Blue |
| 250-60-0020 | <input type="checkbox"/> Clear | Anti-Scratch / Anti-Fog | <input checked="" type="checkbox"/> Black / Red |
| 250-60-0630 | <input checked="" type="checkbox"/> Green Mirror | Anti-Scratch / Anti-Fog | <input checked="" type="checkbox"/> Silver / Green |
| 250-60-0625 | <input checked="" type="checkbox"/> Red Mirror | Anti-Scratch / Anti-Fog | <input checked="" type="checkbox"/> Silver / Red |
| 250-60-0628 | <input type="checkbox"/> Silver Mirror | Anti-Scratch / Anti-Fog | <input checked="" type="checkbox"/> Black / Red |
| 250-60-0626 | <input checked="" type="checkbox"/> Blue Mirror | Anti-Scratch / Anti-Fog | <input checked="" type="checkbox"/> Silver / Blue |

ALL DAY COMFORT

CUSTOM IMPRINTED EYEWEAR

FAST, EASY & PRECISE

PIP has the ability to custom imprint your logo and/or personalized message onto our safety eyewear. Most styles can be printed on the temples or the lenses.

Imprinted eyewear has many benefits. Using your logo or brand promotes corporate identity and provides a uniform appearance throughout your workforce.



FOR MORE INFORMATION,
FOLLOW THIS QR CODE,
OR VISIT WWW.PIPUSA.COM



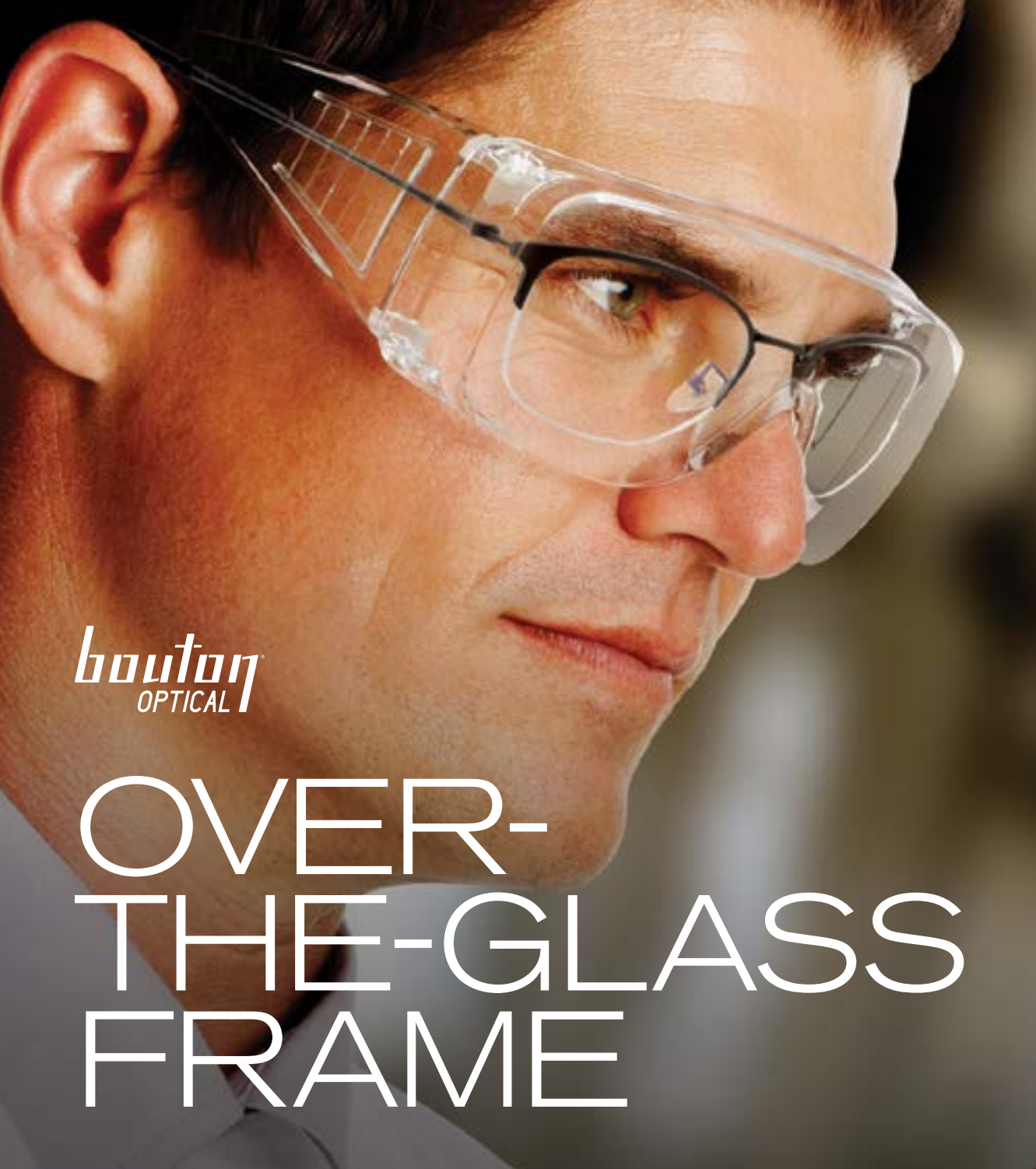



bouton
OPTICAL

OVER- THE-GLASS FRAME



SCOUT

| | | | |
|--------------------|--|---|---|
| KEY FEATURE | Popular Visitor Spec Designed to Fit Over All Personal Glasses | | |
| FIT | Over-The-Glass | | |
| BRIDGE | Molded | | |
| TEMPLE | Spatula | | |
| BASE CURVE | 4 | | |
| STANDARDS MET | ANSI Z87.1+ | CSA Z94.3 - <i>Styles Indicated Below</i>  | |
| STYLE NUMBER | LENS | COATING | FRAME |
| 250-99-0900 | ■ Clear | Anti-Scratch | ■ Clear |
| 250-99-0901 | ■ Gray | Anti-Scratch | ■ Gray |
| 250-99-0980 | ■ Clear | Uncoated | ■ Clear  |

FITS OVER MOST



RANGER

| | | | |
|-----------------------------|---|--------------|---------|
| KEY FEATURE | Slimmer Design Fits Over Smaller Personal Eyewear | | |
| FIT | Over-The-Glass | | |
| BRIDGE | Molded | | |
| TEMPLE | Spatula | | |
| BASE CURVE | 6 | | |
| STANDARDS MET | ANSI Z87.1+ | | |
| STYLE NUMBER | LENS | COATING | FRAME |
| 250-37-0900 | ■ Clear | Anti-Scratch | ■ Clear |
| 250-37-0980 | ■ Clear | Uncoated | ■ Clear |

ZENON Z28

| | | | |
|-----------------------------|---|--------------|---------|
| KEY FEATURE | OTG Design with Adjustable Length Temples | | |
| FIT | Over-The-Glass | | |
| BRIDGE | Molded | | |
| TEMPLE | Spatula | | |
| BASE CURVE | 4 | | |
| STANDARDS MET | ANSI Z87.1+ | | |
| STYLE NUMBER | LENS | COATING | FRAME |
| 250-03-0000 | ■ Clear | Anti-Scratch | □ Black |
| 250-03-0001 | ■ Gray | Anti-Scratch | □ Black |
| 250-03-0080 | ■ Clear | Uncoated | □ Black |

OVERSITE

| | | | |
|-----------------------------|--|-------------------------|----------------|
| KEY FEATURE | Fully Adjustable OTG Design for a Customized Fit | | |
| FIT | Over-The-Glass | | |
| BRIDGE | Molded | | |
| TEMPLE | Fully Adjustable, Co-Molded | | |
| BASE CURVE | 3 | | |
| STANDARDS MET | ANSI Z87.1+ | | |
| STYLE NUMBER | LENS | COATING | FRAME |
| 250-98-0080 | ■ Clear | Uncoated | □ Black / Gray |
| 250-98-0000 | ■ Clear | Anti-Scratch | □ Black / Gray |
| 250-98-0013 | ■ IR Filter 3.0 | Anti-Scratch | □ Black / Gray |
| 250-98-0020 | ■ Clear | Anti-Scratch / Anti-Fog | □ Black / Gray |

PRESCRIPTION EYEWEAR OR USE AS A VISITOR SPECTACLE



bouton
OPTICAL

HYBRID STYLE



FUSELAGE

| KEY FEATURE | Adapts to Any Working Condition with Dust Goggle Conversion | | |
|--------------------|---|---------------------------------|---------|
| FIT | Universal | | |
| BRIDGE | Molded | | |
| TEMPLE | Bayonet, Rubber Tips | | |
| BASE CURVE | 8 | | |
| STANDARDS MET | ANSI Z87.1+ | | |
| STYLE NUMBER | LENS | COATING | FRAME |
| <u>250-50-0420</u> | <input type="checkbox"/> Clear | Anti-Scratch / Anti-Fog | ■ Black |
| <u>250-50-0421</u> | <input type="checkbox"/> Gray | Anti-Scratch / Anti-Fog | ■ Black |
| <u>250-50-0422</u> | <input type="checkbox"/> I/O | Anti-Scratch / Anti-Fog | ■ Black |
| <u>250-50-0425</u> | <input type="checkbox"/> Silver Mirror | Anti-Scratch / Anti-Fog | ■ Black |
| <u>250-50-0426</u> | <input type="checkbox"/> Blue Mirror | Anti-Scratch / Anti-Fog | ■ Black |
| <u>250-50-0429</u> | <input type="checkbox"/> Amber | Anti-Scratch / Anti-Fog | ■ Black |
| <u>250-50-0520</u> | <input type="checkbox"/> Clear | Anti-Scratch / FogLess® 3Sixty™ | ■ Black |
| <u>250-50-0521</u> | <input type="checkbox"/> Gray | Anti-Scratch / FogLess® 3Sixty™ | ■ Black |

FUSELAGE READERS

| STYLE NUMBER | LENS | COATING | FRAME | DIOPTRER |
|--------------------|--------------------------------|-------------------------|---------|----------|
| <u>250-51-0015</u> | <input type="checkbox"/> Clear | Anti-Scratch / Anti-Fog | ■ Black | 1.50 |
| <u>250-51-0020</u> | <input type="checkbox"/> Clear | Anti-Scratch / Anti-Fog | ■ Black | 2.00 |
| <u>250-51-0025</u> | <input type="checkbox"/> Clear | Anti-Scratch / Anti-Fog | ■ Black | 2.50 |
| <u>250-51-0030</u> | <input type="checkbox"/> Clear | Anti-Scratch / Anti-Fog | ■ Black | 3.00 |

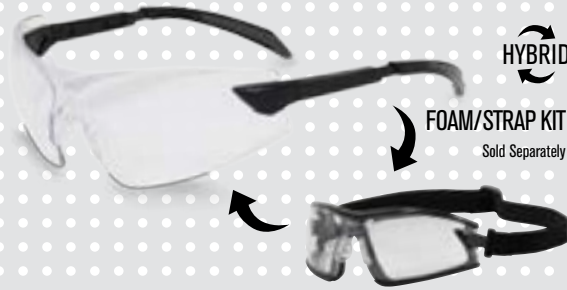

CEFIRO

| | | | |
|-------------------------------------|--|-------------------------|---------|
| KEY FEATURE | Foam Padded Design Converts to a Dust Goggle | | |
| FIT | Narrow | | |
| BRIDGE | Rubber | | |
| TEMPLE | Bayonet | | |
| BASE CURVE | 8 | | |
| STANDARDS MET | ANSI Z87.1+ | | |
| STYLE NUMBER | LENS | COATING | FRAME |
| <u>250-CE-10090</u> | <input type="checkbox"/> Clear | Anti-Scratch / Anti-Fog | ■ Black |
| <u>250-CE-10091</u> | <input type="checkbox"/> Gray | Anti-Scratch / Anti-Fog | ■ Black |
| <u>250-CE-10092</u> | <input type="checkbox"/> I/O | Anti-Scratch / Anti-Fog | ■ Black |
| <u>250-CE-10093</u> | <input type="checkbox"/> Blue Mirror | Anti-Scratch / Anti-Fog | ■ Black |
| <u>250-CE-10095</u> | <input type="checkbox"/> Silver Mirror | Anti-Scratch / Anti-Fog | ■ Black |

SUPERSONIC

| | | | |
|------------------------------------|---|-------------------------|---------|
| KEY FEATURE | Fully Adjustable Temples, and an Optional Dust Goggle Kit | | |
| FIT | Universal | | |
| BRIDGE | Rubber | | |
| TEMPLE | Fully Adjustable, Rubber Tips | | |
| BASE CURVE | 9 | | |
| STANDARDS MET | ANSI Z87.1+ | | |
| STYLE NUMBER | LENS | COATING | FRAME |
| <u>250-34-0020</u> | <input type="checkbox"/> Clear | Anti-Scratch / Anti-Fog | ■ Black |
| <u>250-34-0021</u> | <input type="checkbox"/> Gray | Anti-Scratch / Anti-Fog | ■ Black |
| <u>250-34-0010</u> | <input type="checkbox"/> Clear Anti-Reflective™ PLUS | Anti-Scratch | ■ Black |
| <u>250-34-0226</u> | <input type="checkbox"/> I/O Blue | Anti-Scratch / Anti-Fog | ■ Black |
| <u>250-34-0031</u> | <input type="checkbox"/> Gradient | Anti-Scratch / Anti-Fog | ■ Black |
| <u>250-34-FOAM</u> | --- | Foam / Strap Kit | ■ Black |

ZENON Z12F

| | | | |
|------------------------------------|---------------------------------------|-------------------------|---------|
| KEY FEATURE | Foam Lined Version of the Popular Z12 | | |
| FIT | Universal | | |
| BRIDGE | Molded | | |
| TEMPLE | Spatula | | |
| BASE CURVE | 9.5 | | |
| STANDARDS MET | ANSI Z87.1+ | | |
| STYLE NUMBER | LENS | COATING | FRAME |
| <u>250-01-F020</u> | <input type="checkbox"/> Clear | Anti-Scratch / Anti-Fog | ■ Black |
| <u>250-01-F021</u> | <input type="checkbox"/> Gray | Anti-Scratch / Anti-Fog | ■ Black |
| <u>250-01-F022</u> | <input type="checkbox"/> I/O | Anti-Scratch / Anti-Fog | ■ Black |

FOAM LINING PROTECTS AGAINST DEBRIS & AIRBORNE PARTICLES



RUBBER
TEMPLE TIPS

ZENON Z12 READERS

| KEY FEATURE | Reader Version of the Popular Z12 Style in +0.25 Diopters | | | |
|-----------------------------|---|--------------|--------------------------------|---------|
| FIT | Universal | | | |
| BRIDGE | Rubber | | | |
| TEMPLE | Spatula, Co-Molded | | | |
| BASE CURVE | 10 | | | |
| STANDARDS MET | ANSI Z87.1+ | | | |
| STYLE NUMBER | LENS | COATING | FRAME | DIOPTER |
| 250-27-0010 | <input type="checkbox"/> Clear | Anti-Scratch | <input type="checkbox"/> Clear | 1.00 |
| 250-27-0012 | <input type="checkbox"/> Clear | Anti-Scratch | <input type="checkbox"/> Clear | 1.25 |
| 250-27-0015 | <input type="checkbox"/> Clear | Anti-Scratch | <input type="checkbox"/> Clear | 1.50 |
| 250-27-0017 | <input type="checkbox"/> Clear | Anti-Scratch | <input type="checkbox"/> Clear | 1.75 |
| 250-27-0020 | <input type="checkbox"/> Clear | Anti-Scratch | <input type="checkbox"/> Clear | 2.00 |
| 250-27-0022 | <input type="checkbox"/> Clear | Anti-Scratch | <input type="checkbox"/> Clear | 2.25 |
| 250-27-0025 | <input type="checkbox"/> Clear | Anti-Scratch | <input type="checkbox"/> Clear | 2.50 |
| 250-27-0027 | <input type="checkbox"/> Clear | Anti-Scratch | <input type="checkbox"/> Clear | 2.75 |
| 250-27-0030 | <input type="checkbox"/> Clear | Anti-Scratch | <input type="checkbox"/> Clear | 3.00 |
| 250-27-0115 | <input type="checkbox"/> Gray | Anti-Scratch | <input type="checkbox"/> Gray | 1.50 |
| 250-27-0120 | <input type="checkbox"/> Gray | Anti-Scratch | <input type="checkbox"/> Gray | 2.00 |
| 250-27-0125 | <input type="checkbox"/> Gray | Anti-Scratch | <input type="checkbox"/> Gray | 2.50 |
| 250-27-0130 | <input type="checkbox"/> Gray | Anti-Scratch | <input type="checkbox"/> Gray | 3.00 |

ZENON Z13 READERS

| KEY FEATURE | Reader Version of the Popular Z13 Style in +0.25 Diopters | | | |
|-----------------------------|---|--------------|--------------------------------|---------|
| FIT | Universal | | | |
| BRIDGE | Molded | | | |
| TEMPLE | Rubber Tips | | | |
| BASE CURVE | 10 | | | |
| STANDARDS MET | ANSI Z87.1+ | | | |
| STYLE NUMBER | LENS | COATING | FRAME | DIOPTER |
| 250-26-0010 | <input type="checkbox"/> Clear | Anti-Scratch | <input type="checkbox"/> Clear | 1.00 |
| 250-26-0012 | <input type="checkbox"/> Clear | Anti-Scratch | <input type="checkbox"/> Clear | 1.25 |
| 250-26-0015 | <input type="checkbox"/> Clear | Anti-Scratch | <input type="checkbox"/> Clear | 1.50 |
| 250-26-0017 | <input type="checkbox"/> Clear | Anti-Scratch | <input type="checkbox"/> Clear | 1.75 |
| 250-26-0020 | <input type="checkbox"/> Clear | Anti-Scratch | <input type="checkbox"/> Clear | 2.00 |
| 250-26-0022 | <input type="checkbox"/> Clear | Anti-Scratch | <input type="checkbox"/> Clear | 2.25 |
| 250-26-0025 | <input type="checkbox"/> Clear | Anti-Scratch | <input type="checkbox"/> Clear | 2.50 |
| 250-26-0030 | <input type="checkbox"/> Clear | Anti-Scratch | <input type="checkbox"/> Clear | 3.00 |

READING MAG

bouton
OPTICAL



LADY EVA® READER

| KEY FEATURE | Safety Readers Engineered For Women | | | |
|-----------------------------|-------------------------------------|--------------|--|---------|
| FIT | Women | | | |
| BRIDGE | Molded | | | |
| TEMPLE | Rubber Tips | | | |
| BASE CURVE | 10 | | | |
| STANDARDS MET | ANSI Z87.1+ | | | |
| STYLE NUMBER | LENS | COATING | FRAME | DIOPTER |
| 250-12-0100 | <input type="checkbox"/> Clear | Anti-Scratch | <input checked="" type="checkbox"/> Clear / Pink | 1.00 |
| 250-12-0125 | <input type="checkbox"/> Clear | Anti-Scratch | <input checked="" type="checkbox"/> Clear / Pink | 1.25 |
| 250-12-0150 | <input type="checkbox"/> Clear | Anti-Scratch | <input checked="" type="checkbox"/> Clear / Pink | 1.50 |
| 250-12-0175 | <input type="checkbox"/> Clear | Anti-Scratch | <input checked="" type="checkbox"/> Clear / Pink | 1.75 |
| 250-12-0200 | <input type="checkbox"/> Clear | Anti-Scratch | <input checked="" type="checkbox"/> Clear / Pink | 2.00 |
| 250-12-0225 | <input type="checkbox"/> Clear | Anti-Scratch | <input checked="" type="checkbox"/> Clear / Pink | 2.25 |
| 250-12-0250 | <input type="checkbox"/> Clear | Anti-Scratch | <input checked="" type="checkbox"/> Clear / Pink | 2.50 |
| 250-12-0275 | <input type="checkbox"/> Clear | Anti-Scratch | <input checked="" type="checkbox"/> Clear / Pink | 2.75 |
| 250-12-0300 | <input type="checkbox"/> Clear | Anti-Scratch | <input checked="" type="checkbox"/> Clear / Pink | 3.00 |



RUBBER
NOSE BRIDGE

MAG READERS

| KEY FEATURE | Safety Readers in a Semi-Rimless Design | | | |
|-----------------------------|--|--------------|---|---------|
| FIT | Universal | | | |
| BRIDGE | Rubber | | | |
| TEMPLE | Rubber Tips | | | |
| BASE CURVE | 8 | | | |
| STANDARDS MET | ANSI Z87.1+ | | | |
| STYLE NUMBER | LENS | COATING | FRAME | DIOPTER |
| 250-25-0010 | <input type="checkbox"/> Clear | Anti-Scratch | <input checked="" type="checkbox"/> Black | 1.00 |
| 250-25-0015 | <input type="checkbox"/> Clear | Anti-Scratch | <input checked="" type="checkbox"/> Black | 1.50 |
| 250-25-0020 | <input type="checkbox"/> Clear | Anti-Scratch | <input checked="" type="checkbox"/> Black | 2.00 |
| 250-25-0025 | <input type="checkbox"/> Clear | Anti-Scratch | <input checked="" type="checkbox"/> Black | 2.50 |
| 250-25-0030 | <input type="checkbox"/> Clear | Anti-Scratch | <input checked="" type="checkbox"/> Black | 3.00 |
| 250-25-0115 | <input checked="" type="checkbox"/> Gray | Anti-Scratch | <input checked="" type="checkbox"/> Black | 1.50 |
| 250-25-0120 | <input checked="" type="checkbox"/> Gray | Anti-Scratch | <input checked="" type="checkbox"/> Black | 2.00 |
| 250-25-0125 | <input checked="" type="checkbox"/> Gray | Anti-Scratch | <input checked="" type="checkbox"/> Black | 2.50 |
| 250-25-0130 | <input checked="" type="checkbox"/> Gray | Anti-Scratch | <input checked="" type="checkbox"/> Black | 3.00 |

DOUBLE MAG READERS - TOP & BOTTOM DIOPTER

| STYLE NUMBER | LENS | COATING | FRAME | DIOPTER |
|-----------------------------|--------------------------------|-------------------------|---|---------|
| 250-25-1515 | <input type="checkbox"/> Clear | Anti-Scratch / Anti-Fog | <input checked="" type="checkbox"/> Black | 1.50 |
| 250-25-2020 | <input type="checkbox"/> Clear | Anti-Scratch / Anti-Fog | <input checked="" type="checkbox"/> Black | 2.00 |
| 250-25-2525 | <input type="checkbox"/> Clear | Anti-Scratch / Anti-Fog | <input checked="" type="checkbox"/> Black | 2.50 |



HYBRID

DUST GOGGLE
STRAP INCLUDED

FUSELAGE READERS

| KEY FEATURE | Top Selling Fuselage Dust Goggle in a Reader Version | | | |
|-----------------------------|--|-------------------------|---|---------|
| FIT | Universal | | | |
| BRIDGE | Molded | | | |
| TEMPLE | Bayonet, Rubber Tips | | | |
| BASE CURVE | 8 | | | |
| STANDARDS MET | ANSI Z87.1+ | | | |
| STYLE NUMBER | LENS | COATING | FRAME | DIOPTER |
| 250-51-0015 | <input type="checkbox"/> Clear | Anti-Scratch / Anti-Fog | <input checked="" type="checkbox"/> Black | 1.50 |
| 250-51-0020 | <input type="checkbox"/> Clear | Anti-Scratch / Anti-Fog | <input checked="" type="checkbox"/> Black | 2.00 |
| 250-51-0025 | <input type="checkbox"/> Clear | Anti-Scratch / Anti-Fog | <input checked="" type="checkbox"/> Black | 2.50 |
| 250-51-0030 | <input type="checkbox"/> Clear | Anti-Scratch / Anti-Fog | <input checked="" type="checkbox"/> Black | 3.00 |

NIFIERS



FOGLESS³SIXTY[™]
TECHNOLOGY

CONTEMPO

| | |
|----------------|---|
| KEY FEATURE | Modern Styling with Swivel Headband Adjustment |
| APPLICATIONS | Industrial, Construction, Medical |
| FRAME MATERIAL | PVC |
| FIT | Will Fit Over Prescription Glasses |
| BASE CURVE | 5.75 |
| STANDARDS MET | ANSI Z87.1+ CSA Z94.3 - <i>Styles Indicated Below</i> 🍁 |

INDIRECT VENTILATION

| STYLE NUMBER | LENS | COATING | FRAME | HEADBAND |
|-------------------------|---------|-------------------------|--------|-------------------|
| 251-5300-000 | ■ Clear | Anti-Scratch | ■ Blue | Elastic |
| 251-5300-400 | ■ Clear | Anti-Scratch / Anti-Fog | ■ Blue | Elastic |
| 251-5300-400-RHB | ■ Clear | Anti-Scratch / Anti-Fog | ■ Blue | Neoprene Rubber 🍁 |
| 251-5300-402 | ■ Gray | Anti-Scratch / Anti-Fog | ■ Blue | Elastic |

FORTIS II

| | |
|----------------|--|
| KEY FEATURE | Lightweight Goggle with Comfortable Sealing Properties |
| APPLICATIONS | Industrial, Construction, Medical |
| FRAME MATERIAL | Synthetic Rubber |
| FIT | Will Fit Over Some Prescription Glasses |
| BASE CURVE | 5 |
| STANDARDS MET | ANSI Z87.1+, ANSI D3 Droplet |

INDIRECT VENTILATION

| STYLE NUMBER | LENS | COATING | FRAME | HEADBAND |
|------------------------|---------|-------------------------|--------|-----------------|
| 251-80-0020 | ■ Clear | Anti-Scratch / Anti-Fog | ■ Gray | Elastic |
| 251-80-0020-RHB | ■ Clear | Anti-Scratch / Anti-Fog | ■ Gray | Neoprene Rubber |

STONE

| | |
|----------------|---|
| KEY FEATURE | Optional Visor Attachment for Face Protection |
| APPLICATIONS | Industrial, Construction, Medical |
| FRAME MATERIAL | PVC |
| FIT | Will Fit Over Prescription Glasses |
| BASE CURVE | 5 |
| STANDARDS MET | ANSI Z87.1+, ANSI D3 Droplet |

INDIRECT VENTILATION

| STYLE NUMBER | LENS | COATING | FRAME | HEADBAND |
|--------------------|--|---|--------|----------|
| 251-60-0020 | ■ Clear | Anti-Scratch / FogLess [®] 3Sixty [™] | ■ Gray | Elastic |
| 251-60-000V | Visor Only - Polycarbonate - ANSI Z87.1+ | | | |



▼ **251-60-000V**

EXTENDED FACE PROTECTION

Sold Separately

SUPERIOR COMFORT & HIGH PERFORMANCE

bouton
OPTICAL

PREMIUM GOGGLES

ELIMINATE FOGGING



ANTI-FOG
DOUBLE LENS
TECHNOLOGY

REACTION

| | |
|----------------|---|
| KEY FEATURE | Dual Lens Design for Ultimate Anti-Fog Properties |
| APPLICATIONS | Industrial, Construction, Medical |
| FRAME MATERIAL | PVC |
| FIT | Will Not Fit Over Prescription Glasses |
| BASE CURVE | 5.75 |
| STANDARDS MET | ANSI Z87.1+, ANSI D3 Droplet |

INDIRECT VENTILATION

| STYLE NUMBER | LENS | COATING | FRAME | HEADBAND |
|------------------------|---------|----------------------------|--------|--------------------|
| 251-65-0020 | ■ Clear | Anti-Scratch / Anti-Fog | ■ Gray | Elastic |
| 251-65-0020-RHB | ■ Clear | Anti-Scratch / Anti-Fog | ■ Gray | Neoprene Rubber |
| 251-65-0021-RHB | ■ Gray | Anti-Scratch / Anti-Fog | ■ Gray | Neoprene Rubber |





bouton
OPTICAL

ECONOMY GOGGLES

SOLUTIONS FOR ALL APPLICATIONS



BASIC

| | |
|----------------|--|
| KEY FEATURE | Popular Design for Economical Applications |
| APPLICATIONS | Industrial, Construction, Medical |
| FRAME MATERIAL | Vinyl |
| FIT | Will Fit Over Prescription Glasses |
| BASE CURVE | Flat |
| STANDARDS MET | ANSI Z87.1+ |

INDIRECT VENTILATION

| STYLE NUMBER | LENS | COATING | FRAME | HEADBAND |
|----------------------------|--------------------------------|--------------------|--------------------------------|----------|
| <u>248-4401-300</u> | <input type="checkbox"/> Clear | Uncoated | <input type="checkbox"/> Clear | Elastic |
| <u>248-4401-400</u> | <input type="checkbox"/> Clear | Anti-Scratch / Fog | <input type="checkbox"/> Clear | Elastic |

DIRECT VENTILATION

| STYLE NUMBER | LENS | COATING | FRAME | HEADBAND |
|----------------------------|--------------------------------|--------------------|--------------------------------|----------|
| <u>248-4400-300</u> | <input type="checkbox"/> Clear | Uncoated | <input type="checkbox"/> Clear | Elastic |
| <u>248-4400-400</u> | <input type="checkbox"/> Clear | Anti-Scratch / Fog | <input type="checkbox"/> Clear | Elastic |

SOFTSIDES

| | |
|----------------|--|
| KEY FEATURE | Soft, Flexible Vinyl Body Molds Comfortably to the Face |
| APPLICATIONS | Industrial, Construction, Medical |
| FRAME MATERIAL | Vinyl |
| FIT | Will Fit Over Prescription Glasses |
| BASE CURVE | Flat |
| STANDARDS MET | ANSI Z87.1+, ANSI D3 Droplet - <i>Styles Indicated Below</i> |

INDIRECT VENTILATION

| STYLE NUMBER | LENS | COATING | FRAME | HEADBAND |
|-----------------------------|--------------------------------|--------------------|--------------------------------|----------|
| <u>248-5190-300B</u> | <input type="checkbox"/> Clear | Anti-Scratch | <input type="checkbox"/> Clear | Elastic |
| <u>248-5190-400B</u> | <input type="checkbox"/> Clear | Anti-Scratch / Fog | <input type="checkbox"/> Clear | Elastic |

DIRECT VENTILATION

| STYLE NUMBER | LENS | COATING | FRAME | HEADBAND |
|-----------------------------|--------------------------------|--------------------|--------------------------------|----------|
| <u>248-5090-300B</u> | <input type="checkbox"/> Clear | Anti-Scratch | <input type="checkbox"/> Clear | Elastic |
| <u>248-5090-400B</u> | <input type="checkbox"/> Clear | Anti-Scratch / Fog | <input type="checkbox"/> Clear | Elastic |

NON-VENTED

| STYLE NUMBER | LENS | COATING | FRAME | HEADBAND |
|-----------------------------|--------------------------------|--------------------|--------------------------------|----------|
| <u>248-5290-300B</u> | <input type="checkbox"/> Clear | Anti-Scratch | <input type="checkbox"/> Clear | Elastic |
| <u>248-5290-400B</u> | <input type="checkbox"/> Clear | Anti-Scratch / Fog | <input type="checkbox"/> Clear | Elastic |

VENTILATION OPTIONS



NON-VENTED

Non-vented goggles have no openings for airflow or ventilation.



INDIRECT VENTILATION

Indirect vented goggles help minimize fogging and should be used when there is liquid splash risk. Indirect vented goggles have hooded vents to allow indirect airflow from the work environment.



DIRECT VENTILATION

Direct vented goggles help minimize fogging and should be used when there is no liquid splash risk. Direct vented goggles have straight-line perforations that allow direct airflow from the work environment.

SAFE & RELIABLE, FITS SNUG TO THE FACE



bouton
OPTICAL

FACE PROTECTION

FACE SHIELD MATERIALS

PETG Ideal for general grinding and liquid splash applications.

POLYCARBONATE Ideal for grinding and liquid splash applications, and suitable for high heat and heavier duty applications.

MOLDED POLYCARBONATE Provide enhanced optics, including peripheral vision. Aspherical design allows for more comfortable movement.

STEEL WIRE MESH Product of choice for forestry and lumber applications. Screen mesh provides air circulation.

PETG



[251-01-5211](#)
[251-01-7214](#)
[251-01-5212](#)

MOLDED POLYCARBONATE



[251-01-7301](#)
[251-01-7401](#)

251-01-7401 features an
ERGONOMIC
TAPERED DESIGN



[251-01-7311](#)
[251-01-7312](#)
[251-01-7313](#)
[251-01-7315](#)

FLAT SHEET POLYCARBONATE



[251-01-5201](#)
[251-01-7206](#)
[251-01-7204](#)

STEEL WIRE MESH



[251-01-7701](#)

SAFETY VISORS - UNIVERSAL FIT

| STYLE NUMBER | MATERIAL | LENS | THICKNESS | SIZE | BINDING | SHAPE | STANDARDS |
|-----------------------------|-----------------|-----------------|-----------------|------------|----------|--------------------|-----------|
| 251-01-5211 | PETG | ☐ Clear | 0.040" | 8" x 15.5" | --- | Flat | ANSI Z87 |
| 251-01-5212 | PETG | ■ Medium Green | 0.040" | 8" x 15.5" | --- | Flat | ANSI Z87 |
| 251-01-7214 | PETG | ☐ Clear | 0.040" | 9" x 15.5" | Aluminum | Curved | ANSI Z87 |
| 251-01-5201 | Polycarbonate | ☐ Clear | 0.040" | 8" x 15.5" | --- | Flat | ANSI Z87+ |
| 251-01-7206 | Polycarbonate | ☐ Clear | 0.060" | 8" x 15.5" | --- | Flat | ANSI Z87+ |
| 251-01-7204 | Polycarbonate | ☐ Clear | 0.040" | 9" x 15.5" | Aluminum | Curved | ANSI Z87+ |
| 251-01-7301 | Polycarbonate | ☐ Clear | 0.078" | 8" x 15" | --- | Molded-Cylindrical | ANSI Z87+ |
| 251-01-7401 | Polycarbonate | ☐ Clear | 0.078" | 8" x 15" | --- | Molded-Aspherical | ANSI Z87+ |
| 251-01-7311 | Polycarbonate | ■ Medium Green | 0.078" | 8" x 15" | --- | Molded-Cylindrical | ANSI Z87+ |
| 251-01-7312 | Polycarbonate | ■ Dark Green | 0.078" | 8" x 15" | --- | Molded-Cylindrical | ANSI Z87+ |
| 251-01-7313 | Polycarbonate | ■ IR Filter 3.0 | 0.078" | 8" x 15" | --- | Molded-Cylindrical | ANSI Z87+ |
| 251-01-7315 | Polycarbonate | ■ IR Filter 5.0 | 0.078" | 8" x 15" | --- | Molded-Cylindrical | ANSI Z87+ |
| 251-01-7701 | Steel Wire Mesh | --- | 24 Wire per in. | 8" x 15.5" | Aluminum | Cylindrical | ANSI Z87 |

JSP® SUREFIT™ SAFETY VISORS

| | | | | | | | |
|------------------------------|---------------|---------|--------|----------|-----|-------------|-----------|
| 251-01-6201* | Polycarbonate | ☐ Clear | 0.047" | 8" x 21" | --- | Heat Formed | ANSI Z87+ |
| 251-01-6211* | Acetate | ☐ Clear | 0.047" | 8" x 21" | --- | Heat Formed | ANSI Z87+ |

JSP® Surefit™ Safety Visors only fit JSP® Surefit™ Hard Hat Bracket ([251-01-6225](#))

HEADGEAR & BRACKETS

HEADGEAR Is used when a face shield is needed, but a hard hat is not

BRACKETS Allow the attachment of a safety visor to a hard hat

All Bouton® headgear and brackets are designed with a universal hole pattern.

HEADGEAR *Used without hard hats*



[251-01-5200](#)

BRACKETS *Used with hard hats*



[251-01-5270](#)
with [251-01-7401](#)

[251-01-5271](#)
with [251-01-7401](#)

[251-01-6225](#)
with [251-01-6201](#)

HEADGEAR

| STYLE NUMBER | STYLE | HOLE PATTERN | COLOR |
|-----------------------------|----------------------------|--------------|--------|
| 251-01-5200 | Premium Fine Tooth Ratchet | Universal | ■ Blue |
| 251-01-5400 | Economy Ratchet | Universal | ■ Blue |

BRACKETS

| STYLE NUMBER | COMPATIBLE WITH | HOLE PATTERN | MATERIAL |
|---------------------------------|---|-----------------------------|----------|
| 251-01-5270 | Full Brim | Universal | Aluminum |
| 251-01-5271 | Cap Style | Universal | Aluminum |
| 251-01-6230-JSP | JSP® Evolution® Cap Style | Universal | Aluminum |
| 251-01-5225 | Cap Style Hard Hat with Universal Slots | Universal | Plastic |
| 251-01-6225** | JSP® Standard Brim & Short Brim | JSP® Surefit™ Safety Visors | Plastic |

JSP® Surefit™ Hard Hat Bracket will only fit the JSP® Surefit™ Safety Visors ([251-01-6201](#) & [251-01-6211](#))

DISPLAY YOUR BOUTON® EYEWEAR



252-CDS-12



252-CDL-06

BOUTON® EYEWEAR DISPLAYS

| STYLE NUMBER | DESCRIPTION |
|-------------------|---------------------------------------|
| 252-CDL-06 | Bouton® 6 Piece Diamond Plate Display |
| 252-CDS-12 | Bouton® 3 Sided Pop-Up Display |



BLACK NECK CORDS

- Keeps glasses close at hand for a safer workplace

STYLE NUMBER

| | |
|-----------------|------------------------|
| 252-L401 | Rugged Nylon |
| 252-L404 | Economy Slim Nylon |
| 252-L407 | Adjustable Sports Cord |

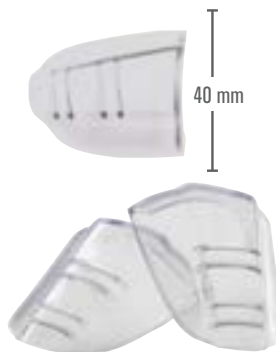

UNIVERSAL FLEX SIDESHIELDS

- Weaves through the temple for added side protection
- Molded to a bendable softness
- Temple will still fold correctly
- No parts or tools required
- Meets ANSI Z87.1+ requirements

| STYLE NUMBER | COLOR |
|--------------------|--------------------------------|
| 252-FX-0001 | <input type="checkbox"/> Clear |

Patented product of Vision Aid

IDEAL FOR SAFETY GLASSES, GOGGLES OR FACESHIELDS



INDIVIDUALLY PACKAGED



PREVENT FOGGING



STATIONARY DESIGN

LENS CLEANING TOWELETTE DISPENSER

| STYLE NUMBER | CLEANING FUNCTION | MATERIALS | RESTRICTIONS | WALL MOUNT | PACKAGING |
|-------------------|---------------------------------------|--------------------------|--------------|------------|---|
| 252-LCT100 | Anti-Fog, Anti-Static, Anti-Streaking | Pre-Moistened Towelettes | None | Yes | 100 individual towelettes, 10 dispensers per case |

LENS CLEANING STATION

| | | | | | |
|------------------|-------------------------------------|-----------------------------------|------|-----|--|
| 252-LCS08 | Anti-Fog, Anti-Static, Alcohol-Free | Spray Cleaner & Lint-free Tissues | None | Yes | 8 oz. bottle & two 300-count tissue boxes, 8 stations per case |
|------------------|-------------------------------------|-----------------------------------|------|-----|--|

FOG BUSTER

| | | | | | |
|-----------------|----------|--------------------------|------------------------------------|----|---|
| 252-FB30 | Anti-Fog | Pre-Moistened Towelettes | Mirrored or Anti-Reflective Coated | No | 30 applications per box, 6 boxes per case |
|-----------------|----------|--------------------------|------------------------------------|----|---|

UNDERSTANDING THE ANSI STANDARD

THE ANSI/ISEA 107-2015 IS NOW THE APPROVED STANDARD ON HIGH VISIBILITY APPAREL OFFERING GARMENT CATEGORIES OF PERFORMANCE CLASSES. THIS STANDARD CONSOLIDATES THE ANSI/ISEA 107-2010 FOR HIGH-VISIBILITY SAFETY APPAREL (HVSA) AND THE ANSI/ISEA 207-2011 AMERICAN NATIONAL STANDARD FOR HIGH-VISIBILITY PUBLIC SAFETY VESTS INTO A SINGLE COMPREHENSIVE STANDARD GOING FORWARD.



ANSI TYPE O

CLASS 1

Off-Road Use - Provides added visibility to workers who are not exposed to traffic.



ANSI TYPE R

CLASS 2 & CLASS 3

Roadway Use - Enhanced visibility for workers who are exposed to traffic and working against complex backgrounds.



ANSI TYPE P

CLASS 2 & CLASS 3

Public Safety - Enhanced visibility for emergency and incident responders and law enforcement personnel in both roadway and off-road environments.



ANSI CLASS E

Class E apparel includes pants, bib overalls, shorts, and gaiters. These garments are not compliant when they are worn alone, though, when combined with Class 2 or Class 3 apparel, the combination satisfies Class 3 requirements.

216 ANSI STANDARDS

218 EVERYDAY VALUE SAFETY VESTS

220 BREAKAWAY SAFETY VESTS

221 EXPANDABLE VESTS

222 SURVEYOR VESTS

224 TWO TONE VESTS

225 LIMITED FLAMMABILITY TREATED VESTS

226 PUBLIC SAFETY / EMERGENCY MANAGEMENT VESTS

227 ADDITIONAL SAFETY VESTS

228 T-SHIRTS

229 DUO-PRO™

230 SWEATSHIRTS

HI-VIS APPAREL

HI-VIS APPAREL

ANSI STANDARDS

GARMENT LABEL REQUIREMENTS

The first marking (X) indicates the garment type in accordance with Table 1. The second marking (Y) indicates the Performance Class in accordance with Table 1. The third marking (Z) indicates the garment's flame resistance statement in accordance with Section 12.2(e) and shall be represented as either "FR" or "Not FR".

For supplemental items Performance Class E, only the marking Y (indicating Performance Class) and Z (indicating flame resistance statement) are required.

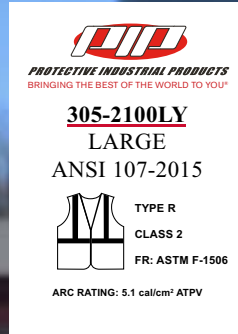

MOST CLOTHING IS

**RETAIL
READY**

MINIMUM REQUIREMENTS

| GARMENT TYPE | PERFORMANCE CLASS | BACKGROUND FABRIC | RETRO REFLECTIVE MATERIAL |
|----------------------|-------------------|----------------------|---------------------------|
| Type O | Class 1 | 217 in ² | 155 in ² |
| Type R | Class 2* | 775 in ² | 201 in ² |
| | Class 3* | 1240 in ² | 310 in ² |
| Type P | Class 2 | 450 in ² | 201 in ² |
| | Class 3 | 775 in ² | 310 in ² |
| Supplemental Items** | Class E | 465 in ² | 109 in ² |

*For the smallest size offered in Type R, a minimum of 540 in² (Performance Class 2) or 1,000 in² (Performance Class 3) of background material may be used to accommodate small-sized workers

**When a Supplemental Class E is worn with Performance Class 2 or 3, the overall classification for the ensemble shall be Performance Class 3

GET TO KNOW

THE DIFFERENCE



SOLID TRICOT



HOOK & LOOP CLOSURE



2" SILVER REFLECTIVE



INTERNAL POCKETS



POLYESTER MESH



ZIPPER CLOSURE



2" TWO TONE REFLECTIVE



(ANSI COMPLIANT TRIM)

EXTERNAL POCKETS

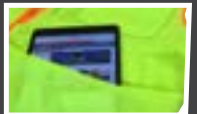

HI-VIS VESTS

EVERYDAY VALUE SAFETY VESTS

TOP-SELLING EVERYDAY VALUE VESTS

EVERYDAY VALUE VESTS

| STYLE NUMBER | HI-VIS COLOR | ANSI 107 | FABRIC | CLOSURE | POCKETS | REFLECTIVE | SIZE |
|--|---|-------------------|--------------|----------------|---------|----------------------|-----------------------------------|
| 302-V100-LY 302-V100-OR |  Lime Yellow  Orange | Type R Class 2 | Mesh | Zipper | 1 | 2" Silver Sewn-On | S/M, L/XL, 2X/3X, 4X/5X, 6X/7X |
| 302-MVG-LY 302-MVG-OR |  Lime Yellow  Orange | Type R Class 2 | Mesh | Hook & Loop | 0 | 2" Silver Sewn-On | S - 5X |
| 302-MVGZ-LY 302-MVGZ-OR |  Lime Yellow  Orange | Type R Class 2 | Mesh | Zipper | 0 | 2" Silver Sewn-On | S - 5X |
| 302-WCENG-LY 302-WCENG-OR |  Lime Yellow  Orange | Type R Class 2 | Solid Tricot | Hook & Loop | 0 | 2" Silver Sewn-On | S - 5X |
| 302-WCENGZ-LY 302-WCENGZ-OR |  Lime Yellow  Orange | Type R Class 2 | Solid Tricot | Zipper | 0 | 2" Silver Sewn-On | S - 5X |
| 302-0702-LY 302-0702-OR |  Lime Yellow  Orange | Type R Class 2 | Mesh | Hook & Loop | 2 | 2" Silver Sewn-On | S - 5X |
| 302-0702Z-LY 302-0702Z-OR |  Lime Yellow  Orange | Type R Class 2 | Mesh | Zipper | 2 | 2" Silver Sewn-On | S - 6X |
| 302-MVGZ4P-LY 302-MVGZ4P-OR |  Lime Yellow  Orange | Type R Class 2 | Mesh | Zipper | 4 | 2" Silver Sewn-On | S - 5X |
| 303-HSVE-LY 303-HSVE-OR |  Lime Yellow  Orange | Type R Class 3 | Mesh | Hook & Loop | 4 | 2" Silver Sewn-On | S - 6X |
| 303-MVGZ4P-LY 303-MVGZ4P-OR |  Lime Yellow  Orange | Type R Class 3 | Mesh | Zipper | 4 | 2" Silver Sewn-On | S - 5X |

HI-VIS VESTS

EVERYDAY VALUE SAFETY VESTS



ANSI 107
TYPE/CLASS
R2

MESH FABRIC

▲ 302-V100



ANSI 107
TYPE/CLASS
R2

▲ 302-MVGZ



ANSI 107
TYPE/CLASS
R2

▲ 302-WCENG



ANSI 107
TYPE/CLASS
R2

▲ 302-WCENGZ

UPPER & LOWER POCKETS

KEEP YOUR EQUIPMENT & DEVICES CONVENIENT AND SECURE



POCKETS
2

ANSI 107
TYPE/CLASS
R2

▲ 302-0702



POCKETS
2

ANSI 107
TYPE/CLASS
R2

▲ 302-0702Z



POCKETS
4

ANSI 107
TYPE/CLASS
R2

▲ 302-MVGZ4P



POCKETS
4

ANSI 107
TYPE/CLASS
R3

▲ 303-HSVE



POCKETS
4

ANSI 107
TYPE/CLASS
R3

▲ 303-MVGZ4P



HI-VIS VESTS

BREAKAWAY SAFETY VESTS

FIVE POINT.....



▲ 302-5PMV



▲ 302-5PV



▲ 302-0210



▲ 302-0211



X-BACK STYLES



MEETS
CAN/CSA Z96

BREAKAWAY VESTS



▲ 302-0212



▲ 303-5PMTT

FIVE POINT BREAKAWAY VESTS

| STYLE NUMBER | HI-VIS COLOR | ANSI 107 | FABRIC | CLOSURE | POCKETS | REFLECTIVE | SIZE |
|---------------------|---------------|----------|--------------|-------------|---------|-------------|--------|
| 302-5PMV-LY | ■ Lime Yellow | Type R | Mesh | Hook & Loop | 3 | 2" Silver | S - 5X |
| 302-5PMV-OR | ■ Orange | Class 2 | | | | Sewn-On | |
| 302-5PV-LY | ■ Lime Yellow | Type R | Solid Tricot | Hook & Loop | 3 | 2" Silver | S - 5X |
| 302-5PV-OR | ■ Orange | Class 2 | | | | Sewn-On | |
| 302-0212-LY | ■ Lime Yellow | Type R | Mesh | Hook & Loop | 5 | 2" Two Tone | S - 5X |
| 302-0212-OR | ■ Orange | Class 2 | | | | Sewn-On | |
| 303-5PMTT-LY | ■ Lime Yellow | Type R | Mesh | Hook & Loop | 5 | 2" Two Tone | S - 5X |
| 303-5PMTT-OR | ■ Orange | Class 3 | | | | Sewn-On | |

FIVE POINT BREAKAWAY & X-BACK VESTS

| | | | | | | | |
|--------------------|---------------|---------|------|-------------|---|---------------------|--------|
| 302-0210-LY | ■ Lime Yellow | Type R | Mesh | Hook & Loop | 3 | 2" Silver, X-Back | S - 5X |
| 302-0210-OR | ■ Orange | Class 2 | | | | Sewn-On | |
| 302-0211-LY | ■ Lime Yellow | Type R | Mesh | Hook & Loop | 5 | 2" Two Tone, X-Back | S - 6X |
| 302-0211-OR | ■ Orange | Class 2 | | | | Sewn-On | |

FOR ADDITIONAL SAFETY AROUND EXTREME TRAFFIC HAZARDS, MOVING MACHINERY OR EQUIPMENT

EXPANDABLE

FOR A UNIVERSAL FIT

EXPANDABLE VESTS

| STYLE NUMBER | HI-VIS COLOR | ANSI 107 | FABRIC | CLOSURE | POCKETS | REFLECTIVE | SIZE |
|---------------------|---------------|----------|-----------|---------|---------|-------------|-------------|
| 302-0590E-LY | ■ Lime Yellow | Type R | Mesh / | Hook & | 5 | 2" Two Tone | S/XL, 2X/5X |
| 302-0590E-OR | ■ Orange | Class 2 | Breakaway | Loop | | Sewn-On | |
| 302-USV5-LY | ■ Lime Yellow | Type R | Mesh | Zipper | 3 | 2" Two Tone | OSFM |
| 302-USV5-OR | ■ Orange | Class 2 | | | | Sewn-On | |



◀ 302-USV5



SURVEYOR VESTS

POCKETS 14
ANSI 107 TYPE/CLASS R2
▼ 302-0900

POCKETS 11
ID POCKET
ANSI 107 TYPE/CLASS R2
▼ 302-0800D

POCKETS 11
ID POCKET
ANSI 107 TYPE/CLASS R2
▼ 302-0650D

POCKETS 10
ID POCKET
ANSI 107 TYPE/CLASS R2
▲ 302-0700

POCKETS 11
ANSI 107 TYPE/CLASS R3
▲ 303-0500

POCKETS 11
ANSI 107 TYPE/CLASS R2
▲ 302-0500

POCKETS 8
ID POCKET
ANSI 107 TYPE/CLASS R2
2 MIC TABS
▲ 302-0750

SURVEYOR VESTS

| STYLE NUMBER | HI-VIS COLOR | ANSI 107 | FABRIC | CLOSURE | POCKETS | REFLECTIVE | SIZE |
|--|---|-------------------|--------------------|---------|---------|-----------------------------|--------|
| 302-0750-LY 302-0750-OR | ■ Lime Yellow ■ Orange | Type R Class 2 | Mesh | Zipper | 8 & ID | 2" Silver Sewn-On | S - 5X |
| 302-0500-YEL 302-0500-OR | ■ Lime Yellow ■ Orange | Type R Class 2 | Mesh / Solid | Zipper | 11 | 2" Two Tone Sewn-On | S - 7X |
| 302-0500S-LY 302-0500S-OR | ■ Lime Yellow ■ Orange | Type R Class 2 | Solid | Zipper | 11 | 2" Two Tone Sewn-On | S - 5X |
| 302-0500M-LY 302-0500M-OR | ■ Lime Yellow ■ Orange | Type R Class 2 | Mesh | Zipper | 11 | 2" Two Tone Sewn-On | S - 5X |
| 302-MAPM-LY 302-MAPM-OR | ■ Lime Yellow ■ Orange | Type R Class 2 | Mesh | Zipper | 11 | 2" Two Tone Sewn-On | S - 5X |
| 302-MAP-LY 302-MAP-OR | ■ Lime Yellow ■ Orange | Type R Class 2 | Solid | Zipper | 11 | 2" Two Tone Sewn-On | S - 5X |
| 302-0700-LY 302-0700-OR | ■ Lime Yellow ■ Orange | Type R Class 2 | Mesh / Solid | Zipper | 10 & ID | 2" Two Tone Sewn-On | S - 5X |
| 302-0650D-LY 302-0650D-OR | ■ Lime Yellow / Black ■ Orange / Black | Type R Class 2 | Rip Stop / Mesh | Zipper | 11 & ID | 2" Two Tone Sewn-On | S - 5X |
| 302-0800D-LY 302-0800D-OR | ■ Lime Yellow ■ Orange | Type R Class 2 | Rip Stop / Mesh | Zipper | 11 & ID | 2" Two Tone Sewn-On | S - 5X |
| 302-0800D-BK | □ Black with Hi-Vis Lime Yellow Trim | Type O Class 1 | Rip Stop / Mesh | Zipper | 11 & ID | 2" Two Tone Sewn-On | S - 5X |
| 302-0900-LY 302-0900-OR | ■ Lime Yellow ■ Orange | Type R Class 2 | Rip Stop / Mesh | Zipper | 14 | 2" Two Tone Heat Applied | M - 5X |
| 303-0500-YEL 303-0500-OR | ■ Lime Yellow ■ Orange | Type R Class 3 | Mesh / Solid | Zipper | 11 | 2" Two Tone Sewn-On | S - 5X |
| 303-0500M-LY 303-0500M-OR | ■ Lime Yellow ■ Orange | Type R Class 3 | Mesh | Zipper | 11 | 2" Two Tone Sewn-On | S - 5X |
| 303-0800D-LY 303-0800D-OR | ■ Lime Yellow ■ Orange | Type R Class 3 | Rip Stop / Mesh | Zipper | 11 & ID | 2" Two Tone Sewn-On | S - 5X |



OVERSIZED POCKETS
FOR TABLETS,
MAPS & MORE



HI-VIS VESTS

TWO TONE VESTS

ANSI COMPLIANT
CONTRASTING TRIM

2" REFLECTIVE
MATERIAL

TWO TONE

FOR IMPROVED
DAYTIME VISIBILITY

POCKETS

2



▲ 302-MV

POCKETS

2



▲ 302-0600D

▼ 302-0600D



POCKETS

3



▲ 302-MVAT

POCKETS

6



2 MIC TABS

▲ 302-MVZT

D-RING ACCESS

TWO TONE VESTS

| STYLE NUMBER | HI-VIS COLOR | ANSI 107 | FABRIC | CLOSURE | POCKETS | REFLECTIVE | SIZE |
|---------------------|--------------|----------|--------|-------------|---------|---------------------|--------|
| 302-MV-LY | Lime Yellow | Type R | Mesh | Zipper | 2 | 2" Two Tone | S - 5X |
| 302-MV-OR | Orange | Class 2 | | | | Sewn-On | |
| 302-0215-LY | Lime Yellow | Type R | Mesh | Zipper | 2 | 2" Two Tone, X-Back | S - 5X |
| 302-0215-OR | Orange | Class 2 | | | | Sewn-On | |
| 302-0600D-LY | Lime Yellow | Type R | Mesh | Zipper | 2 | 2" Two Tone | S - 5X |
| 302-0600D-OR | Orange | Class 2 | | | | Sewn-On | |
| 302-MVAT-LY | Lime Yellow | Type R | Mesh | Hook & Loop | 3 | 2" Two Tone | S - 5X |
| 302-MVAT-OR | Orange | Class 2 | | | | Sewn-On | |
| 302-MVZP-LY | Lime Yellow | Type R | Mesh | Zipper | 6 | 2" Two Tone | S - 5X |
| 302-MVZP-OR | Orange | Class 2 | | | | Sewn-On | |
| 302-MVZT-LY | Lime Yellow | Type R | Mesh | Zipper | 6 | 2" Two Tone | S - 5X |
| 302-MVZT-OR | Orange | Class 2 | | | | Sewn-On | |



LIMITED FLAMMABILITY

PREVENTS AFTER-FLAME FOR UP TO 25 WASHES



LIMITED FLAMMABILITY TREATED POLYESTER VESTS (TEST METHOD ASTM D6413)

| STYLE NUMBER | HI-VIS COLOR | ANSI 107 | FABRIC | CLOSURE | POCKETS | REFLECTIVE | SIZE |
|--|-----------------------|-------------------|--------|----------------|---------|---------------------------|------|
| 305-WCENGFR-LY 305-WCENGFR-OR | Lime Yellow Orange | Type R Class 2 | Solid | Hook & Loop | 0 | 2" FR Silver Sewn-On | Dual |
| 305-HSSVFR-LY 305-HSSVFR-OR | Lime Yellow Orange | Type R Class 3 | Solid | Hook & Loop | 0 | 2" FR Silver Sewn-On | Dual |
| 305-MVFR-LY 305-MVFR-OR | Lime Yellow Orange | Type R Class 2 | Mesh | Hook & Loop | 2 | 2" FR Two Tone Sewn-On | Dual |
| 305-HSVPFR-LY 305-HSVPFR-OR | Lime Yellow Orange | Type R Class 3 | Mesh | Hook & Loop | 2 | 2" FR Two Tone Sewn-On | Dual |
| 305-USV5FR-LY 305-USV5FR-OR | Lime Yellow Orange | Type R Class 2 | Mesh | Hook & Loop | 3 | 2" FR Two Tone Sewn-On | OSFM |
| 305-5PVFR-LY 305-5PVFR-OR | Lime Yellow Orange | Type R Class 2 | Solid | Hook & Loop | 4 | 2" FR Silver Sewn-On | Dual |

ALL TREATED VESTS INCLUDE FR REFLECTIVE TAPE

TREATED VESTS ARE DESIGNED TO PREVENT AFTER-FLAME. THEY ARE NOT DESIGNED FOR USE IN ARC FLASH OR FLASH FIRE APPLICATIONS. WHEN A FLAME SOURCE IS REMOVED FROM THE TREATED MATERIAL, THE MATERIAL WILL SELF EXTINGUISH.

HI-VIS VESTS

PUBLIC SAFETY / EMERGENCY MANAGEMENT

ANSI 107 TYPE P CLASS 2 PUBLIC SAFETY VESTS

| STYLE NUMBER | LOGO | COLOR | FABRIC | CLOSURE | POCKETS | REFLECTIVE | SIZE |
|-----------------------|-----------------|--------------------|--------------|-------------|---------|---------------------------|-------------|
| 302-PSV-RED-NL | No Logo | Red | Mesh / Solid | Zipper | 2 | 1" Split Trim Sewn-On | M/XL, 2X/5X |
| 302-PSV-RED | "FIRE" Logo | | | | | | |
| 302-PSV-BLU-NL | No Logo | Blue | Mesh / Solid | Zipper | 2 | 1" Split Trim Sewn-On | M/XL, 2X/5X |
| 302-PSV-BLU | "POLICE" Logo | | | | | | |
| 302-PSV-BLK-NL | No Logo | Black | Mesh / Solid | Zipper | 2 | 1" Split Trim Sewn-On | M/XL, 2X/5X |
| 302-PSV-BLK | "SECURITY" Logo | | | | | | |
| 302-PSV-GRN | No Logo | Green | Mesh / Solid | Zipper | 2 & ID | 1" Split Trim Sewn-On | M/XL, 2X/5X |
| 302-P070-LY | No Logo | Hi-Vis Lime Yellow | Mesh | Hook & Loop | 2 & ID | 2" Segmented Heat Applied | S/XL, 2X/5X |

▼ 302-PSV-BLK



▼ 302-PSV-RED



▼ 302-PSV-BLU



5 POINT BREAKAWAY

▼ 302-PSV-RED



POCKETS
2

▼ 302-PSV-GRN-NL



NON-ANSI INCIDENT COMMAND VESTS

| STYLE NUMBER | COLOR | FABRIC | CLOSURE | REFLECTIVE | SIZE |
|-----------------|--------------------|--------------------|-------------|-----------------|--------------------|
| 300-2501 | Purple | Polyester / Cotton | Hook & Loop | 1" White Gloss | M/XL, 2X/3X, 4X/5X |
| 300-2502 | Black | Polyester / Cotton | Hook & Loop | 1" White Gloss | M/XL, 2X/3X, 4X/5X |
| 300-2503 | Dark Blue | Polyester / Cotton | Hook & Loop | 1" White Gloss | M/XL, 2X/3X, 4X/5X |
| 300-2504 | Royal Blue | Polyester / Cotton | Hook & Loop | 1" White Gloss | M/XL, 2X/3X, 4X/5X |
| 300-2505 | Kelly Green | Polyester / Cotton | Hook & Loop | 1" White Gloss | M/XL, 2X/3X, 4X/5X |
| 300-2506 | Tan | Polyester / Cotton | Hook & Loop | 1" White Gloss | M/XL, 2X/3X, 4X/5X |
| 300-2507 | Orange | Polyester / Cotton | Hook & Loop | 1" White Gloss | M/XL, 2X/3X, 4X/5X |
| 300-2508 | Red | Polyester / Cotton | Hook & Loop | 1" White Gloss | M/XL, 2X/3X, 4X/5X |
| 300-2509 | Light Blue | Polyester / Cotton | Hook & Loop | 1" White Gloss | M/XL, 2X/3X, 4X/5X |
| 300-2510 | Yellow | Polyester / Cotton | Hook & Loop | 1" White Gloss | M/XL, 2X/3X, 4X/5X |
| 300-2511 | White | Polyester / Cotton | Hook & Loop | 1" Yellow Gloss | M/XL, 2X/3X, 4X/5X |
| 300-2512 | Hi-Vis Orange | 100% Polyester | Hook & Loop | 1" White Gloss | M/XL, 2X/3X, 4X/5X |
| 300-2513 | Hi-Vis Lime Yellow | 100% Polyester | Hook & Loop | 1" White Gloss | M/XL, 2X/3X, 4X/5X |
| 300-2514 | Forest Green | Polyester / Cotton | Hook & Loop | 1" White Gloss | M/XL, 2X/3X, 4X/5X |
| 300-2515 | Gray | Polyester / Cotton | Hook & Loop | 1" White Gloss | M/XL, 2X/3X, 4X/5X |
| 300-1502 | Black | 100% Polyester | Hook & Loop | 1" White Gloss | M/XL, 2X/3X |
| 300-1504 | Royal Blue | 100% Polyester | Hook & Loop | 1" White Gloss | M/XL, 2X/3X |
| 300-1505 | Kelly Green | 100% Polyester | Hook & Loop | 1" White Gloss | M/XL, 2X/3X |
| 300-1507 | Orange | 100% Polyester | Hook & Loop | 1" White Gloss | M/XL, 2X/3X |
| 300-1508 | Red | 100% Polyester | Hook & Loop | 1" White Gloss | M/XL, 2X/3X |
| 300-1510 | Yellow | 100% Polyester | Hook & Loop | 1" White Gloss | M/XL, 2X/3X |
| 300-1511 | White | 100% Polyester | Hook & Loop | 1" Yellow Gloss | M/XL, 2X/3X |
| 300-1516 | Pink | 100% Polyester | Hook & Loop | 1" White Gloss | M/XL, 2X/3X |

▼ 300-2511



▼ 300-2504



POCKETS FRONT & BACK
4 ID POCKETS



SAFETY VESTS

COLOR ENHANCED FOR AN ADDITIONAL LEVEL OF SAFETY IN LOW RISK ACTIVITIES



▲ 301-0150



▲ 300-0800



▲ 300-EVOR-E



▲ 300-EVOR-P



▲ 300-0900

◀ 300-1000

PREMIUM VESTS

BRIGHT COLORS HELP DISTINGUISH SPECIALTY WORKERS OR NEW HIRES

NON-ANSI SAFETY VESTS

| STYLE NUMBER | HI-VIS COLOR | ANSI 107 | FABRIC | CLOSURE | POCKETS | REFLECTIVE | SIZE |
|--|-----------------------|----------------|--------------|-------------|---------|--------------------------|--------|
| 300-1000-RD 300-1000-BL | Red Blue | Non-ANSI | Mesh / Solid | Zipper | 4 | 1" Split Trim Sewn-On | S - 5X |
| 300-0800-LY 300-0800-OR | Lime Yellow Orange | Non-ANSI | Mesh | Hook & Loop | 0 | --- | OSFM |
| 300-EVOR-E-LY 300-EVOR-E-OR | Lime Yellow Orange | Non-ANSI | Mesh | Hook & Loop | 1 | 1" Silver Sewn-On | OSFM |
| 300-EVOR-P-LY 300-EVOR-P-OR | Lime Yellow Orange | Non-ANSI | Mesh | Hook & Loop | 0 | 1 3/8" Sewn-On | OSFM |
| 300-0900-LY 300-0900-OR | Lime Yellow Orange | Non-ANSI | Mesh | Hook & Loop | 0 | 1" Two Tone Sewn-On | OSFM |
| 301-0150-LY 301-0150-OR | Lime Yellow Orange | Type O Class 1 | Mesh | Zipper | 4 | 1" Two Tone Sewn-On | S - 5X |

HI-VIS APPAREL

T-SHIRTS

NON-ANSI SAFETY T-SHIRTS MADE WITH
ANSI COMPLIANT MATERIAL



▲ 312-1200

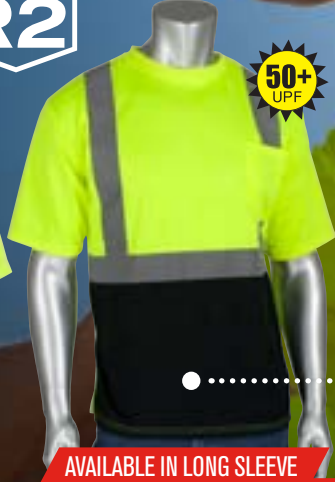

50+
UPF

AVAILABLE IN LONG SLEEVE

▲ 312-1250B



50+
UPF

BLACK
BOTTOM
HIDES DIRT

SEGMENTED TAPE

▲ 312-1360B



AVAILABLE IN LONG SLEEVE

▲ 310-CNTSN



50+
UPF

AVAILABLE IN SHORT SLEEVE

▲ 310-1150B

LIGHTWEIGHT & DURABLE PERFORMANCE WICKING MATERIAL



▲ 313-CNTSE



TWO TONE TAPE

▲ 313-CNTSP



▲ 313-1300



50+
UPF

SEGMENTED TAPE

▲ 313-1375B



X-BACK

▲ 313-1400

SHORT & LONG SLEEVE T-SHIRTS

ANSI TYPE R CLASS 2 SHORT & LONG SLEEVE T-SHIRTS

| STYLE NUMBER | HI-VIS COLOR | FEATURE | SLEEVES | ANSI 107 | FABRIC | POCKETS | REFLECTIVE | SIZE |
|---------------------|-----------------------|------------------|---------|----------------|----------|---------|--------------|--------|
| 312-1200-LY | ■ Lime Yellow | --- | Short | Type R Class 2 | Birdseye | 1 | 2" Silver | S - 5X |
| 312-1200-OR | ■ Orange | --- | Sleeve | | Mesh | | Sewn-On | |
| 312-1250B-LY | ■ Lime Yellow / Black | UV Protection | Short | Type R Class 2 | Birdseye | 1 | 2" Silver | S - 5X |
| 312-1250B-OR | ■ Orange / Black | --- | Sleeve | | Mesh | | Sewn-On | |
| 312-1350B-LY | ■ Lime Yellow / Black | UV Protection | Long | Type R Class 2 | Birdseye | 1 | 2" Silver | S - 5X |
| 312-1350B-OR | ■ Orange / Black | --- | Sleeve | | Mesh | | Sewn-On | |
| 312-1360B-LY | ■ Lime Yellow / Black | UV Protection, | Short | Type R Class 2 | Birdseye | 1 | 2" Segmented | S - 5X |
| 312-1360B-OR | ■ Orange / Black | Insect Repellent | Sleeve | | Mesh | | Heat Applied | |

ANSI TYPE R CLASS 3 SHORT & LONG SLEEVE T-SHIRTS

| | | | | | | | | |
|----------------------|-----------------------|----------------------------|--------|----------------|------------------------|---|-------------------|--------|
| 313-CNTSE-LY | ■ Lime Yellow | --- | Short | Type R Class 3 | Birdseye | 1 | 2" Silver | S - 5X |
| 313-CNTSE-OR | ■ Orange | --- | Sleeve | | Mesh | | Sewn-On | |
| 313-CNTSP-LY | ■ Lime Yellow | --- | Short | Type R Class 3 | Birdseye | 1 | 2" Two Tone | S - 5X |
| 313-CNTSP-OR | ■ Orange | --- | Sleeve | | Mesh | | Sewn-On | |
| 313-1300-LY | ■ Lime Yellow | --- | Long | Type R Class 3 | Birdseye | 1 | 2" Silver | S - 5X |
| 313-1300-OR | ■ Orange | --- | Sleeve | | Mesh | | Sewn-On | |
| 313-1375B-LY | ■ Lime Yellow / Black | UV Protection, | Long | Type R Class 3 | Birdseye | 1 | 2" Segmented | S - 5X |
| 313-1375B-OR | ■ Orange / Black | Insect Repellent | Sleeve | | Mesh | | Heat Applied | |
| 313-1400-LY | ■ Lime Yellow | --- | Short | Type R Class 3 | Birdseye | 1 | 2" Silver, X-Back | S - 5X |
| 313-1400-OR | ■ Orange | --- | Sleeve | | Mesh | | Sewn-On | |
| 315-1350FR-LY | ■ Lime Yellow | Flame Resistant (PPE 2) | Long | Type R Class 3 | Cotton | 1 | FR Tape | S - 3X |
| | | | Sleeve | | 16 cal/cm ² | | Sewn-On | |

NON-ANSI SHORT & LONG SLEEVE T-SHIRTS - ANSI COMPLIANT MATERIAL

| | | | | | | | | |
|---------------------|----------------------------------|------------------------------------|--------|-----------------------------|----------|---|------|--------|
| 310-950B-LY | ■ Lime Yellow with Black Trim | UV Protection, Insect Repellent | Short | Non-ANSI / ANSI Material | Birdseye | 0 | None | S - 5X |
| | | | Sleeve | | Mesh | | | |
| 310-1150B-LY | ■ Lime Yellow with Black Trim | UV Protection, Insect Repellent | Long | Non-ANSI / ANSI Material | Birdseye | 0 | None | S - 5X |
| | | | Sleeve | | Mesh | | | |
| 310-CNTSN-LY | ■ Lime Yellow | --- | Short | Non-ANSI / ANSI Material | Birdseye | 1 | None | S - 5X |
| 310-CNTSN-OR | ■ Orange | --- | Sleeve | | Mesh | | | |
| 310-1100-LY | ■ Lime Yellow | --- | Long | Non-ANSI / ANSI Material | Birdseye | 1 | None | S - 5X |
| 310-1100-OR | ■ Orange | --- | Sleeve | | Mesh | | | |

ANSI 107 HI-VIS
SHORT SLEEVE
T-SHIRT

SEWN-IN SLEEVE

PRITEX™ 2x1 KNIT
PROTECTIVE
SLEEVE

APPLICATIONS

CONSTRUCTION
MUNICIPALITIES
SHIPYARDS
RECYCLING
HVAC



DUO-PRO™

HI-VIS T-SHIRT WITH INTEGRATED PROTECTIVE SLEEVES

| STYLE NUMBER | SHORT SLEEVE T-SHIRT | | | 2x1 KNIT PROTECTIVE SLEEVE | | |
|----------------------------|----------------------|-------------------------|--------|----------------------------|--------|---------|
| | ANSI 107 | COLOR | SIZE | ANSI 105 | LENGTH | COLOR |
| 313-CNTSELY*-PRI18W | Type R Class 2 | ■ Hi-Vis Lime Yellow | S - 5X | A2 | 18" | □ White |

Put the desired size of the shirt in place of the asterisk () in the part number

HI-VIS APPAREL

SWEATSHIRTS

SWEATSHIRTS

ANSI 107 TYPE R CLASS 3



▼ 323-1330B



▲ 323-CNSSE



▲ 323-HSSP



▲ 323-HSSE

SIDE ACCESS HAND WARMER POCKETS

BLACK BOTTOM
HELPS HIDE DIRT



WATER REPELLENT
OUTER SHELL
ON BLACK BOTTOM STYLES

HI-VIS SWEATSHIRTS

| STYLE NUMBER | HI-VIS COLOR | ANSI 107 | FABRIC | CLOSURE | POCKETS | REFLECTIVE | SIZE |
|----------------------|-----------------------|----------|---------------------|----------|---------|-----------------|--------|
| 323-CNSSE-LY | ■ Lime Yellow | Type R | 8 oz. Polyester | Pullover | 0 | 2" Silver | M - 5X |
| 323-CNSSE-OR | ■ Orange | Class 3 | Fleece | | | Sewn-On | |
| 323-HSSE-LY | ■ Lime Yellow | Type R | 8 oz. Polyester | Zipper | 1 | 2" Silver | M - 5X |
| 323-HSSE-OR | ■ Orange | Class 3 | Fleece | | | Sewn-On | |
| 323-HSSP-LY | ■ Lime Yellow | Type R | 8 oz. Polyester | Zipper | 2 | 2" Two Tone | M - 5X |
| | | Class 3 | Fleece | | | Sewn-On | |
| 323-1330B-LY | ■ Lime Yellow / Black | Type R | 10 oz. Polyester | ¼ Zipper | 2 | 2" Silver | S - 5X |
| 323-1330B-OR | ■ Orange / Black | Class 3 | Fleece | | | Sewn-On | |
| 323-1350B-LY | ■ Lime Yellow / Black | Type R | 10 oz. Polyester | Pullover | 2 | 2" Silver | S - 5X |
| 323-1350B-OR | ■ Orange / Black | Class 3 | Fleece | | | Sewn-On | |
| 323-1370B-LY | ■ Lime Yellow / Black | Type R | 10 oz. Polyester | Zipper | 3 | 2" Silver | S - 5X |
| 323-1370B-OR | ■ Orange / Black | Class 3 | Fleece | | | Sewn-On | |
| 385-1370FR-LY | ■ Lime Yellow / Black | Type R | 12 oz. Modacrylic / | Zipper | 3 | FR Heat Applied | S - 5X |
| | | Class 3 | FR Cotton | | | Segmented Tape | |



▲ 323-1350B

THE DANGERS OF COLD STRESS

KEEPING WORKERS WARM

With jackets, liners and pullovers, the principles of thermal energy are applied to ensure the worker stays as warm as possible, taking into consideration their environment.

- The wind resistance of the outer shell is critical, as it helps minimize the entrance of the denser cold air which would take the place of the warm air that is layered close to the body.
- Adding lofted or fleece insulation provides a layer that traps the warmer air beneath the shell and helps keep out the cold.
- Keeping dry also allows the worker to stay as warm as possible. Whether it's precipitation or water penetrating from the outside, or sweat generated by the worker, moisture can accelerate the effects of the cold environment and restrain the insulation's efficiency.

In order to stay warm it is important that work garments perform and remain adaptive to the work environment, activity, and duration.

- The effectiveness of the outer shell is the first consideration. High quality outer shells provide the desired resistance against wind and water, but also allow sweat to evaporate.
- In extremely cold conditions, it is better to dress in layers as opposed to wearing a jacket or coat with very thick lofts. The thicker lofts will restrict movement, which in turn means less body heat is generated. The proper insulation combined with fleece sweaters and wicking under-layers will provide optimal protection while remaining functional for the worker.
- The ability to remove layers and/or jacket linings becomes critical when there is a wide temperature differential. This will help reduce the risk of excessive wetness from sweating while still providing adequate cold protection in this environment.

CHOOSING A MATERIAL

There are various materials to consider when choosing the best thermal protection for your environment:

- **300 Denier Rip-Stop Shell Material** – durable and tear resistant material that provides wind and water resistance.
- **300 Denier Shell Material** – durable material that provides wind and water resistance
- **280 gram Polyester Fleece Insulation** – a versatile fabric that provides warmth and quick drying properties
- **Hi-Loft Polyester Fiberfill Insulation** – a built-in insulation that resists water absorption and is quilted to resist migration

THE COLD STRESS EQUATION

Low Temperature + Wind Speed + Wetness = Injuries & Illness

When the body is unable to warm itself, serious cold related illnesses and injuries may occur, and permanent tissue damage and death may result.

- Hypothermia can occur when land temperatures are above freezing or water temperatures are below 98.6°F / 37°C.
- Cold related illnesses can slowly overcome a person who has been chilled by low temperatures, brisk winds, or wet clothing.

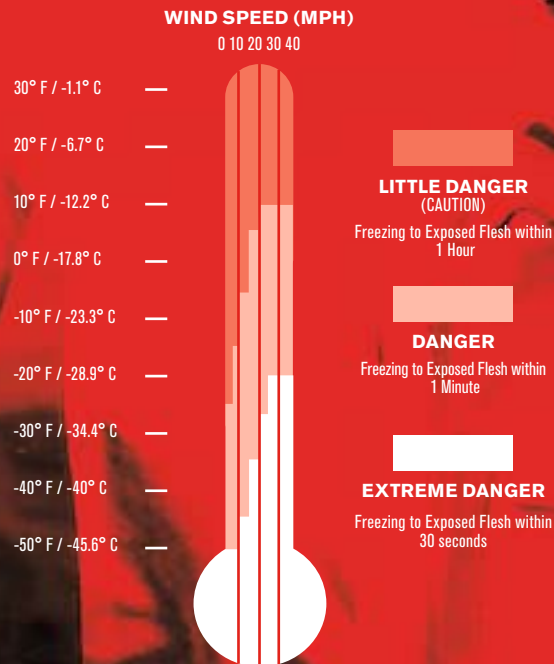

232 JACKETS & COATS

234 OVERPANTS

HI-VIS JACKETS & COATS

HI-VIS JACKETS & COATS

BOMBER JACKETS

JACKETS & COATS



▲ 333-1766



▲ 333-1762

TEAR RESISTANT
RIPSTOP SHELL

RIPSTOP SHELL

WATERPROOF COATING

INTERIOR LAYER

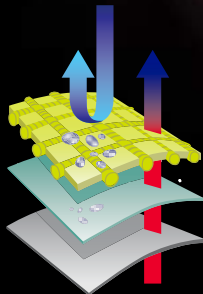

OUR RIPSTOP DIFFERENCE

Reinforcement threads are interwoven at regular intervals in a crosshatch pattern, making it resistant to tearing and ripping.



▼ 333-1770



D-RING ACCESS

REMOVABLE BLACK FLEECE LINER

LINER EASILY
ZIPS OUT

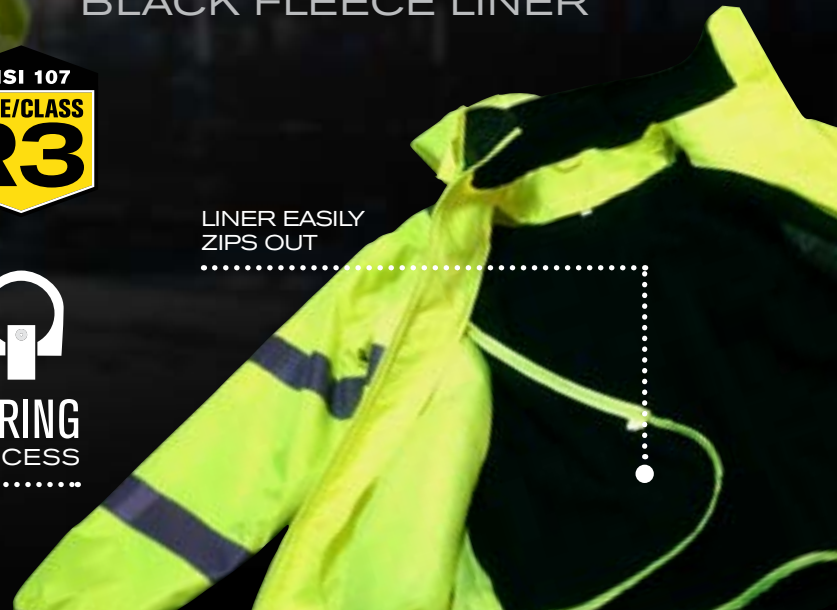

HI-VIS JACKETS & COATS

WINTER COATS / WINDBREAKER

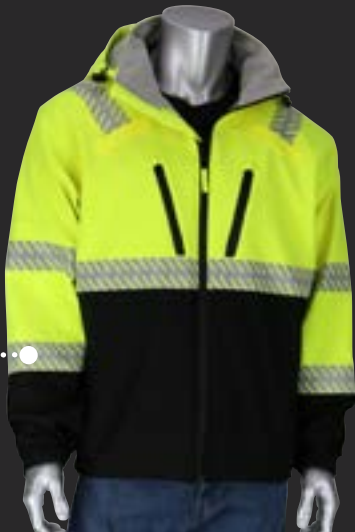

WATER RESISTANT & WINDPROOF

▲ 333-1550



▲ 333-1740



▲ 343-1755



▲ 343-1756



ANSI 107
TYPE CLASS
R2



INNER VEST & INNER JACKET - REVERSIBLE TO BLACK



SEGMENTED TAPE PROVIDES MORE BREATHABILITY

BUILT-IN

HIGH PERFORMANCE INSULATION



HI-VIS BOMBER JACKETS - REMOVABLE INSULATION

| STYLE NUMBER | HI-VIS COLOR | ANSI 107 | FABRIC | CLOSURE | POCKETS | REFLECTIVE | SIZE |
|-----------------------------|-----------------------|------------------|-------------------------------|---------|---------|-------------------|--------|
| 333-1770-LY | ■ Lime Yellow / Black | Type R Class 3 | 300 D Ripstop Polyester Shell | Zipper | 9 | 2" Silver Sewn-On | S - 5X |
| 333-1770-OR | ■ Orange / Black | | | | | | |
| 333-1766-LY | ■ Lime Yellow / Black | Type R Class 3 | 300 D Polyester Shell | Zipper | 8 | 2" Silver Sewn-On | S - 6X |
| 333-1766-OR | ■ Orange / Black | | | | | | |
| 333-1762-LY | ■ Lime Yellow | Type R Class 3 | 300 D Polyester Shell | Zipper | 8 | 2" Silver Sewn-On | S - 6X |
| 333-1762-OR | ■ Orange | | | | | | |
| 343-1756-LY | ■ Lime Yellow / Black | Type R Class 3 / | 300 D | Zipper | 6 Inner | 2" Silver Sewn-On | S - 5X |
| 343-1756-OR | ■ Orange / Black | Type R Class 2 | Polyester Shell | | 6 Outer | | |

HI-VIS COATS - BUILT-IN INSULATION

| | | | | | | | |
|-----------------------------|-----------------------|----------------|--------------------------------|--------|---|---------------------------|--------|
| 333-1550-LY | ■ Lime Yellow / Black | Type R Class 3 | 3 Ply Ripstop Outer Soft Shell | Zipper | 9 | 2" Segmented Heat Applied | S - 5X |
| 333-1740-LY | ■ Lime Yellow / Black | Type R Class 3 | 300 D Polyester Shell | Zipper | 8 | 2" Silver Sewn-On | S - 5X |
| 333-1740-OR | ■ Orange / Black | | | | | | |
| 343-1755-LY | ■ Lime Yellow | Type R Class 3 | 300 D Polyester Shell | Zipper | 4 | 2" Silver Sewn-On | S - 5X |
| 343-1755-OR | ■ Orange | | | | | | |

HI-VIS WINDBREAKER

| | | | | | | | |
|---------------------------|---------------|----------------|-----------------------|-------|---|-------------------|--------|
| 333-WB-LY | ■ Lime Yellow | Type R Class 3 | 190 T Polyester Shell | Snaps | 2 | 2" Silver Sewn-On | M - 5X |
| 333-WB-OR | ■ Orange | | | | | | |

ALL CONDITIONS

7-IN-1 COAT



LIGHTWEIGHT WINDBREAKER

▲ 333-WB

GO TO PAGE 235 FOR HIGH VISIBILITY RAINWEAR

OVERPANTS

TEAR RESISTANT
RIPSTOP

REINFORCED IN
HIGH WEAR AREAS



PAIR WITH RIPSTOP BOMBER

▲ PREVIOUS PAGE



▲ 318-1771



▲ 318-1757



▲ 319-MTP



▲ 319-GT1

ALSO AVAILABLE WITH TWO TONE TAPE



PANTS



GARMENT



COMPLIANT

HI-VIS OVERPANTS

| STYLE NUMBER | HI-VIS COLOR | ANSI 107 | FABRIC | CLOSURE | POCKETS | REFLECTIVE | SIZE |
|--------------------|---------------|----------|-----------------|-----------------------|---------|--------------|--------|
| 318-1771-LY | ■ Lime Yellow | Class E | 300 D Ripstop | Drawstring | 5 | 2" Silver | S - 5X |
| 318-1771-OR | ■ Orange | | Polyester Shell | Elastic | | Sewn-On | |
| 318-1757-LY | ■ Lime Yellow | Class E | 300 D | Elastic | 2 | 2" Silver | S - 5X |
| 318-1757-OR | ■ Orange | | Polyester Shell | | | Sewn-On | |
| 319-MTP-LY | ■ Lime Yellow | Class E | Mesh | Drawstring Elastic | 3 | 2" Two Tone | Dual |
| | | | | | | Heat Applied | |

HI-VIS GAITER

| | | | | | | | |
|----------------|---------------------------|---------|------|---------|---|------------------------|------|
| 319-GT1 | ■ Lime Yellow ■ Orange | Class E | Mesh | Elastic | 5 | 2" Silver Sewn-On | OSFM |
| 319-GT2 | ■ Lime Yellow ■ Orange | Class E | Mesh | Elastic | 5 | 2" Two Tone Sewn-On | OSFM |

PROTECTIVE WEAR DESIGNED FOR THE JOB

RAINWEAR AND SPLASHWEAR IS DESIGNED TO PROTECT WORKERS FROM LIQUID SPLASH AND CONTAMINANTS, DEFEND AGAINST HEAVY RAIN, AND PROVIDE SPLASH PROTECTION FOR PRESSURE WASHING APPLICATIONS. PRODUCTS ARE DESIGNED WITH ENHANCED FEATURES, CONSTRUCTION AND DURABILITY TO DELIVER SUPERIOR PERFORMANCE IN DEMANDING CONDITIONS.

Users are advised to conduct their own evaluations to determine the suitability of the protective clothing for each specific application. Previously worn suits should be inspected daily, especially before being put into use again, to ensure wear and tear, or prior chemical exposure has not reduced the integrity of the suit. Suits that show wear or have been in intimate contact with the chemicals should be properly disposed of.

All featured Falcon™ FR garments are treated to provide limited flammability and are self-extinguishing (ASTM D6413 test method).

236 HI-PERFORMANCE
PROTECTIVE CLOTHING

239 HI-VIS RAINWEAR

240 PROTECTIVE RAINWEAR



FALCON™

HI-PERFORMANCE PROTECTIVE CLOTHING

FALCON™ CHEMFR

Liquid splash protection in harsher environments

FALCON™ FLEX

Heavy duty protection from rain and other elements

FALCON™ HYDROFR

Uniquely designed for pressure washing

HI-VISIBILITY PROTECTIVE RAINWEAR

FALCON™ VIZ

Be seen and stay dry with high visibility rainwear

FALCON™ VIZPLUS

Hi-Visibility rainwear for extreme conditions

FALCON™ VIZAR

Hi-Visibility rainwear with AR/FR protection

PROTECTIVE RAINWEAR

FALCON™ BASE

Proven, reliable rain protection

RAINWEAR & SPLASHWEAR

HI-PERFORMANCE PROTECTIVE CLOTHING

FALCON™ CHEMFR

LIQUID SPLASH PROTECTION

PROTECT AGAINST
INCIDENTAL CONTACT
WITH CONTAMINANTS

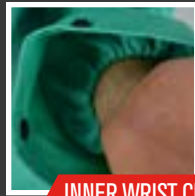

INNER WRIST CUFF

.....●
SNAP & ZIPPER
CLOSURE

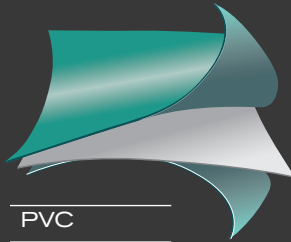

ENHANCED DURABILITY

PVC
NYLON
PVC

▲ 205-420JH

FALCON™ CHEMFR (TEST METHOD ASTM D6413)

| STYLE NUMBER | COLOR | GARMENT | THICKNESS | FABRIC | CLOSURE | POCKETS | SIZE |
|--------------|-------|--------------|-----------|-------------------|---------------|---------|--------|
| 205-420JH | Green | Jacket | 0.42 mm | PVC / Nylon / PVC | Snap & Zipper | 0 | S - 5X |
| 205-420B | Green | Bib Overalls | 0.42 mm | PVC / Nylon / PVC | --- | 0 | S - 5X |
| 205-420CV | Green | Coveralls | 0.42 mm | PVC / Nylon / PVC | Snap & Zipper | 0 | S - 5X |



LIMITED FLAMMABILITY

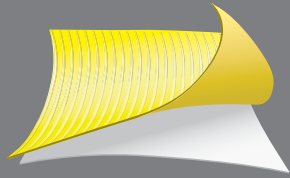

RIBBED PVC
POLYESTER

FALCON™ FLEX

| STYLE NUMBER | COLOR | GARMENT | THICKNESS | FABRIC | CLOSURE | POCKETS | SIZE |
|-----------------|--------|--------------|-----------|-----------------|---------|---------|--------|
| 201-650J | Yellow | Jacket | 0.65 mm | PVC / Polyester | Snap | 2 | S - 5X |
| 201-650B | Yellow | Bib Overalls | 0.65 mm | PVC / Polyester | --- | 0 | S - 5X |
| 201-650C | Yellow | 48" Coat | 0.65 mm | PVC / Polyester | Snap | 2 | S - 5X |

DURABLE & COMFORTABLE RAIN PROTECTION

WITH ADDED COMFORT AND FLEXIBILITY

201-650B ▼



201-650C ▼

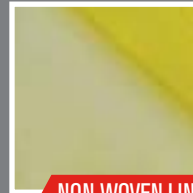

NON-WOVEN LINING

201-650J ▼



DETACHABLE
HOOD



HI-PERFORMANCE PROTECTIVE CLOTHING

FALCON™ HYDROFR

PRESSURE WASHING SPLASH PROTECTION

FALCON™ HYDROFR (TEST METHOD ASTM D6413)

| STYLE NUMBER | COLOR | GARMENT | THICKNESS | FABRIC | CLOSURE | POCKETS | SIZE |
|--------------|--------|-----------------------|-----------|-----------------------|------------------------|---------|--------|
| 205-375FR | Yellow | Jacket & Bib Overalls | 0.33 mm | PVC / Polyester / PVC | Hook & Loop and Zipper | 2 | S - 8X |

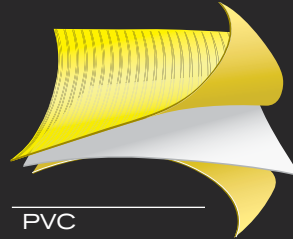

PVC
POLYESTER
PVC

EXTRA
PROTECTION

*Faceshield and headgear are not included with Falcon™ HydroFR.
GO TO PAGE 212 FOR AVAILABLE FACESHIELDS*



LIMITED FLAMMABILITY



FALCON™
HYDROFR

HI-VIS RAINWEAR

FALCON™ VIZ / FALCON™ VIZPLUS / FALCON™ VIZAR



FALCON™
VIZ

LIGHTWEIGHT
& WATERPROOF

FALCON™
VIZPLUS

BREATHABLE, DURABLE
& WATERPROOF

3M Scotchlite™
Reflective Material

FALCON™
VIZAR

ARC-RATED, DURABLE
& WATERPROOF

LIGHTWEIGHT & BREATHABLE RAINWEAR

WITH ANSI 107 COMPLIANCE FOR HI-VIS

FALCON™ VIZ

| STYLE NUMBER | HI-VIS COLOR | GARMENT | ANSI 107 | FABRIC | CLOSURE | POCKETS | REFLECTIVE | SIZE |
|--|---------------------------|---------------|-------------------|--------------------|---------|---------|----------------------|----------------------------|
| 353-1000-LY 353-1000-OR | ■ Lime Yellow ■ Orange | Jacket & Pant | Type R Class 3 | 150 D Polyester | Zipper | 2 | 2" Silver Sewn-On | S/M, L/XL, 2X/3X, 4X/5X |
| 353-1048-LY 353-1048-OR | ■ Lime Yellow ■ Orange | 48" Long Coat | Type R Class 3 | 150 D Polyester | Zipper | 2 | 2" Silver Sewn-On | S - 5X |

FALCON™ VIZPLUS

| | | | | | | | | |
|---|---------------------------|----------|-------------------|--------------------|-------------------------|---|----------------------|--------|
| 353-2000-YEL 353-2000-OR | ■ Lime Yellow ■ Orange | Jacket | Type R Class 3 | 300 D Polyester | Zipper | 5 | 2" Silver Sewn-On | S - 5X |
| 353-2001-YEL 353-2001-OR | ■ Lime Yellow ■ Orange | Overalls | Class E | 300 D Polyester | Zipper | 1 | 2" Silver Sewn-On | S - 5X |
| 353-2002-YEL 353-2002-OR | ■ Lime Yellow ■ Orange | Pants | Class E | 300 D Polyester | Elastic & Drawstring | 2 | 2" Silver Sewn-On | S - 5X |

FALCON™ VIZAR PPE 2, 16 CAL/CM² TEST METHOD ASTM F1891

| | | | | | | | | |
|----------------------|---------------|-----------------|-------------------|-------------------------|---------------------------|---|------------------------------|--------|
| 355-2500AR-LY | ■ Lime Yellow | Jacket | Type R Class 3 | 0.75 mm FR PU/Cotton | Hook & Loop and Zipper | 2 | 2" FR Silver Heat Applied | S - 5X |
| 355-2501AR-LY | ■ Lime Yellow | Bib Overalls | Class E | 0.75 mm FR PU/Cotton | Hook & Loop | 2 | 2" FR Silver Heat Applied | S - 5X |
| 355-2505AR-LY | ■ Lime Yellow | 48" Coat | Type R Class 3 | 0.75 mm FR PU/Cotton | Hook & Loop and Zipper | 2 | 2" FR Silver Heat Applied | S - 5X |



POCKETS
2
ANSI 107
TYPE/CLASS
R3

353-1000



POCKETS
2
ANSI 107
CLASS
E

353-2002

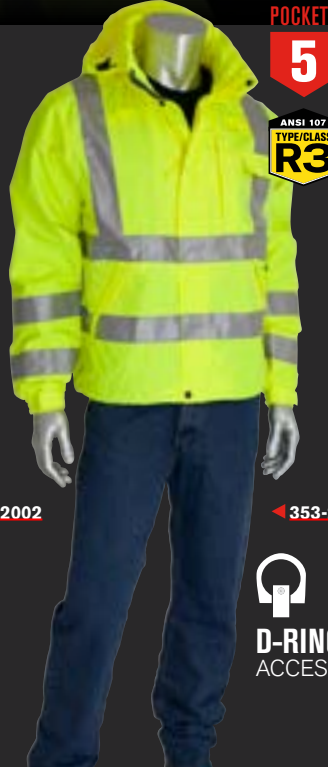

POCKETS
5
ANSI 107
TYPE/CLASS
R3

353-2000



POCKETS
2
ANSI 107
TYPE/CLASS
R3

353-1048



2
PPE
ANSI 107
TYPE/CLASS
R3

ARC-RATED PROTECTION

355-2500AR
& 355-2501AR



FALCON™
VIZ

D-RING
ACCESS

D-RING
ACCESS

PROTECTIVE RAINWEAR

FALCON™ BASE

PROVEN & RELIABLE

RAIN PROTECTION

100% WATERPROOF



▲ 201-355

▲ 201-360

▼ 205-322FR



TREATED TO PREVENT AFTER-FLAME

▼ 201-300

▼ 201-350B

FALCON™ BASE35

| STYLE NUMBER | COLOR | GARMENT | THICKNESS | FABRIC | CLOSURE | POCKETS | SIZE |
|-----------------|---------------------|------------------------|-----------|-----------------|---------|---------|--------|
| 201-350 | Yellow | Jacket & Bib Overalls | 0.35 mm | PVC / Polyester | Snap | 2 | S - 8X |
| 201-355 | Hi-Vis Lime Yellow* | Jacket & Bib Overalls | 0.35 mm | PVC / Polyester | Snap | 2 | S - 5X |
| 201-360 | Hi-Vis Orange* | Jacket & Bib Overalls | 0.35 mm | PVC / Polyester | Snap | 2 | S - 5X |
| 201-370 | Yellow | Jacket & Bib Overalls | 0.35 mm | PVC / Polyester | Snap | 2 | S - 5X |
| 201-350J | Yellow | Jacket | 0.35 mm | PVC / Polyester | Snap | 2 | S - 5X |
| 201-350B | Yellow | Bib Overalls | 0.35 mm | PVC / Polyester | Snap | 0 | S - 5X |
| 201-350P | Yellow | Elastic Pants | 0.35 mm | PVC / Polyester | Snap | 0 | S - 5X |
| 201-340 | Yellow | Jacket & Elastic Pants | 0.35 mm | PVC / Polyester | Snap | 2 | S - 5X |
| 201-300 | Yellow | 48" Coat | 0.35 mm | PVC / Polyester | Snap | 2 | S - 5X |
| 201-320 | Yellow | 60" Duster | 0.35 mm | PVC / Polyester | Snap | 2 | S - 7X |
| 201-322 | Black | 60" Duster | 0.35 mm | PVC / Polyester | Snap | 2 | S - 7X |

FALCON™ BASE35FR (TEST METHOD ASTM D6413)

| | | | | | | | |
|------------------|--------|-----------------------|---------|----------------------------|------|---|--------|
| 205-370FR | Yellow | Jacket & Bib Overalls | 0.35 mm | PVC / Polyester FR Treated | Snap | 2 | S - 7X |
| 205-300FR | Yellow | 48" Coat | 0.35 mm | PVC / Polyester FR Treated | Snap | 2 | S - 5X |
| 205-322FR | Black | 60" Duster | 0.35 mm | PVC / Polyester FR Treated | Snap | 2 | S - 7X |
| 205-320FR | Yellow | 60" Duster | 0.35 mm | PVC / Polyester FR Treated | Snap | 2 | S - 7X |

FALCON™ BASE25

| | | | | | | | |
|----------------|--------|-----------------------|---------|-----|------|---|--------|
| 201-250 | Yellow | Jacket & Bib Overalls | 0.25 mm | PVC | Snap | 2 | S - 5X |
|----------------|--------|-----------------------|---------|-----|------|---|--------|

FALCON™ BASE10

| | | | | | | | |
|----------------|--------|-----------------------|---------|-----|------|---|--------|
| 201-100 | Yellow | Jacket & Bib Overalls | 0.10 mm | PVC | Snap | 2 | S - 5X |
|----------------|--------|-----------------------|---------|-----|------|---|--------|

All jackets and coats feature a detachable hood

*Non-ANSI Hi-Vis Colors



FALCON™
BASE

FR & CUT RESISTANT APRONS MADE-TO-ORDER

APPLICATION & MATERIAL

CUT PROTECTION



Cane Mesh



DuPont™ Kevlar®

HEAT PROTECTION*

High Heat & Thermal

FR Green

Light Heat

DuPont™ Kevlar®

GENERAL PURPOSE

Duck

Denim

*Not NFPA Certified and Not Arc Rated

SIZES

| LENGTH | WIDTH |
|-----------|-----------|
| 36" - 50" | 20" - 28" |
| 36" - 50" | 20" - 28" |
| 36" - 50" | 20" - 28" |

ADDITIONAL OPTIONS

CLOSURE OPTIONS



▲ Hook & Loop Breakaway Ties



▲ Snap Closure



▲ Nylon Waist Strap with Buckle

POCKET OPTIONS



Identify your safety need, then customize your solution by choosing the **Material, Size, and Option(s)** to maximize performance.

Call PIP at 1-800-262-5755

For part numbers and pricing for your order, or if a custom option you need is not listed here.



CANE MESH

DUPONT™ KEVLAR®

FR GREEN

DUCK

DENIM

DENIM & DISPOSABLE CLOTHING

APRONS / CAPS / BEARD GUARDS / SLEEVES

APRONS

| STYLE NUMBER | 21 CFR | MATERIAL | COLOR | TYPE | WEIGHT | DIMENSIONS | POCKETS |
|----------------------------------|--------|-----------------------|---------|------------|----------|------------|---------|
| <u>200-010</u> | No | 100% Cotton Denim | ■ Blue | Reusable | 10 oz. | 28" x 38" | 0 |
| <u>200-011</u> | No | 100% Cotton Denim | ■ Blue | Reusable | 10 oz. | 28" x 38" | 1 |
| <u>200-012</u> | No | 100% Cotton Denim | ■ Blue | Reusable | 10 oz. | 28" x 38" | 2 |
| <u>200-07501</u> | Yes | PVC / Vinyl | □ White | Reusable | 8 mil | 35" x 45" | 0 |
| <u>200-08001</u> | Yes | PVC / Vinyl | □ White | Reusable | 8 mil | 35" x 35" | 0 |
| <u>200-20001</u> | Yes | PVC / Vinyl | □ White | Reusable | 20 mil | 35" x 45" | 0 |
| <u>200-12501</u> | No | Neoprene | ■ Black | Reusable | 20 mil | 33" x 45" | 0 |
| <u>200-01001</u> | Yes | Polyethylene Embossed | □ White | Single-Use | 1 mil | 24" x 42" | 0 |
| <u>200-01002</u> | Yes | Polyethylene Embossed | □ White | Single-Use | 1 mil | 28" x 46" | 0 |
| <u>200-06001</u> | Yes | Polyethylene Smooth | □ White | Single-Use | 1 mil | 28" x 46" | 0 |
| <u>200-06002</u> | Yes | Polyethylene Smooth | □ White | Single-Use | 1.25 mil | 28" x 46" | 0 |

DISPOSABLE CAPS, BEARD GUARDS & SLEEVES



DISPOSABLE CAPS, BEARD GUARDS & SLEEVES

| STYLE NUMBER | GARMENT | MATERIAL | SIZE | WEIGHT | PACKAGING |
|----------------------------------|--------------|---------------------------|----------|---------------------|----------------------------------|
| <u>200-BC18</u> | Bouffant Cap | Spun Bonded Polypropylene | 18" | 12 g/m ² | 100/Bag; 1000/Case |
| <u>200-BC21</u> | Bouffant Cap | Spun Bonded Polypropylene | 21" | 12 g/m ² | 100/Bag; 1000/Case |
| <u>200-BC24</u> | Bouffant Cap | Spun Bonded Polypropylene | 24" | 12 g/m ² | 100/Bag; 1000/Case |
| <u>200-BG01</u> | Beard Guard | Spun Bonded Polypropylene | 18" x 8" | 12 g/m ² | 100/Bag; 1000/Case |
| <u>200-91018</u> | Sleeve | Polyethylene Embossed | 18" Long | 1 mil | 10/Roll; 10 Rolls/Bag; 1000/Case |

REUSABLE & SINGLE USE APRONS



DENIM

[200-010](#)

- 100% cotton construction
- Serged seams
- Pre-shrunk
- Metal grommets to hold neck strap and waist ties

APPLICATIONS: *Manufacturing, Warehousing, Construction, Carpentry*

[200-07501](#)

- Superior flexibility
- Excellent resistance to punctures and abrasion
- Excellent resistance to oils, grease and chemicals

APPLICATIONS: *Food Handling, Industrial Maintenance, Chemical Processing*



PVC/VINYL



NEOPRENE

[200-12501](#)

- Chemical and oil resistant
- Rust-proof grommets
- Reinforced bib
- Hemmed over-edge

APPLICATIONS: *Chemical Plants, Plating Facilities, General Maintenance*

[200-01001](#)

- Resistant to fats, oil and grease
- Convenient individual packaging
- Die cut for consistent sizing

APPLICATIONS: *Food Handling and General Preparation*



POLYETHYLENE

THE DIFFERENCE BETWEEN FR AND AR

FLAME RESISTANT (FR)

Flame Resistant garments earn their designation because they are made of fabrics that are inherently resistant to or are treated to be resistant to catching fire when exposed directly to flame. The material will resist ignition and/or self-extinguish when ignited, and they will not melt. FR garments also create a thermal barrier to help protect the wearer's skin when exposed to direct heat energy and may minimize the amount of 2nd and 3rd degree burns incurred. FR fabrics include:

- **Modacrylics, Aramids and Para-aramids** are among the inherently flame resistant fabrics. They will not lose those characteristics through wear or laundering.
- **Treated Fabrics**, such as cotton and cotton blends, require FR treatment to achieve self-extinguishing properties. This treatment will eventually fade with washing but, if the garment is properly cared for, the treatment can last the life of the garment. FR treated cotton and cotton blends provide a more comfortable and affordable solution.

ARC RATED (AR)

Arc Rated (AR) garments help to provide flame and thermal protection from exposure to an electrical arc flash. AR fabrics and garments are designed and treated to help limit the exposure and burn percentage as a result of an electrical arc flash incident.

In 2015, the NFPA introduced the new term "**AR (Arc Rated)**" to help identify the critical difference between AR and FR (Flame Resistant) clothing as it applies to Arc Flash Protection.

Remember: All AR garments are flame resistant, however not all FR garments are rated for arc flash protection.

There are many variables to consider when selecting **AR** protective clothing. Most importantly the employer must perform a **Hazard Risk Analysis** for the workplace to identify risks and set the appropriate boundaries. The results of this analysis will then direct the employer into the level of protection needed.

Each AR garment is given an **Arc Thermal Performance Value (ATPV)** or **Energy Break-open Threshold (EBT)**. This value represents the level of protection the garment is tested to provide when exposed to variable levels of heat in an electric arc flash. Higher levels of protection typically require thicker and/or additional layers. The ATPV or EBT of the garment should be equal to or greater than the energy level of the work area as determined by the Hazard Risk Analysis.

The NFPA 70E should be reviewed thoroughly and regularly to ensure compliance and to be aware of any revisions or updates as they occur.

DUAL CERTIFIED PROTECTION

Dual Certified means that the materials have been tested and certified to meet both the NFPA 70E (Arc Flash Protection) and the NFPA 2112 (Flash Fire Protection) standards. The NFPA 2112-2012 requires third party certification of the garment, and all PIP NFPA 2112-2012 certified garments are UL certified. All PIP Dual-Certified apparel are identified as such.



[244 AR/FR SWEATSHIRTS](#)

[245 AR/FR SHIRTS](#)

[246 AR/FR HI-VIS VESTS](#)

[247 AR/FR ADDITIONAL CLOTHING](#)

[248 DUAL CERTIFIED CLOTHING](#)

[250 ARC FLASH PROTECTION KITS](#)

[254 ARC FLASH HEAD GEAR](#)

[256 ARC FLASH ACCESSORIES](#)

FLAME RESISTANT & ARC RATED CLOTHING

AR/FR CLOTHING

SWEATSHIRT

NFPA 70E PPE CATEGORIES

| PPE CATEGORY | PROTECTIVE EQUIPMENT | PROTECTIVE CLOTHING | MIN ARC RATING |
|--|---|---|------------------------|
|  | <ul style="list-style-type: none"> • Hard hat • Safety glasses or safety goggles (SR) • Hearing protection (ear canal inserts) • Heavy duty leather gloves* • Leather work shoes | <ul style="list-style-type: none"> • Arc rated long sleeve shirt and pants or arc rated coverall • Arc rated face shield or arc flash suit hood • Arc rated jacket, parka, rainwear or hard hat liner | 4 cal/cm ² |
|  | <ul style="list-style-type: none"> • Hard hat • Safety glasses or safety goggles (SR) • Hearing protection (ear canal inserts) • Heavy duty leather gloves* • Leather work shoes | <ul style="list-style-type: none"> • Arc rated long sleeve shirt and pants or arc rated coverall • Arc rated face shield and arc rated balaclava or arc flash suit hood • Arc rated jacket, parka, rainwear or hard hat liner | 8 cal/cm ² |
|  | <ul style="list-style-type: none"> • Hard hat • Safety glasses or safety goggles (SR) • Hearing protection (ear canal inserts) • Heavy duty leather gloves* • Leather work shoes | <ul style="list-style-type: none"> • Arc rated long sleeve shirt • Arc rated pants • Arc rated coverall • Arc rated arc flash suit jacket • Arc rated arc flash suit pants • Arc rated arc flash suit hood • Arc rated gloves • Arc rated jacket, parka, rainwear or hard hat liner | 25 cal/cm ² |
|  | <ul style="list-style-type: none"> • Hard hat • Safety glasses or safety goggles (SR) • Hearing protection (ear canal inserts) • Heavy duty leather gloves* • Leather work shoes | <ul style="list-style-type: none"> • Arc rated long sleeve shirt • Arc rated pants • Arc rated coverall • Arc rated arc flash suit jacket • Arc rated arc flash suit pants • Arc rated arc flash suit hood • Arc rated gloves • Arc rated jacket, parka, rainwear or hard hat liner | 40 cal/cm ² |

* NFPA 70E Table 130.7(C)(16) Note 1 - The combination of rubber insulating gloves and leather protectors satisfies the arc flash protection requirements.

NFPA 70E 2015 NOTABLE CHANGES

When determining which arc rating of PPE is required, the term HRC (Hazard/Risk Category) is now referred to as **"PPE Category."**

The former HRC Level 0 no longer exists. The NFPA now requires arc rated clothing for tasks that were previously identified as **Category 0.**

Arc rated balaclava hoods are required when an individual's head is inside the arc boundary. Arc rated full hoods are required when clothing rated higher than 12 cal/cm² is worn.

ANSI 107 TYPE R CLASS 3 19 CAL PROTECTION



FLAME RESISTANT
SEGMENTED TAPE



+



ARC RATED FLAME RESISTANT HI-VIS BLACK BOTTOM SWEATSHIRT

| | |
|-------------------|--|
| GARMENT | Hoodie |
| PPE CATEGORY | 2 |
| ARC RATING | 19 cal/cm ² |
| MATERIAL | Modacrylic / FR Cotton |
| WEIGHT | 12 oz. Fleece Knit |
| POCKETS | 3 |
| STANDARD | ANSI 107 Type R Class 3, NFPA 70E, ASTM F1506 |
| CLOSURE | Zipper |
| REFLECTIVE | 2" FR Segmented Heat Applied |
| SIZE | S - 5X |
| STYLE NUMBER | COLOR |
| 385-1370FR |  Hi-Vis Lime Yellow / Black |



NEXT TO SKIN COMFORT & BREATHABILITY



ARC RATED FLAME RESISTANT SHIRTS (SHORT SLEEVE T-SHIRTS SHOULD BE WORN AS AN UNDERGARMENT ONLY)

| STYLE NUMBER | COLOR | GARMENT | PPE CATEGORY | ARC RATING | MATERIAL | WEIGHT | POCKETS | STANDARD | CLOSURE | REFLECTIVE | SIZE |
|--|---|-------------------------|--------------|-------------------------|-------------|--------------|---------|--|----------|----------------------|--------|
| 385-FRLS-LG 385-FRLS-NV 385-FRLS-OR | <input type="checkbox"/> Light Gray <input type="checkbox"/> Navy <input type="checkbox"/> Orange | Long Sleeve T-Shirt | 2 | 11 cal/cm ² | 100% Cotton | 6.5 oz. Knit | 1 | NFPA 70E, ASTM F1506 | Pullover | None | M - 3X |
| 385-FRHN-LG 385-FRHN-NV 385-FRHN-OR | <input type="checkbox"/> Light Gray <input type="checkbox"/> Navy <input type="checkbox"/> Orange | Long Sleeve Henley | 2 | 11 cal/cm ² | 100% Cotton | 6.5 oz. Knit | 1 | NFPA 70E, ASTM F1506 | Pullover | None | M - 3X |
| 385-FRSS-LG 385-FRSS-NV | <input type="checkbox"/> Light Gray <input type="checkbox"/> Navy | Short Sleeve T-Shirt | 2 | 11 cal/cm ² | 100% Cotton | 6.5 oz. Knit | 1 | NFPA 70E, ASTM F1506 | Pullover | None | M - 3X |
| 315-1350FR | <input type="checkbox"/> Hi-Vis Lime Yellow | Long Sleeve T-Shirt | 2 | 8.6 cal/cm ² | 100% Cotton | 8 oz. Knit | 1 | ANSI 107 Type R Class 3, NFPA 70E, ASTM F1506 | Pullover | 2" Silver Sewn-On | S - 3X |

ARC RATED FLAME RESISTANT SWEATSHIRTS

| | | | | | | | | | | | |
|--|--|--------|---|------------------------|-------------|--------------------|---|----------------------|----------|------|--------|
| 385-FRPH-NV 385-FRPH-OR | <input type="checkbox"/> Navy <input type="checkbox"/> Orange | Hoodie | 2 | 20 cal/cm ² | 100% Cotton | 12 oz. Fleece Knit | 1 | NFPA 70E, ASTM F1506 | Pullover | None | M - 3X |
| 385-FRZH-NV 385-FRZH-OR | <input type="checkbox"/> Navy <input type="checkbox"/> Orange | Hoodie | 2 | 20 cal/cm ² | 100% Cotton | 12 oz. Fleece Knit | 2 | NFPA 70E, ASTM F1506 | Zipper | None | M - 3X |

AR/FR CLOTHING

HI-VIS VESTS

RESISTS IGNITION & SELF EXTINGUISHES

TO BE WORN OVER ARC RATED FR CLOTHING **ONLY**.

▼ 305-3000

▼ 305-2000



+



▼ 305-3100

▼ 305-2100

SOLID FABRIC



MESH FABRIC

NO MELT, NO DRIP

ARC RATED FLAME RESISTANT HI-VIS VESTS

| STYLE NUMBER | HI-VIS COLOR | ANSI 107 | PPE CATEGORY | ARC RATING | MATERIAL | WEIGHT | POCKETS | STANDARD | CLOSURE | REFLECTIVE | SIZE |
|-----------------|---------------|----------------|--------------|-------------------------|------------|---------------------|---------|--------------------------------|----------------|----------------------|--------|
| 305-2000 | ■ Lime Yellow | Type R Class 2 | 1 | 5.4 cal/cm ² | Modacrylic | 6.2 oz. Woven Solid | 0 | ANSI 107, NFPA 70E, ASTM F1506 | FR Hook & Loop | 2" FR Silver Sewn-On | M - 5X |
| 305-3000 | ■ Lime Yellow | Type R Class 3 | 1 | 5.4 cal/cm ² | Modacrylic | 6.2 oz. Woven Solid | 0 | ANSI 107, NFPA 70E, ASTM F1506 | FR Hook & Loop | 2" FR Silver Sewn-On | M - 5X |
| 305-2100 | ■ Lime Yellow | Type R Class 2 | 1 | 5.1 cal/cm ² | Modacrylic | 6.2 oz. Mesh | 1 | ANSI 107, NFPA 70E, ASTM F1506 | FR Hook & Loop | 2" FR Silver Sewn-On | M - 5X |
| 305-3100 | ■ Lime Yellow | Type R Class 3 | 1 | 5.1 cal/cm ² | Modacrylic | 6.2 oz. Mesh | 1 | ANSI 107, NFPA 70E, ASTM F1506 | FR Hook & Loop | 2" FR Silver Sewn-On | M - 5X |

FR HOOK AND LOOP CLOSURE & FR REFLECTIVE TAPE AND BINDING

ARC RATED CLOTHING

- ARAMID HIGH TENACITY THREAD
- BAR TACKED AT ALL STRESS POINTS
- ULTRALIGHT STYLES AVAILABLE (*)

ARC RATED FLAME RESISTANT COVERALLS (NFPA 70E, ASTM F1506)*

| STYLE NUMBER | COLOR | MATERIAL | PPE CAT. | ARC RATING | POCKETS | CLOSURE | SIZE |
|-----------------------------|-------------------------------|-----------------------|----------|------------------------|---------|-------------|--------|
| 9100-2160D | <input type="checkbox"/> Navy | Cotton / Nylon | 2 | 8 cal/cm ² | 2 | Hook & Loop | S - 5X |
| 9100-2170D | <input type="checkbox"/> Navy | Cotton / Nylon | 2 | 12 cal/cm ² | 2 | Hook & Loop | S - 5X |
| 9100-52772 | <input type="checkbox"/> Navy | Cotton / Nylon | 3 | 25 cal/cm ² | 3 | Hook & Loop | S - 5X |
| 9100-52758 | <input type="checkbox"/> Navy | Cotton / Nylon | 3 | 33 cal/cm ² | 3 | Hook & Loop | S - 5X |
| 9100-240ULT | <input type="checkbox"/> Navy | Protera® / Ultrasoft® | 4 | 40 cal/cm ² | 2 | Hook & Loop | S - 5X |

ARC RATED FLAME RESISTANT OVERALLS (NFPA 70E, ASTM F1506)

| | | | | | | | |
|----------------------------|-------------------------------|-----------------|---|-------------------------|---|--------|--------|
| 9100-52564 | <input type="checkbox"/> Navy | Cotton / Nylon | 2 | 12 cal/cm ² | 2 | Buckle | S - 5X |
| 9100-21731 | <input type="checkbox"/> Navy | Cotton / Nylon | 3 | 25 cal/cm ² | 2 | Buckle | S - 5X |
| 9100-53680 | <input type="checkbox"/> Navy | Cotton / Nylon | 3 | 33 cal/cm ² | 2 | Buckle | S - 5X |
| 9100-52422 | <input type="checkbox"/> Navy | Cotton / Nylon | 4 | 40 cal/cm ² | 2 | Buckle | S - 5X |
| 9100-75001 | <input type="checkbox"/> Navy | Cotton / Nylon | 4 | 75 cal/cm ² | 2 | Buckle | S - 5X |
| 9100-53750 | <input type="checkbox"/> Gray | Aramid / Cotton | 4 | 100 cal/cm ² | 2 | Buckle | M - 2X |

ARC RATED FLAME RESISTANT JACKETS (NFPA 70E, ASTM F1506)

| | | | | | | | |
|------------------------------|-------------------------------|-----------------------|---|-------------------------|---|-------------|--------|
| 9100-21782 | <input type="checkbox"/> Navy | Cotton / Nylon | 2 | 12 cal/cm ² | 2 | Hook & Loop | S - 5X |
| 9100-21721 | <input type="checkbox"/> Navy | Cotton / Nylon | 3 | 25 cal/cm ² | 2 | Hook & Loop | S - 5X |
| 9100-52680 | <input type="checkbox"/> Navy | Cotton / Nylon | 3 | 33 cal/cm ² | 2 | Hook & Loop | S - 5X |
| 9100-52412 | <input type="checkbox"/> Navy | Cotton / Nylon | 4 | 40 cal/cm ² | 2 | Hook & Loop | S - 5X |
| 9100-524ULT* | <input type="checkbox"/> Navy | Protera® / Ultrasoft® | 4 | 40 cal/cm ² | 2 | Hook & Loop | S - 5X |
| 9100-75000 | <input type="checkbox"/> Navy | Cotton / Nylon | 4 | 75 cal/cm ² | 2 | Hook & Loop | S - 5X |
| 9100-52750 | <input type="checkbox"/> Gray | Aramid / Cotton | 4 | 100 cal/cm ² | 2 | Hook & Loop | M - 2X |

ARC RATED FLAME RESISTANT OVERPANTS (NFPA 70E, ASTM F1506)

| | | | | | | | |
|------------------------------|-------------------------------|-----------------------|---|------------------------|---|--------------------------|--------|
| 9100-22070 | <input type="checkbox"/> Navy | Cotton / Nylon | 2 | 12 cal/cm ² | 2 | Hook & Loop / Drawstring | S - 5X |
| 9100-530ULT* | <input type="checkbox"/> Navy | Protera® / Ultrasoft® | 4 | 40 cal/cm ² | 4 | Hook & Loop / Drawstring | S - 5X |

*ADDITIONAL COVERALL STYLES ON FOLLOWING PAGES



DUAL CERTIFIED CLOTHING

SHIRTS / JEANS



DUAL CERTIFIED

DUAL CERTIFIED MEANS THE GARMENT AND MATERIAL HAVE BEEN TESTED AND CERTIFIED BY A THIRD PARTY AND INDICATES COMPLIANCE TO TWO STANDARDS.

NFPA 70E: STANDARD FOR ELECTRICAL SAFETY IN THE WORKPLACE

NFPA 2112: STANDARD FOR PROTECTION AGAINST FLASH FIRE

385-FRWS

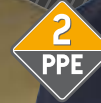

ARC RATED FLAME RESISTANT DUAL CERTIFIED CLOTHING

| STYLE NUMBER | COLOR | GARMENT | PPE CATEGORY | ARC RATING | MATERIAL | WEIGHT | POCKETS | STANDARD | CLOSURE | SIZE |
|--|---|-------------------|--------------|------------------------|----------------------------|---------------------------|---------|--|---------|---------------------------------|
| 385-FRWS-NV 385-FRWS-KH | <input type="checkbox"/> Navy <input type="checkbox"/> Khaki | Button Down | 2 | 8 cal/cm ² | 90% Cotton 10% Nylon | 7 oz. Woven FR Fabric | 2 | NFPA 70E, ASTM F1506 & NFPA 2112-2012 | Buttons | S - 4X |
| 385-FRRJ | <input type="checkbox"/> Denim | Relaxed Fit Jeans | 2 | 16 cal/cm ² | 100% Cotton Denim Twill | 13 oz. Woven FR Fabric | 5 | NFPA 70E, ASTM F1506 & NFPA 2112-2012 | Zipper | Waist: 30-50" Length: 30-36" |
| 385-FRCJ | <input type="checkbox"/> Denim | Carpenter Jeans | 2 | 16 cal/cm ² | 100% Cotton Denim Twill | 13 oz. Woven FR Fabric | 6 | NFPA 70E, ASTM F1506 & NFPA 2112-2012 | Zipper | Waist: 30-50" Length: 30-36" |

385-FRCJ

DUAL CERTIFIED CLOTHING

COVERALLS



VENTED BACK

INSECT REPELLENT

ACTION BACK

2 EXTRA LARGE
CHEST FLAP
POCKETS

NON-LOCKING
BREAKAWAY
ZIPPER

ARC RATED FLAME RESISTANT DUAL CERTIFIED COVERALLS

| STYLE NUMBER | COLOR | FEATURE | PPE CATEGORY | ARC RATING | MATERIAL | WEIGHT | POCKETS | STANDARD | CLOSURE | SIZE |
|--|---|----------------------------------|--------------|------------------------|-------------------------|--------------------------|---------|--|-------------|--------|
| 385-FRSC-NV 385-FRSC-KH | <input type="checkbox"/> Navy <input type="checkbox"/> Khaki | Multiple Pockets | 2 | 8 cal/cm ² | 90% Cotton 10% Nylon | 7 oz. Woven FR Fabric | 8 | NFPA 70E, ASTM F1506 & NFPA 2112-2012 | Zipper | S - 5X |
| 9100-2160D | <input type="checkbox"/> Navy | Action Back For Mobility | 2 | 8 cal/cm ² | 90% Cotton 10% Nylon | 7 oz. Woven FR Fabric | 2 | NFPA 70E, ASTM F1506 & NFPA 2112-2012 | Hook & Loop | S - 5X |
| 9100-2100D | <input type="checkbox"/> Tan | Vented Back For Breathability | 2 | 8 cal/cm ² | 90% Cotton 10% Nylon | 7 oz. Woven FR Fabric | 2 | NFPA 70E, ASTM F1506 & NFPA 2112-2012 | Hook & Loop | S - 5X |
| 9100-2120D | <input type="checkbox"/> Royal Blue | Vented Back For Breathability | 2 | 8 cal/cm ² | 90% Cotton 10% Nylon | 7 oz. Woven FR Fabric | 2 | NFPA 70E, ASTM F1506 & NFPA 2112-2012 | Hook & Loop | S - 5X |
| 9100-2110D | <input type="checkbox"/> Tan | Built-In Insect Repellant | 2 | 8 cal/cm ² | 90% Cotton 10% Nylon | 7 oz. Woven FR Fabric | 2 | NFPA 70E, ASTM F1506 & NFPA 2112-2012 | Hook & Loop | S - 5X |
| 9100-2170D | <input type="checkbox"/> Navy | Action Back For Mobility | 2 | 12 cal/cm ² | 90% Cotton 10% Nylon | 9 oz. Woven FR Fabric | 2 | NFPA 70E, ASTM F1506 & NFPA 2112-2012 | Hook & Loop | S - 5X |

ARC FLASH PROTECTION KITS

KIT FEATURES

ARC KITS INCLUDE:

- 1** CAP STYLE HARD HAT
EVOLUTION® 280-EV6151-OR - NON-VENTED CLASS E



- 1** STORAGE BAG
CARRY BAG: 9400-52599 OR BACK PACK: 9400-52514



- 1** DIELECTRIC SAFETY GLASSES
CAPTAIN™ 250-46-0020



WITH AN ARC SHIELD & BALACLAVA OR ARC HOOD





8 & 12 CAL ARC KITS

PIP's 8 & 12 cal Arc Flash Kits are designed to meet your PPE 2 needs (insulating glove kits and arc rated hearing protection are not included). These kits provide you with the components needed to be in compliance with the NFPA 70E Standard.

PPE 2 ARC PROTECTION KITS

| ITEM NUMBER | CLOTHING | CLOTHING STYLE NUMBER | FEATURE | BALACLAVA | ARC SHIELD | ARC RATING | STORAGE BAG |
|-----------------------------|-------------------------|-------------------------|-------------|-------------|----------------------------|------------------------|-------------|
| 9150-5388E | Dual Certified Coverall | 9100-2160D | Action Back | 9100-HDFR15 | 9400-52505 | 8 cal/cm ² | Carry Bag |
| 9150-5388EB | Dual Certified Coverall | 9100-2160D | Action Back | 9100-HDFR15 | 9400-52505 | 8 cal/cm ² | Back Pack |
| 9150-5488E | Dual Certified Coverall | 9100-2170D | Action Back | 9100-HDFR15 | 9400-52505 | 12 cal/cm ² | Carry Bag |
| 9150-5488EB | Dual Certified Coverall | 9100-2170D | Action Back | 9100-HDFR15 | 9400-52505 | 12 cal/cm ² | Back Pack |
| 9150-52804 | Jacket & Overall | 9100-21780 & 9100-52564 | 2-Piece Set | 9100-HDFR15 | 9400-52505 | 12 cal/cm ² | Back Pack |
| 9150-52810 | Jacket & Pant | 9100-21780 & 9100-22070 | 2-Piece Set | 9100-HDFR15 | 9400-52505 | 12 cal/cm ² | Carry Bag |
| 9150-53871 | Jacket & Overall | 9100-21780 & 9100-52564 | 2-Piece Set | 9100-HDFR15 | 9400-52505 | 12 cal/cm ² | Carry Bag |



12 CAL ARC HEAD GEAR KITS

PIP's 12 & 20 cal Arc Flash Head Gear Kits are designed to meet PPE 2 needs for workers (insulating glove kits, and arc rated clothing and hearing protection are not included). These kits provide you with the above-the-neck components needed to be in compliance with the new NFPA 70E 2012 standard.

PPE 2 ARC HEAD GEAR KITS

| ITEM NUMBER | BALACLAVA | ARC SHIELD | HEAD GEAR BAG | ARC RATING | STORAGE BAG |
|----------------------------|-----------------------------|----------------------------|----------------------------|------------------------|-------------|
| 9150-52508 | 9100-HDFR15 | 9400-52505 | 9400-52509 | 12 cal/cm ² | None |
| 9150-52512 | 9100-HDFR15 | 9400-52505 | 9400-52509 | 12 cal/cm ² | Carry Bag |
| 9150-52500 | 9100-HDFR15 | 9400-52505 | 9400-52509 | 12 cal/cm ² | Back Pack |
| 9150-56510 | --- | 9400-52505 | --- | 12 cal/cm ² | --- |
| 9150-56511 | --- | 9400-52501 | --- | 12 cal/cm ² | --- |

ARC FLASH PROTECTION KITS

25 & 33 CAL / 40-100 CAL ARC KITS



25 & 33 CAL ARC KITS

For higher voltage situations, PIP's 25 & 33 cal Arc Flash Kits are designed to meet your PPE 3 needs (insulating glove kits and arc rated hearing protection are not included). The kits come with safety helmet and arc hood in addition to the components needed to be in compliance with the NFPA 70E Standard.

PPE 3 ARC PROTECTION KITS

| ITEM NUMBER | CLOTHING | CLOTHING STYLE NUMBER | FEATURE | HOOD | ARC RATING | STORAGE BAG |
|----------------------------|------------------|-------------------------|-----------------------|----------------------------|------------------------|-------------|
| 9150-52815 | Coverall | 9100-52772 | Aramid Thread & Cuffs | 9150-52515 | 25 cal/cm ² | Carry Bag |
| 9150-52821 | Coverall | 9100-52772 | Aramid Thread & Cuffs | 9150-52515 | 25 cal/cm ² | Back Pack |
| 9150-53003 | Jacket & Overall | 9100-21721 & 9100-21731 | 2-Piece Set | 9150-52515 | 25 cal/cm ² | Carry Bag |
| 9150-53018 | Jacket & Overall | 9100-21721 & 9100-21731 | 2-Piece Set | 9150-52515 | 25 cal/cm ² | Back Pack |
| 9150-52917 | Coverall | 9100-52758 | Aramid Thread & Cuffs | 9150-52685 | 33 cal/cm ² | Carry Bag |
| 9150-52946 | Coverall | 9100-52758 | Aramid Thread & Cuffs | 9150-52685 | 33 cal/cm ² | Back Pack |
| 9150-52609 | Jacket & Overall | 9100-52680 & 9100-53680 | 2-Piece Set | 9150-52685 | 33 cal/cm ² | Carry Bag |
| 9150-21712 | Jacket & Overall | 9100-21780 & 9100-52564 | 2-Piece Set | 9150-52685 | 33 cal/cm ² | Back Pack |



40-100 CAL ARC KITS

Serious protection demands serious products. PIP has worked to develop multiple kits for high risk environments. Together with you, we can help you meet compliance regulations by offering you turn-key kits. (Insulating glove kits and arc rated hearing protection are not included).

PPE 4 ARC PROTECTION KITS

| ITEM NUMBER | CLOTHING | CLOTHING STYLE NUMBER | FEATURE | HOOD | ARC RATING | STORAGE BAG |
|------------------------------|-------------------|---|-------------|-----------------------------|-------------------------|-------------|
| 9150-54VULT | Jacket & Overpant | 9100-524ULT & 9100-530ULT | Ultralight | 9150-5236V | 40 cal/cm ² | Carry Bag |
| 9150-54VULTB | Jacket & Overpant | 9100-524ULT & 9100-530ULT | Ultralight | 9150-5236V | 40 cal/cm ² | Back Pack |
| 9150-540ULT | Jacket & Overpant | 9100-524ULT & 9100-530ULT | Ultralight | 9150-523ULT | 40 cal/cm ² | Carry Bag |
| 9150-540ULTB | Jacket & Overpant | 9100-524ULT & 9100-530ULT | Ultralight | 9150-523ULT | 40 cal/cm ² | Back Pack |
| 9150-52436 | Jacket & Overall | 9100-52412 & 9100-52422 | 2-Piece Set | 9150-52850 | 40 cal/cm ² | Carry Bag |
| 9150-52436B | Jacket & Overall | 9100-52412 & 9100-52422 | 2-Piece Set | 9150-52850 | 40 cal/cm ² | Back Pack |
| 9150-75050 | Jacket & Overall | 9100-75000 & 9100-75001 | 2-Piece Set | 9150-75002 | 75 cal/cm ² | Carry Bag |
| 9150-75050B | Jacket & Overall | 9100-75000 & 9100-75001 | 2-Piece Set | 9150-75002 | 75 cal/cm ² | Back Pack |
| 9150-52730 | Jacket & Overall | 9100-52750 & 9100-53750 | 2-Piece Set | 9150-52689 | 100 cal/cm ² | Carry Bag |
| 9150-52730B | Jacket & Overall | 9100-52750 & 9100-53750 | 2-Piece Set | 9150-52689 | 100 cal/cm ² | Back Pack |

ARC FLASH PROTECTION KITS

40 CAL HYBRID FABRIC ARC KITS

40

CAL/CM²

LIGHTER IS BETTER 37% BETTER

ULTRALIGHT 40 CAL/CM² CLOTHING UTILIZES A HYBRID FABRIC TECHNOLOGY TO INCREASE GARMENT DURABILITY IN THE FIELD WHILE DECREASING ITS WEIGHT BY 37%. OUR ULTRALIGHT GARMENT USES A DUPONT® SHELL TO PROVIDE ITS SUPERIOR TENSILE STRENGTH, INDUSTRIAL WASH RESISTANCE, AND LONG-TERM DURABILITY. MEETS NFPA 70E, ASTM F1506, OSHA 29 CFR 1910.269.

- 40 CAL/CM² HYBRID FABRIC TECHNOLOGY
- SHELL: DUPONT® PROTERA® (FIBER BLEND: 33% NOMEX® AND KEVLAR®, 65% MODACRYLIC, 2% ANTISTATIC)
- INSIDE LAYER: WESTEX® ULTRASOFT® INTERLOCK KNIT (88% COTTON, 12% HIGH TENACITY NYLON)



HYBRID FABRIC TECHNOLOGY

VENTILATING UNIT

VENTILATING UNIT AND POWER PACK ARE PROTECTED BY A COMPACT AND DURABLE ABS CASE COVERED BY ULTRALIGHT FABRIC.

- UNIT WEIGHT: 1 LB (16 OZ.)
- AIRFLOW: 35 CFM

6+ USABLE HOURS OF BATTERY LIFE

40 CAL ULTRALIGHT HOODS, JACKETS & PANTS (NFPA 70E, ASTM F1506)

| ITEM NUMBER | GARMENT | FEATURE | COLOR | ARC RATING | SIZE |
|-----------------------------|----------|------------------------------|-------------------------------|------------------------|--------|
| 9150-5236V | Hood | Ventilated with Battery Pack | <input type="checkbox"/> Navy | 40 cal/cm ² | OSFM |
| 9150-523ULT | Hood | Non-Ventilated | <input type="checkbox"/> Navy | 40 cal/cm ² | OSFM |
| 9100-524ULT | Jacket | Aramid High Tenacity Thread | <input type="checkbox"/> Navy | 40 cal/cm ² | S - 5X |
| 9100-530ULT | Overpant | Aramid High Tenacity Thread | <input type="checkbox"/> Navy | 40 cal/cm ² | S - 5X |

ARC FLASH HEAD GEAR

REPLACEMENT SHIELDS & ACCESSORIES



TRANSPARENT CHIN CUP



USES ACCESSORY SLOTS



UNIVERSAL FIT

ADAPTERS & STORAGE BAGS



ARC PROTECTIVE SHIELDS (NFPA 70E, ASTM F2178, ANSI Z87+S, INCLUDES CHIN CUP)

| ITEM NUMBER | ARC RATING | MATERIAL | FITS | CHIN CUP COLOR | INCLUDES |
|----------------------------|------------------------|---------------|-----------|----------------|---------------------------------|
| 9400-53512 | 12 cal/cm ² | Polycarbonate | Full Brim | Transparent | Mounting Bracket |
| 9400-53520 | 20 cal/cm ² | Polycarbonate | Full Brim | Transparent | Mounting Bracket |
| 9400-53514 | 12 cal/cm ² | Polycarbonate | Cap Style | Transparent | Mounting Bracket |
| 9400-53524 | 20 cal/cm ² | Polycarbonate | Cap Style | Transparent | Mounting Bracket |
| 9400-53502 | 12 cal/cm ² | Polycarbonate | --- | Transparent | Replacement Shield |
| 9400-53504 | 20 cal/cm ² | Polycarbonate | --- | Transparent | Replacement Shield |
| 9400-52505 | 12 cal/cm ² | Polycarbonate | Cap Style | Blue | Clip Mount |
| 9400-52511 | 20 cal/cm ² | Polycarbonate | Cap Style | Blue | Clip Mount |
| 9400-52501 | 12 cal/cm ² | Polycarbonate | Universal | Blue | Elastomeric Hard Hat Attachment |
| 9400-52507 | 20 cal/cm ² | Polycarbonate | Universal | Blue | Elastomeric Hard Hat Attachment |
| 9400-52502 | 12 cal/cm ² | Polycarbonate | --- | Blue | Replacement Shield |
| 9400-52504 | 20 cal/cm ² | Polycarbonate | --- | Blue | Replacement Shield |

ARC PROTECTIVE ACCESSORIES (NFPA 70E, ASTM F2178, ANSI Z87+S)

| ITEM NUMBER | MATERIAL | DESCRIPTION |
|----------------------------|----------|---|
| 9400-52503 | Nylon | Cap Style Hard Hat Adapter |
| 9400-52506 | Nylon | Full Brim Hard Hat Adapter with Elastomeric Band |
| 9400-80016 | Nylon | Universal Hard Hat Adapter with Elastomeric Band |
| 9400-52509 | Cotton | Premium Arc Shield Storage Bag with Pull Cord Closure |
| 9400-52508 | Cotton | Arc Shield Storage Bag with Pull Cord Closure |

Hard hat not included



ARC SHIELDS

ARC FLASH HEAD GEAR

ARC FLASH HOODS



INCORPORATES
UV AND IR ABSORBING
ARC SHIELD LENS
PROVIDING PROTECTION
UP TO 100 CAL/CM²



GREEN TINT WINDOW IS
COATED WITH A PERMANENT
ANTI-FOG INNER SURFACE

ELECTRICAL ARC HOODS (NFPA 70E, ASTM F1506)

| ITEM NUMBER | WEIGHT | LAYERS | MATERIAL | PPE CAT. | ARC RATING | DESCRIPTION |
|--------------------|--------------------------------------|--------|--|----------|-------------------------|-------------------------------------|
| 9150-52548 | 9 oz. | 1 | Cotton / Nylon | 2 | 12 cal/cm ² | Includes Arc Shield, Hard Hat, etc. |
| 9150-52515 | 7 oz. | 2 | Cotton / Nylon | 3 | 25 cal/cm ² | Includes Arc Shield, Hard Hat, etc. |
| 9150-52685 | 9 oz. | 2 | Cotton / Nylon | 3 | 33 cal/cm ² | Includes Arc Shield, Hard Hat, etc. |
| 9150-5236V | 8 oz. / 6 oz. | 2 | Protera [®] / Ultrasoft [®] | 4 | 40 cal/cm ² | Includes Arc Shield, Hard Hat, etc. |
| 9150-523ULT | 8 oz. / 6 oz. | 2 | Protera [®] / Ultrasoft [®] | 4 | 40 cal/cm ² | Includes Arc Shield, Hard Hat, etc. |
| 9150-52850 | 9 oz. / 13 oz. | 2 | Cotton / Nylon | 4 | 40 cal/cm ² | Includes Arc Shield, Hard Hat, etc. |
| 9150-75002 | 13 oz. / 5.5 oz. 13 oz. / 5.5 oz. | 4 | Cotton / Nylon | 4 | 75 cal/cm ² | Includes Arc Shield, Hard Hat, etc. |
| 9150-52689 | --- | Multi | Ultrasoft [®] / High Tenacity Nylon | 4 | 100 cal/cm ² | Includes Arc Shield, Hard Hat, etc. |

ELECTRICAL ARC HOOD REPLACEMENT WINDOWS (NFPA 70E, ASTM F2178, ANSI Z87+S)

| | | | | | | |
|-------------------|---------|-----|---------------|---|-------------------------|-------------------------------|
| 9400-52517 | 6.4 oz. | --- | Polycarbonate | 3 | 25 cal/cm ² | Arc Shield Replacement Window |
| 9400-52686 | 8 oz. | --- | Polycarbonate | 4 | 40 cal/cm ² | Arc Shield Replacement Window |
| 9400-52699 | 9.6 oz. | --- | Polycarbonate | 4 | 100 cal/cm ² | Arc Shield Replacement Window |

ULTRALIGHT

ARC FLASH HOODS

Arc Rating (NFPA)
40 cal/cm²

ARC FLASH ACCESSORIES

HOODS / BAGS / EYEWEAR



◀ **385-FRBL-11-NV**



◀ **9100-HDFR15**



ARC RATED PROTECTION BALACLAVAS

| ITEM NUMBER | COLOR | WEIGHT | LAYERS | MATERIAL | PPE CATEGORY | ARC RATING |
|--|--|---------|--------|--------------------------------|--------------|--------------------------|
| 385-FRBL-11-NV 385-FRBL-11-OR | <input type="checkbox"/> Navy <input type="checkbox"/> Orange | 6.5 oz. | Single | FR Cotton Knit | 2 | 11.8 cal/cm ² |
| 9100-HDFR12 | <input type="checkbox"/> Navy | 8.5 oz. | Single | Pro-C FR Westex® Ultrasoft® | 2 | 12.1 cal/cm ² |
| 9100-HDFR15 | <input type="checkbox"/> Navy | 8.5 oz. | Single | FR Cotton Rib | 2 | 15.1 cal/cm ² |
| 385-HDFR13-NV 385-HDFR13-OR | <input type="checkbox"/> Navy <input type="checkbox"/> Orange | 13 oz. | Double | FR Cotton / Nylon Knit | 3 | 32.4 cal/cm ² |



FOR USE UNDER ARC SHIELDS

BALACLAVAS



▼ **9400-52514**



▼ **9400-52599**

WATER RESISTANT SHELL

ESP KIT STORAGE BAGS

| ITEM NUMBER | COLOR | STYLE | MATERIAL | FEATURE | CLOSURE | SIZE |
|-------------------|---------------------------------|-----------|-----------------|----------------------------|----------------------|--------------------|
| 9400-52514 | <input type="checkbox"/> Orange | Back Pack | 600 D Polyester | Insulating Glove Pocket | Drawcord & Buckle | 20"L x 8"W x 15"H |
| 9400-52599 | <input type="checkbox"/> Orange | Carry Bag | 600 D Polyester | Molded Rubber Bottom | Zipper | 24"L x 10"W x 13"H |



SAFETY GLASSES

REFER TO THE PAGE NUMBERS BELOW FOR MORE INFORMATION

bouton
OPTICAL



▲ **TRANZMISSION**
PAGE 195

▲ **CAPTAIN**
PAGE 187

▲ **Q-VISION**
PAGE 184

UNDERSTANDING RUBBER INSULATING GLOVES

AS ONE OF THE MOST IMPORTANT COMPONENTS OF PPE FOR ELECTRICAL WORKERS, RUBBER INSULATING GLOVES NEED TO BE STRONG, FLEXIBLE, DURABLE, AND, OF COURSE, DIELECTRIC.

STANDARDS & USE

The proper function of rubber insulating gloves is extremely critical, and there are strict requirements outlined by OSHA 29 CFR 1910.137 with regards to their use and in-service care. There are also different classes of gloves available depending on the level of voltage protection they provide (see the table on the following page for this information).

It is critical to inspect your rubber insulating gloves before each day's use and after any action that could be expected to cause damage to the glove. If the gloves show any evidence of damage, they should not be used.

LEATHER PROTECTORS

Leather protectors must be worn over the rubber insulating gloves when working with them. Leather protectors help provide cut, puncture, and abrasion protection for the rubber insulating gloves. The class of the leather protectors needs to match the class of the electrical gloves and leather protectors alone do **not** provide electrical protection.

GLOVE STORAGE BAGS

When they are not in use, rubber insulating gloves should be stored finger tips up in a glove bag and hung – **not laid** – flat. Leather protectors should be removed prior to storage and the rubber insulating gloves should never be folded. The bag should be stored in as dry and cool a place as possible (95°F maximum), away from sources of ozone and direct sunlight.

258 RUBBER INSULATING
GLOVES & SLEEVES

260 LEATHER PROTECTORS

260 ACCESSORIES

RUBBER INSULATING GLOVES

RUBBER INSULATING GLOVES

NOVAX® STRAIGHT CUFF GLOVES

NOVAX® LABELING CHART

| CLASS COLOR | NOVAX® GLOVE LABEL | TEST AC VOLTS | USE AC VOLTS | USE DC VOLTS |
|----------------|--|------------------|-----------------|-----------------|
| CLASS 00 | 10 NOVAX™ by G.B. INDUSTRIES ANSI / ASTM MADE IN D120 CLASS 00 TYPE I MAX USE VOLT 500V AC | 2,500 | 500 | 750 |
| CLASS 0 | 10 NOVAX™ by G.B. INDUSTRIES ANSI / ASTM MADE IN D120 CLASS 0 TYPE I MAX USE VOLT 1000V AC | 5,000 | 1,000 | 1,500 |
| CLASS 1 | 10 NOVAX™ by G.B. INDUSTRIES ANSI / ASTM MADE IN D120 CLASS 1 TYPE I MAX USE VOLT 7500V AC | 10,000 | 7,500 | 11,250 |
| CLASS 2 | 10 NOVAX™ by G.B. INDUSTRIES ANSI / ASTM MADE IN D120 CLASS 2 TYPE I MAX USE VOLT 17000V AC | 20,000 | 17,000 | 25,500 |
| CLASS 3 | 10 NOVAX™ by G.B. INDUSTRIES ANSI / ASTM MADE IN D120 CLASS 3 TYPE I MAX USE VOLT 26500V AC | 30,000 | 25,500 | 39,750 |
| CLASS 4 | 10 NOVAX™ by G.B. INDUSTRIES ANSI / ASTM MADE IN D120 CLASS 4 TYPE I MAX USE VOLT 36000V AC | 40,000 | 36,000 | 54,000 |

NOVAX® STANDARDS SPECIFICATION REFERENCE

| | |
|-----------------------------|--|
| OSHA REGULATIONS | 29CFR part 1910 Occupational Safety and Health Standards |
| ASTM STANDARDS | ASTM D120-14a Rubber Insulating Gloves ASTM F496-14a In-Services Care of Insulating Gloves and Sleeves ASTM F696-06 Leather Protectors for Rubber Insulating Gloves and Mittens ASTM F1236-16 Visual Inspection of Electrical Protective Rubber Products ASTM D1051-14a Rubber Insulating Sleeves |
| NFPA STANDARDS | National Electric Safety Code NFPA 70E Electrical Safety in the Workplace - General Workplaces |

NOVAX
ELECTRICAL SAFETY



STRAIGHT CUFF STYLES

Novax® products exceed all requirements of ASTM D120 & D1051, ensuring compliance with OSHA regulations and satisfying NFPA 70E requirements for protection against electrical shock hazards. The natural rubber construction offers excellent dielectric properties combined with flexibility, strength, and durability. Other features include a contoured shape that reduces hand fatigue and a rolled cuff for increased durability during donning and doffing.

RUBBER INSULATING GLOVES

NOVAX® GLOVES & SLEEVES

NOVAX® RUBBER INSULATING GLOVES STRAIGHT CUFF STYLES

| STYLE NUMBER | CLASS | COLOR | LENGTH | SIZES |
|----------------------------|-------|----------------|--------|--------|
| 150-00-11 | 00 | Black | 11" | 7 - 12 |
| 147-00-11 | 00 | Orange | 11" | 7 - 12 |
| 170-00-11 | 00 | Yellow | 11" | 7 - 12 |
| 153-00-11 | 00 | Red | 11" | 8 - 11 |
| 150-00-14 | 00 | Black | 14" | 7 - 12 |
| 170-00-14 | 00 | Yellow | 14" | 7 - 12 |
| 150-0-11 | 0 | Black | 11" | 7 - 12 |
| 147-0-11 | 0 | Orange | 11" | 7 - 12 |
| 155-0-11 | 0 | Black / Orange | 11" | 7 - 12 |
| 170-0-11 | 0 | Yellow | 11" | 7 - 12 |
| 153-0-11 | 0 | Red | 11" | 8 - 11 |
| 150-0-14 | 0 | Black | 14" | 7 - 12 |
| 170-0-14 | 0 | Yellow | 14" | 7 - 12 |
| 150-1-14 | 1 | Black | 14" | 7 - 12 |
| 147-1-14 | 1 | Orange | 14" | 7 - 12 |
| 155-1-14 | 1 | Black / Orange | 14" | 7 - 12 |
| 153-1-14 | 1 | Red | 14" | 7 - 12 |
| 155-1-16* | 1 | Black / Orange | 16" | 7 - 12 |
| 147-2-14 | 1 | Orange | 14" | 7 - 12 |
| 155-2-14 | 1 | Black / Orange | 14" | 7 - 12 |
| 170-2-14 | 1 | Yellow | 14" | 7 - 12 |
| 150-2-14 | 2 | Black | 14" | 7 - 12 |
| 156-2-14 | 2 | Black / Red | 14" | 9 - 12 |
| 152-2-16 | 2 | Black / Yellow | 16" | 7 - 12 |
| 155-2-16 | 2 | Black / Orange | 16" | 8 - 12 |
| 152-2-18** | 2 | Black / Yellow | 18" | 7 - 12 |
| 155-2-18 | 2 | Black / Orange | 18" | 8 - 12 |
| 150-3-16* | 3 | Black | 16" | 9 - 12 |
| 155-3-16 | 3 | Black / Orange | 16" | 9 - 12 |
| 150-3-18* | 3 | Black | 18" | 9 - 12 |
| 155-3-18 | 3 | Black / Orange | 18" | 9 - 12 |
| 155-4-16 | 4 | Black / Orange | 16" | 9 - 12 |
| 155-4-18 | 4 | Black / Orange | 18" | 9 - 12 |



BELL CUFF

CONTOUR CUFF

BELL CUFF STYLES

| STYLE NUMBER | CLASS | COLOR | LENGTH | SIZES |
|---------------------------|-------|----------------|--------|--------|
| 154-2-16* | 2 | Black / Yellow | 16" | 8 - 12 |
| 159-2-16 | 2 | Black / Orange | 16" | 8 - 12 |
| 161-2-16* | 2 | Black / Red | 16" | 8 - 12 |
| 154-2-18 | 2 | Black / Yellow | 18" | 8 - 12 |
| 159-2-18 | 2 | Black / Orange | 18" | 8 - 12 |
| 161-2-18 | 2 | Black / Red | 18" | 8 - 12 |
| 159-3-16 | 3 | Black / Orange | 16" | 9 - 12 |
| 159-3-18 | 3 | Black / Orange | 18" | 9 - 12 |
| 159-4-16 | 4 | Black / Orange | 16" | 9 - 12 |
| 159-4-18 | 4 | Black / Orange | 18" | 9 - 12 |

CONTOUR CUFF STYLES

| | | | | |
|---------------------------|---|----------------|-----|--------|
| 158-1-18 | 1 | Black / Orange | 18" | 8 - 12 |
| 151-2-18* | 2 | Black / Yellow | 18" | 8 - 12 |
| 158-2-18 | 2 | Black / Orange | 18" | 8 - 12 |
| 162-2-18 | 2 | Black / Red | 18" | 8 - 12 |
| 151-3-18 | 3 | Black / Yellow | 18" | 9 - 12 |
| 158-3-18 | 3 | Black / Orange | 18" | 9 - 12 |
| 158-4-18 | 4 | Black / Orange | 18" | 9 - 12 |



NOVAX® TYPE I RUBBER INSULATING SLEEVES

- Designed to provide extended protection for electrical workers whose arms can potentially come into contact with an energized part
- Meets all requirements of ASTM D1051, ensuring compliance with OSHA regulations
- Superior comfort and flexibility
- Curved shape delivers enhanced ergonomics
- Straps are included with each set

| STYLE NUMBER | CLASS | COLOR | SIZES |
|-------------------------------|-------|----------------|-------------|
| 190-2-REGULAR | 2 | Black | Regular |
| 190-2-LARGE | 2 | Black | Large |
| 190-2-XLARGE | 2 | Black | Extra Large |
| 195-2-REGULAR | 2 | Black / Orange | Regular |
| 195-2-LARGE | 2 | Black / Orange | Large |
| 195-2-XLARGE | 2 | Black / Orange | Extra Large |
| 197-2-REGULAR | 2 | Orange | Regular |
| 197-2-LARGE | 2 | Orange | Large |
| 197-2-XLARGE | 2 | Orange | Extra Large |

*Special-order items

**Half sizes are available for this style (8.5, 9.5, 10.5, 11.5)

RUBBER INSULATING GLOVES

LEATHER PROTECTORS / STORAGE BAGS / INFLATOR / SAFETY KITS

LEATHER PROTECTOR GLOVE COVERS

| STYLE NUMBER | CLASS | MATERIAL | CUFF | LENGTH | SIZES |
|--------------------------|-------|----------|----------|--------|--------|
| 148-1000 | 00-0 | Goatskin | Driver | 10" | 7 - 12 |
| 148-2000 | 00-0 | Goatskin | Gauntlet | 13" | 7 - 12 |
| 148-4000 | 1-2 | Cowhide | Gauntlet | 12" | 8 - 12 |
| 148-5000 | 1-2 | Goatskin | Gauntlet | 12" | 7 - 12 |
| 148-6000 | 1-4 | Goatskin | Gauntlet | 14" | 8 - 12 |
| 148-7000 | 3-4 | Goatskin | Gauntlet | 12" | 9 - 12 |



GLOVE STORAGE BAGS

| STYLE NUMBER | COLOR | MATERIAL | LENGTH |
|--------------------------|-----------|----------|--------|
| 148-2136 | ☐ Black | Nylon | 11" |
| 148-2142 | ☐ Black | Nylon | 14" |
| 148-6011 | ■ Natural | Canvas | 11" |
| 148-6014 | ■ Natural | Canvas | 14" |
| 148-6016 | ■ Natural | Canvas | 16" |
| 148-6018 | ■ Natural | Canvas | 18" |

**KEEP YOUR GLOVES
SAFE AND CLEAN!**

STORE THEM BETWEEN USES



GLOVE INFLATOR

- Used for quick and thorough inspection of insulated rubber gloves
- In compliance with OSHA 1910.137 requiring daily inspection of insulating equipment

ITEM NUMBER

9010-51200



WE MAKE IT EASY FOR YOU



**SAFETY KIT
INCLUDES:**

- 1** PAIR OF RUBBER INSULATING GLOVES
- 1** PAIR OF LEATHER PROTECTOR GLOVE COVERS
- 1** 11" STORAGE BAG FOR GLOVES

Just pick the class that your application requires, the color and size rubber glove that you want, and we do the rest by assembling a kit that works.

ELECTRICAL SAFETY KITS

| STYLE NUMBER | CLASS | COLOR | LENGTH | SIZES |
|---------------------------|-------|------------------|--------|--------|
| 150-SK-00 | 00 | ☐ Black | 11" | 7 - 12 |
| 147-SK-00 | 00 | ■ Orange | 11" | 7 - 12 |
| 150-SK-0 | 0 | ☐ Black | 11" | 7 - 12 |
| 147-SK-0 | 0 | ■ Orange | 11" | 7 - 12 |
| 150-SK-1 | 1 | ☐ Black | 14" | 7 - 12 |
| 147-SK-1 | 1 | ■ Orange | 14" | 7 - 12 |
| 150-SK-2 | 2 | ☐ Black | 14" | 7 - 12 |
| 147-SK-2 | 2 | ■ Orange | 14" | 7 - 12 |
| 155-SK-2 | 2 | ■ Black / Orange | 14" | 7 - 12 |

WHY USE **ERGONOMICS**

WHEN THE WEAR AND TEAR OF THE JOB STARTS TO TAKE ITS TOLL, THERE IS SOMEWHERE TO TURN TO HELP RELIEVE SOME OF THE PRESSURE AND DISCOMFORT ONE ENDURES, ESPECIALLY WHEN PERFORMING REPETITIVE TASKS AND/OR WHEN LIFTING IS INVOLVED. ERGONOMIC PRODUCTS CAN LIMIT DISCOMFORT AND HELP REDUCE STRESS ON THE GIVEN BODY PART THE PRODUCT IS DESIGNED TO HELP.

SLEEVES & SUPPORTS

- **Wrist, elbow, and knee sleeves** can reduce stress, strain, and swelling.
- **Elbow and wrist supports** provide additional reinforcement for those areas.
- **Back supports** support the lumbar area and provide stability for the worker when lifting.

PREVENT & PROTECT

Ergonomics should not only be worn once discomfort or pain is incurred. Using Ergonomic products can proactively help reduce injuries and provide a more comfortable work experience.

By using Ergonomic products, one can continue working more comfortably and productively by significantly reducing the pains and strains incurred from day-to-day work.

262 WRIST & ELBOW SUPPORTS

263 KNEE PADS & SUPPORTS

264 BACK SUPPORTS

ERGONOMICS

REDUCE STRESS & PROVIDE STABILITY



WRIST WRAP



WRIST WRAP WITH THUMB LOOP



WRIST SUPPORT WITH STAYS



NEOPRENE WRIST WRAP



ELBOW SUPPORT WRAP



ELBOW SLEEVE

| | | | | | | |
|----------------------|--|--|--|--|--|--|
| STYLE NUMBERS | 290-9010BLK ■ Black - One Size | 290-9011BLK ■ Black - One Size | 290-9013S ■ Black - 5.375"-6.125" | 290-9015 ■ Black - One Size | 290-9000S ■ Black - 8.5"-10" | 290-9001S ■ Black - 8.5"-10" |
| | 290-9010BGE ■ Beige - One Size | | 290-9013M ■ Black - 6.125"-6.875" | | 290-9000M ■ Black - 10"-11" | 290-9001M ■ Black - 10"-11" |
| | | | 290-9013L ■ Black - 6.875"-7.625" | | 290-9000L ■ Black - 11"-12" | 290-9001L ■ Black - 11"-12" |
| | | | 290-9013XL ■ Black - 7.625"-8.375" | | 290-9000XL ■ Black - 12"-13.5" | 290-9001XL ■ Black - 12"-13.5" |
| KEY FEATURE | Stretchable Elastic Fabric | Thumb Loop Holds Support in Place | Helps Maintain a Neutral Wrist Position | Light Neoprene Body Provides Soothing Warmth | Provides Relief from Stress and Pressure Caused by Repetitive Motion | Provides Therapeutic Warming to Relieve Stress and Comfort Muscles |
| APPLICATIONS | Office / Retail / Light Industrial | Office / Retail / Light Industrial | Office / Retail / Light Industrial | Office / Retail / Light Industrial | Office / Retail / Light Industrial | Office / Retail / Light Industrial |
| FABRIC | Nylon & Spandex | Polyester & Spandex | Neoprene & Nylon | Neoprene & Nylon | Neoprene & Nylon | Neoprene & Nylon |
| THUMB LOOP | No | Yes | Yes | Yes | --- | --- |
| CLOSURE | Hook & Loop | Hook & Loop | Hook & Loop | Hook & Loop | Hook & Loop | Sleeve |
| SUPPORT STAYS | No | No | Top & Bottom | No | --- | --- |
| FIT | Ambidextrous | Ambidextrous | Ambidextrous | Ambidextrous | Ambidextrous | Ambidextrous |
| COLOR | ■ Black or ■ Beige | ■ Black | ■ Black | ■ Black | ■ Black | ■ Black |
| SIZES | OSFM | OSFM | S - XL | OSFM | S - XL | S - XL |
| PACKAGING | 1 per Poly Bag | 1 per Poly Bag | 1 per Poly Bag | 1 per Poly Bag | 1 per Poly Bag | 1 per Poly Bag |

ALL STYLES ON THIS PAGE ARE MACHINE WASHABLE



HARD PLASTIC CAP

NON-MARRING

CLEAR FLAT-CAP GEL

| STYLE NUMBERS | <u>291-100</u> | <u>291-110</u> | <u>291-130</u> |
|------------------|--|---|---|
| KEY FEATURE | Economical with Abrasion Resistance & Great for Pivoting | PVC Cap Won't Mark, Scratch or Scuff Surfaces | Air-Injected Gel Pads are Ideal for Hard Surfaces |
| APPLICATIONS | Industrial / Construction | Industrial / Construction | Industrial / Construction |
| KNEE CAP | Polyethylene | Extended PVC | PVC with Flat Surface |
| ANTI-SLIP RIDGES | No | Yes | Yes |
| CLOSURE | Two Hook & Loop Closure Straps | Two Hook & Loop Closure Straps | One Wide Hook & Loop Closure Strap |
| COLOR | ■ Gray Cap on ■ Black | □ White Cap on ■ Black | □ Clear Cap on ■ Black |
| SIZES | OSFM | OSFM | OSFM |
| PACKAGING | 1 per Poly Bag | 1 per Poly Bag | 1 per Poly Bag |

KNEE SLEEVES

Supports muscles and tissues after suffering minor strains, sprains, injuries and arthritis

- Terry-lined vented neoprene with nylon outer shell
- Additional neoprene panel surrounds patella
- Ambidextrous contour design

| STYLE NUMBER | COLOR | DIMENSIONS |
|--------------------------|---------|------------|
| <u>290-9020S</u> | ■ Black | 13" - 14" |
| <u>290-9020M</u> | ■ Black | 14" - 15" |
| <u>290-9020L</u> | ■ Black | 15" - 17" |
| <u>290-9020XL</u> | ■ Black | 17" - 18" |



BACK SUPPORTS



BLACK MESH

| | | |
|----------------------------|-------------------------------------|-----------|
| KEY FEATURE | Popular & Economic Design | |
| APPLICATIONS | Warehouse / Construction | |
| BELT Material | 9" Wide Nylon Mesh | |
| BACK STAYS | 5 | |
| FASTENER | Hook & Loop Closure on Front Panels | |
| SUSPENDERS | Adjustable & Detachable | |
| PACKAGING | 1 per Poly Bag | |
| STYLE NUMBER | COLOR | SIZE |
| 290-440S | <input type="checkbox"/> Black | 32" - 36" |
| 290-440M | <input type="checkbox"/> Black | 36" - 40" |
| 290-440L | <input type="checkbox"/> Black | 40" - 44" |
| 290-440XL | <input type="checkbox"/> Black | 44" - 48" |
| 290-440XXL | <input type="checkbox"/> Black | 48" - 54" |

HI-VIS LIME YELLOW SOLID

| | | |
|----------------------------|---|-----------|
| KEY FEATURE | Bright Hi-Vis Side Bands & Suspenders | |
| APPLICATIONS | Warehouse / Construction | |
| BELT Material | 8" Wide Nylon Elastic | |
| BACK STAYS | 5 | |
| FASTENER | Hook & Loop Closure on Front Panels | |
| SUSPENDERS | Adjustable & Detachable | |
| PACKAGING | 1 per Poly Bag | |
| STYLE NUMBER | COLOR | SIZE |
| 290-550M | <input type="checkbox"/> Hi-Vis Lime Yellow | 36" - 40" |
| 290-550L | <input type="checkbox"/> Hi-Vis Lime Yellow | 40" - 44" |
| 290-550XL | <input type="checkbox"/> Hi-Vis Lime Yellow | 44" - 48" |
| 290-550XXL | <input type="checkbox"/> Hi-Vis Lime Yellow | 48" - 54" |

REDUCE THE CHANCE OF
COSTLY BACK INJURIES & LOST WORK DAYS

BREATHING HAZARDS



GASES

Substances similar to air in their ability to diffuse or spread freely throughout a container or area. Examples include oxygen, carbon monoxide, carbon dioxide, nitrogen and helium.



FUMES

Created when solid materials vaporize under high heat. Fumes come from operations such as welding, smelting and pouring of molten metal.



VAPORS

Formed when a solid or liquid evaporates. Common examples of vapors are gasoline, paint thinners and degreaser solvents.



PARTICULATES

Solid particles are produced by operations such as grinding, crushing, drilling, blasting, sanding and milling.

266 N95 RESPIRATORS

267 DISPOSABLE NUISANCE & DUST MASKS

268 PERSONAL & CONTRACTOR FIRST AID KITS

269 BLOODBORNE PATHOGENS FIRST AID KITS

270 BURN KIT

RESPIRATORY & FIRST AID



N95 RESPIRATORS

- N95 Masks provide 95% filtration efficiency against airborne particles (not resistant to oil)
- NO STAPLES - cone style features ultrasonic welding of straps on wings
- Adjustable outside aluminum nosepiece (with inside foam padding) provides a proper fit



N95 CONE



N95 CONE WITH EXHALATION VALVE



N95 FLAT FOLDED

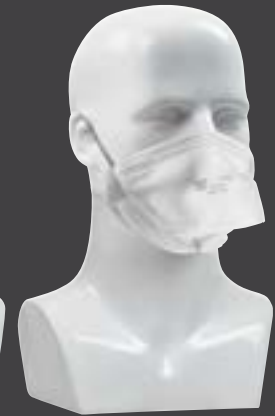

N95 FLAT FOLDED WITH EXHALATION VALVE

| STYLE NUMBERS | 270-2000 | 270-2050 | 270-3000 | 270-3050 |
|------------------|---|---|--|---|
| KEY FEATURE | Flanged Mask Edge For a Better Fit & Seal | Easier Breathing Especially in Hot & Humid Conditions | Fits Inside Pockets, Individually Poly Bagged | Easier Breathing Especially in Hot & Humid Conditions |
| APPLICATIONS | Manufacturing / Construction / Industrial | Manufacturing / Construction / Industrial | Manufacturing / Construction / Industrial | Manufacturing / Construction / Industrial |
| EXHALATION VALVE | No | Yes | No | Yes |
| NOSEPIECE | Adjustable Aluminum | Adjustable Aluminum | Adjustable Aluminum | Adjustable Aluminum |
| HEAD STRAP | Latex-Free Braided | Latex-Free Braided | Latex-Free Rubber | Latex-Free Rubber |
| STRAP ATTACHMENT | Ultrasonic Welded | Ultrasonic Welded | Single Looped Strap | Single Looped Strap |
| APPROVALS | NIOSH Certified | NIOSH Certified | NIOSH Certified | NIOSH Certified |
| PACKAGING | 20 Masks per Box; 12 Boxes per Case | 10 Masks per Box; 12 Boxes per Case | 20 Poly Bagged Masks per Box; 12 Boxes per Case | 10 Poly Bagged Masks per Box; 12 Boxes per Case |

The PIP products in this section of the catalog must be used in accordance with OSHA regulations, user instructions, warnings and limitations accompanying each product.

DISPOSABLE



| | NUISANCE DUST MASK | FACE MASK |
|-------------------------|---|---|
| STYLE NUMBERS | 270-1000 - Standard 270-1101 - Economy | 270-4000 |
| KEY FEATURE | Low Profile Design Allows for Perfect Vision with Safety Glasses or Goggles | 3-Ply Pleated Construction with 99% Bacterial Filter Efficiency (BFE) |
| APPLICATIONS | Manufacturing / General Maintenance / Critical Environment / Food Service | Manufacturing / General Maintenance / Critical Environment |
| NOSE CLIP | Adjustable Aluminum | Adjustable Aluminum |
| HEAD STRAP | Latex-Free Braided Head Strap | Latex-Free Ear Loops |
| STRAP ATTACHMENT | Ultrasonic Welded | Tied Ear Loops |
| PACKAGING | 50 Masks per Box; 12 Boxes per Case | 50 Masks per Box; 40 Boxes per Case |

NUISANCE MASKS & FACE MASKS

FIRST AID KITS

PERSONAL & CONTRACTOR KITS



PERSONAL FIRST AID KIT

STYLE NUMBERS **299-13210** - 10 Person Kit
299-13225 - 25 Person Kit
299-13255 - 50 Person Kit

KEY FEATURE Variety of Different Items to Treat Minor Injuries

APPLICATIONS Job Site / Office / Vehicle

PACKAGING Weatherproof Plastic Box

MOUNT Wall Mountable via Slots in Carrying Handle

CONTRACTOR FIRST AID KIT

STYLE NUMBERS **299-13285** - 10 Person Kit
299-13290 - 25 Person Kit
299-13293 - 50 Person Kit

KEY FEATURE Fewer Items in Bulk Quantities to Treat Minor Injuries

APPLICATIONS Job Site / Office / Vehicle

PACKAGING Weatherproof Plastic Box

MOUNT Wall Mountable via Slots in Carrying Handle

First Aid instructions are shown in both English and Spanish

COMPACT KITS CONTAIN THE SUPPLIES YOU NEED TO TREAT MINOR INJURIES

| STYLE | PERSONAL | | | CONTRACTOR | | |
|-----------------------------|----------|-----|-----|------------|------|-----|
| | 10 | 25 | 50 | 10 | 25 | 50 |
| ABDOMINAL PAD (5" x 9") | 1 | 1 | 1 | 1 | 1 | 1 |
| ALCOHOL PREP PADS | - | 6 | 20* | 20* | 20* | 6 |
| ANTISEPTIC TOWELETTES | 12* | 20* | 20* | - | - | 20* |
| HAND SANITIZER | 1 | 1 | 2 | - | - | - |
| COLD INSTANT PACK (4" x 5") | 1 | 1 | 1 | - | 1 | 1 |
| CONFORMING GAUZE ROLL (2") | - | 1 | 1 | - | 1 | 2 |
| COTTON TIP APPLICATORS (3") | - | - | 12 | - | - | - |
| CPR DEVICE (DISPOSABLE) | - | - | 1 | - | - | - |
| FLEXIBLE FABRIC STRIPS | 6 | 12* | 12* | - | - | 6 |
| OVAL EYE PADS | - | - | 2 | - | - | - |
| EYE WASH (1 OZ.) | - | 1 | 1 | 1 | 1 | 1 |
| FLEXIBLE FABRIC FINGERTIP | 2 | 4 | 12* | - | - | 2 |
| FLEXIBLE FABRIC KNUCKLE | 2 | 4 | 12* | - | - | 2 |
| FIRST AID & BURN CREAM | 8* | 8* | 12* | 8* | 8* | 8* |
| GAUZE PADS (3" x 3") | 4 | 4 | 12 | - | - | 2 |
| MICROBIAL TOWELETTES | 1 | 1 | 3 | - | - | - |
| MEDICAL EXAM GLOVES | 2 | 2 | 4 | 1 | 1 | 2 |
| CLEAR ADHESIVE STRIPS | 16* | 25* | 25* | 16* | 100* | 16* |
| ELASTIC BANDAGE (2") | 1 | 1 | 1 | - | - | 1 |
| ASSORTED SAFETY PINS | 4 | 4 | 8 | - | - | 4 |
| SCISSORS (4") | 1 | 1 | - | 1 | 1 | 1 |
| BANDAGE SCISSORS (5.5") | - | - | 1 | - | - | - |
| SPLINTER FORCEPS | 1 | 1 | 1 | 1 | 1 | 1 |
| SPLINTER OUT | - | 2 | - | - | - | - |
| STING RELIEF PADS | - | 6 | - | - | - | 1 |
| ADHESIVE TAPE (1/2") | 1 | 1 | 1 | 1 | 1 | 1 |
| TRIANGLE BANDAGE | 1 | 1 | 1 | 1 | 1 | 1 |
| CLEANSING TOWELETTES | 6 | 6 | 12 | - | - | - |

* ITEMS ARE BOXED



BLOODBORNE PATHOGENS KIT

| | |
|---------------|---|
| STYLE NUMBER | 299-13215 |
| KEY FEATURE | Biohazard Kit for Bodily Fluid Cleanup |
| APPLICATIONS | Job Site / Office / Vehicle |
| STANDARDS MET | OSHA 1910.103 |
| PACKAGING | Weatherproof Plastic Box |
| MOUNT | Wall Mountable via Slots in Carrying Handle |

SUPPLIES INCLUDED

| | |
|-----------------------------|--------------------------------|
| FACE SHIELD & VISOR | 1 |
| ABSORBENT TOWELS | 3 |
| APRON | 1 |
| ANTI-MICROBIAL TOWELETTE | 1 |
| MEDICAL EXAM GLOVES | 2 |
| BIO SCOOP & SCRAPPER | 1 |
| BIOHAZARD WASTE BAGS | 2 |
| RED SUPER ABSORB FOAM (10G) | 1 |
| ANTISEPTIC TOWELETTES (XL) | 2 |
| INCIDENT REPORT | 1 Exposure Control Report Form |

FIRST AID & BLOODBORNE PATHOGENS KIT

| | |
|---------------|---|
| STYLE NUMBER | 299-17030 |
| KEY FEATURE | A Combination of the First Aid and Bloodborne Pathogens Kit |
| APPLICATIONS | Job Site / Office / Vehicle |
| STANDARDS MET | OSHA 1910.103 |
| PACKAGING | Weatherproof Plastic Box |
| MOUNT | Wall Mountable via Slots in Carrying Handle |



SUPPLIES INCLUDED

| | |
|------------------------|-----------------------|
| ABDOMINAL PAD | 1 (5" x 9" Sterile) |
| ALCOHOL PREP PADS | 20 |
| ANTISEPTIC TOWELETTES | 10 Small |
| INSTANT COLD PACK | 1 |
| CONFORMING GAUZE ROLL | 1 (2") |
| CPR DEVICE | 1 Disposable |
| PLASTIC STRIPS | 16 (1" X 3" Sterile) |
| EYE WASH | 1 (1 oz.) |
| FIRST AID & BURN CREAM | 8 (0.9 g packets) |
| GAUZE PADS | 4 (3" x 3" Sterile) |
| MEDICAL EXAM GLOVES | 2 |
| BANDAGE SCISSORS | 1 (5½") |
| TWEEZERS | 1 Disposable |
| ADHESIVE TAPE | 1 (½") |
| TRIANGULAR BANDAGE | 1 with 2 Safety Pins |
| FIRST AID GUIDE | 1 (English & Spanish) |
| BBP FLUID CLEANUP KIT | 1 |
| BBP PPE BIOHAZARD KIT | 1 |

First Aid instructions are shown in both English and Spanish

FIRST AID KITS

BURN KIT

EXCELLENT FOR TREATING BURNS ON THE JOBSITE



BURN KIT

| | |
|--------------|---|
| STYLE NUMBER | 299-13295 |
| KEY FEATURE | Basic Necessities for Burn Care |
| APPLICATIONS | Job Site / Office / Vehicle |
| PACKAGING | Weatherproof Plastic Box |
| MOUNT | Wall Mountable via Slots in Carrying Handle |

SUPPLIES INCLUDED

| | |
|-----------------------|----------------|
| STERILE BURN DRESSING | 1 (4" x 4") |
| STERILE BURN DRESSING | 2 (8" x 8") |
| CO-WRAP | 1 (2" x 5 yds) |
| MEDICAL EXAM GLOVES | 2 |
| SCISSORS | 1 (4") |

First Aid instructions are shown in both English and Spanish

UNDERSTANDING SAFETY & EMERGENCY BEACONS

WARNING BEACONS ARE DESIGNED TO PROVIDE INSTANT VISIBILITY WHERE NEEDED, CALLING ATTENTION TO ANYONE IN THEIR VICINITY.

Their design and brightness combined with the different colors and accessory items make warning beacons infinitely versatile. They can be used to draw attention to road closures, obstructions, spills, or loading/unloading zones and help reduce potentially serious and otherwise avoidable injuries.

LIGHT BEAM PROFILE

Beacons are designed to deliver the most intense part of the light beam in a range of 0-5° above horizontal, with a peak near 3°. Due to this beam profile, these beacons will not dazzle or impede the vision of users at short range unless it's positioned at eye level.

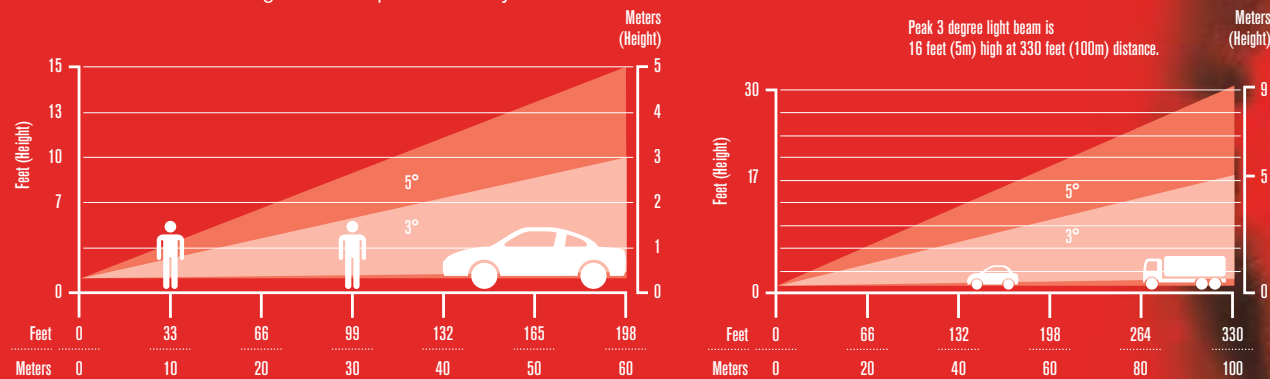

WHY USE WARNING BEACONS OVER CONVENTIONAL FLARES?

Conventional Flares are often pyrotechnic, which require an open flame to operate. This is inherently dangerous and limits areas where they can be used. Most flares also include mixtures that can create toxic fumes and residue.

Incandescent and Strobe Lights can cause night vision, point fixation, and distance judgment issues, especially with impaired or sleep-deprived drivers.

Warning Beacons featured in this section utilize LED technology to produce an intensely bright display and project at an angle that will not dazzle or impede the vision of drivers. Standalone units and units compatible with safety triangles are available.

SAFETY & EMERGENCY BEACONS

272 E-FLARE™ BEACONS

274 FLASH BATONS

SAFETY & EMERGENCY BEACONS

E-FLARE™

E-FLARE™ WARNING BEACONS

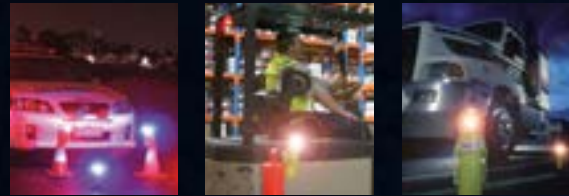

INTENSELY BRIGHT

Can be seen for up to 3/4 of a mile and features full 360° illumination. Angle and beam projection minimizes the risk of target fixation and distance judgment problems associated with strobe and incandescent lights.

LIGHTWEIGHT & EASY TO USE

Beacon weighs less than 10 ounces with four "AA" batteries installed. Improved activation enables a simple twist of the lens to the desired function.

SAFER & BETTER FOR THE ENVIRONMENT

Unlike pyrotechnic flares, there is no risk of fire or explosion, and no toxic fumes or residues.

DURABLE

E-Flare™ beacons can survive up to a 3-foot drop onto a concrete surface. They are also dust-proof and water resistant (up to a depth of 100 ft.).

INFINITELY VERSATILE

Body molded clips with added holes easily attach to belts and clothing. Base accessories are available for heavy-duty mounted applications

HAZMAT accredited for use in Class 1, Division 2 / Zone 2 hazardous areas.

Patented Fresnel lens and high-luminosity LEDs allow beam to be visible for 3/4 mile

Shatterproof polycarbonate lens

Colored pins indicate beacon light colors

Reflective strip and fluorescent body for maximum visibility

High-strength clips with added holes for versatility of attachment

Impact resistant ABS body

Compact and lightweight, weighs under 10 oz. with 4 "AA" batteries



IDEAL FOR POLICE, FIRE, UTILITIES, RAIL & PORT, WAREHOUSE & FACTORY

E-FLARE™ SAFETY & EMERGENCY BEACONS

| STYLE NUMBER | BEACON COLOR | LIGHT INTENSITY | OPERATION | FLASH RATE | BATTERIES | HEIGHT | WEIGHT |
|-------------------------------|---------------|-----------------|----------------------------|-------------|--------------------|--------|------------------------|
| 939-AT290-R | Red | 8 LED | Flash or Steady-On 1-Color | 165-185 fpm | Four "AA" Alkaline | 8" | 9.6 oz. with Batteries |
| 939-AT290-A | Amber | 8 LED | Flash or Steady-On 1-Color | 165-185 fpm | Four "AA" Alkaline | 8" | 9.6 oz. with Batteries |
| 939-AT290-B | Blue | 8 LED | Flash or Steady-On 1-Color | 165-185 fpm | Four "AA" Alkaline | 8" | 9.6 oz. with Batteries |
| 939-AT290-G | Green | 8 LED | Flash or Steady-On 1-Color | 165-185 fpm | Four "AA" Alkaline | 8" | 9.6 oz. with Batteries |
| 939-AT290-W | White | 8 LED | Flash or Steady-On 1-Color | 165-185 fpm | Four "AA" Alkaline | 8" | 9.6 oz. with Batteries |
| 939-AT293-R/B | Red & Blue | 4 + 4 LED | Dual Flash 2-Color | 165-185 fpm | Four "AA" Alkaline | 8" | 9.6 oz. with Batteries |
| 939-AT293-A/W | Amber & White | 4 + 4 LED | Dual Flash 2-Color | 165-185 fpm | Four "AA" Alkaline | 8" | 9.6 oz. with Batteries |
| 939-AT293-B/W | Blue & White | 4 + 4 LED | Dual Flash 2-Color | 165-185 fpm | Four "AA" Alkaline | 8" | 9.6 oz. with Batteries |
| 939-AT293-R/A | Red & Amber | 4 + 4 LED | Dual Flash 2-Color | 165-185 fpm | Four "AA" Alkaline | 8" | 9.6 oz. with Batteries |
| 939-AT293-R/W | Red & White | 4 + 4 LED | Dual Flash 2-Color | 165-185 fpm | Four "AA" Alkaline | 8" | 9.6 oz. with Batteries |

Batteries not included

COMPACT E-FLARE™ ONLY 6" HIGH



▲ 939-AT280-A

▲ 939-EF350-R

E-FLARE™ COMPACT SAFETY & EMERGENCY BEACONS

| STYLE NUMBER | BEACON COLOR | LIGHT INTENSITY | OPERATION | FLASH RATE | BATTERIES | HEIGHT | WEIGHT |
|--------------------|--------------|-----------------|----------------------------|-------------|--------------------|--------|------------------------|
| 939-AT280-R | Red | 8 LED | Flash or Steady-On 1-Color | 165-185 fpm | Four "AA" Alkaline | 6" | 6.4 oz. with Batteries |
| 939-AT280-A | Amber | 8 LED | Flash or Steady-On 1-Color | 165-185 fpm | Four "AA" Alkaline | 6" | 6.4 oz. with Batteries |
| 939-EF350-R | Red | 4 LED | Flash 1-Color | 165-185 fpm | Four "AA" Alkaline | 6" | 6.4 oz. with Batteries |
| 939-EF350-A | Amber | 4 LED | Flash 1-Color | 165-185 fpm | Four "AA" Alkaline | 6" | 6.4 oz. with Batteries |

Batteries not included



RUBBER BASE MOUNT 939-EFBASE

- General purpose base fits all E-Flare™ beacons



AVIATION RUBBER BASE MOUNT 939-EFAVBASE

- Secure base for special purposes that fits all beacons



MAGNETIC BASE MOUNT 939-EFMAGBASE

- Combined magnetic base and cap
- Rated to 50 MPH when securely mounted on vehicle
- Fits all E-Flare™ beacons



MAGNETIC MOUNTING CLIP 939-EFMAGCLIP

- For stationary objects (not for moving vehicles)
- Attaches to any E-Flare™ beacon

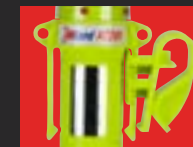

CONE MOUNTING CLIP 939-EFCLIP

- Enables vertical positioning on most types of cones
- Attaches to any E-Flare™ beacon



FLOTATION COLLAR 939-EFFCOL/L

- Provides reliable self-righting buoyancy for marine use
- Includes lanyard
- Attaches to 8" tall E-Flare™ beacons only



STORAGE BAG - SMALL 939-EFBAG-2

- Carry bag for 2 to 3 beacons plus accessories



STORAGE BAG - LARGE 939-EFBAG-4

- Carry bag for 4 to 6 beacons plus accessories

e flare™ BE SEEN. BE SAFE.
safety in a flash



MAGNETIC CAP BASE

E-FLARE™ BEACON FOR RAILROAD SAFETY

- Blue flashing beacon
- 6" High and 0.6 lbs with 4 "AA" batteries
- Built-in magnetic cap base and flashlight
- Includes lanyard for easy transport

| STYLE NUMBER | BEACON COLOR | LIGHT INTENSITY | OPERATION |
|------------------------|--------------|-----------------|----------------------|
| 939-TF250-B-ASY | Blue | 4 LED | Flash 1-Color |
| | White | 3 LED | Steady-On Flashlight |

Batteries not included



Orange triangle not included

E-FLARE™ BEACON FOR SAFETY TRIANGLE

- Maximize the safety of the road triangle
- Visible for over 1/2 mile at night
- Runs on a single "AA" battery for 20+ hours
- Mounts inside most road triangles at 4" in height

| STYLE NUMBER | BEACON COLOR | LIGHT INTENSITY | OPERATION |
|-------------------|--------------|-----------------|---------------|
| 939-TB10-R | Red | 3 LED | Flash 1-Color |

Batteries not included

BATONS

FLASH BATONS

ECONOMICAL BATTERY OPERATED BATON

USES BRIGHT LED'S TO IDENTIFY HAZARDOUS CONDITIONS OR DANGEROUS AREAS

▲ 935-004



▲ 935-006B

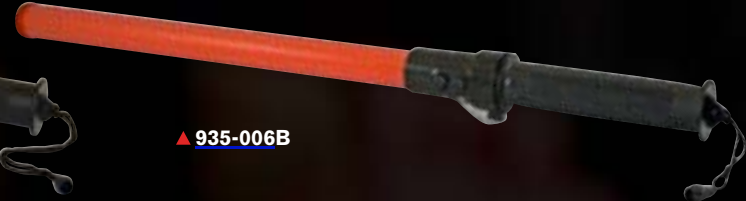

FLASH BATON

| STYLE NUMBER | BATON COLOR | LIGHT INTENSITY | OPERATION | BATTERIES | LENGTH | DIAMETER | PACKAGING |
|--|-------------|-----------------|---|-----------|--------|----------|--------------------|
| 935-004 | Red | 4 LED | Flash, Steady-On, Off | Two "C" | 16" | 1.25" | Individually Boxed |
| FLASH BATON WITH AUDIBLE SIGNAL | | | | | | | |
| 935-006B | Red | 6 LED | Flash, Steady-On, Off Audible Alarm Button (approximately 110 dB) | Three "C" | 22" | 1.25" | Individually Boxed |

Batteries not included

Note: All Batons include carrying strap & attachment clip

BATONS

IDEAL FOR POLICE, FIREFIGHTERS, AIRPORT WORKERS, TRAFFIC CONTROLLERS, PARKING VALETS, CONSTRUCTION WORKERS AND OTHER PUBLIC SAFETY PERSONNEL

HEAT STRESS IS 100% PREVENTABLE

EACH YEAR, MILLIONS OF WORKERS ARE EXPOSED TO POTENTIAL HEAT STRESS. INJURIES RELATED TO HEAT STRESS RANGE FROM DIZZINESS TO DEATH. WITH PROPER EDUCATION, TRAINING, AND COOLING PRODUCTS, HEAT STRESS RELATED INJURIES CAN BE AVOIDED.

COOLING TECHNOLOGIES



PHASE CHANGE

Cold temperature is absorbed by the **Phase Change** material, changing it from a clear liquid to an opaque solid as it is activated.

To use, place the activated phase change pack in the torso garment and wear it against body. The cold temperature begins to be transferred to the wearer as the latent heat is absorbed by the Phase Change material. The material begins to turn back to a clear liquid as it deactivates. Reactivate as needed.

ACTIVATION & USE

PIP's Heat Stress line ranges from premium products that will last your workers through multiple seasons to more economical solutions that are meant for single-use. The activation time is included with each product.



EVAPORATIVE

To activate **Evaporative** cooling products, water is first absorbed by the product's cooling fibers or polymers. Cooling occurs when the moisture within the unit evaporates, creating a cooling sensation for the wearer. When activating, you may use room temperature water. The products must be exposed to air movement to facilitate cooling, and are meant for use over other PPE garments.



ABSORPTIVE

Absorptive materials help to keep the sweat and the sting out of workers' eyes while trapping and moving sweat for a safer, more comfortable job with fewer distractions.



SUN PROTECTION

PIP's **Sun Protection** products include hats and visors with neck shades that will help to screen workers from the sun, to alleviate the toll it takes on productivity, skin and the ability to keep hydrated.

276 PHASE CHANGE

276 EVAPORATIVE

280 ABSORPTIVE

280 SUN PROTECTION

HEAT STRESS

HEAT STRESS

PHASE CHANGE & EVAPORATIVE



PHASE CHANGE
COOLING TECHNOLOGY

WEAR UNDER
OTHER PPE GARMENTS



▼ **390-EZSPC**

▼ **390-EZFRPC**

45
MINUTES

FR OUTER SHELL



▲ **390-PCVCP1**

▲ **390-PCVKT1**



REPLACEMENT PACKS

▲ **390-PC099**



▼ **390-EZ150**

MACHINE WASHABLE

WEAR UNDER
OTHER PPE
GARMENTS

1-2
MINUTES

WEAR OVER
OTHER PPE
GARMENTS



▲ **390-10**



EVAPORATIVE
COOLING TECHNOLOGY



▼ **390-EZ202**



▼ **390-EZ100**

COOLING VESTS

| STYLE NUMBER | COOLING TYPE | DESCRIPTION | ACTIVATION TIME | OUTER FABRIC | INNER FABRIC | WEIGHT | CLOSURE | COLOR | SIZE |
|-------------------|--------------|---|-----------------|-------------------|-----------------------|----------|---|----------------------|--|
| 390-EZSPC | Phase Change | Active Fit Vest with Rechargeable Cooling Packs & Insulated Cooler Bag | 45 Minutes | 100% Cotton | Nylon | 6.0 lbs | Zipper with Side & Shoulder Adjustments | Blue | M/L 100-175 lbs, L/XL 175-250 lbs, 2X/3X 250-300 lbs |
| 390-EZFRPC | Phase Change | Active Fit FR Vest with Rechargeable Cooling Packs & Insulated Cooler Bag | 45 Minutes | Banwear FR Cotton | 100% Cotton | 6.0 lbs | Zipper with Side & Shoulder Adjustments | Navy | M/L 100-175 lbs, L/XL 175-250 lbs, 2X/3X 250-300 lbs |
| 390-PC099 | Phase Change | Reusable Phase Change Pack Set for Slim Fit Design | 45 Minutes | PU | TechKewl™ | 5.0 lbs | --- | Clear | --- |
| 390-PCVKT1 | Phase Change | Vest with Rechargeable Cooling Packs that Fit Inside a Vest | 45 Minutes | Polyester | Nylon | 6.5 lbs | Pullover with Side & Shoulder Adjustments | Navy | One Size |
| 390-PCVCP1 | Phase Change | Reusable Phase Change Pack Set for Classic Design | 45 Minutes | PU | Alkane Blend | 5.5 lbs | --- | Clear | --- |
| 390-EZ100 | Evaporative | Lightweight Cooling Vest | 1-2 Minutes | Polyester / Nylon | HyperKewl™ | 1.5 lbs | Zipper | Hi-Vis Lime Yellow | S - 3X |
| 390-EZ150 | Evaporative | Cooling Tank Top | 1-2 Minutes | Spandex / Nylon | HyperKewl™ Plus | 0.75 lbs | Zipper | Black with Blue Trim | S - 3X |
| 390-EZ202 | Evaporative | ANSI 107 Type R Class 2 Cooling Vest with 4 Pockets | 1-2 Minutes | Polyester / Nylon | HyperKewl™ | 1.5 lbs | Hook & Loop | Hi-Vis Lime Yellow | S/M, L/XL, 2X/3X, 4X/5X |
| 390-10 | Evaporative | High Tech Cooling Vest, No Wetness-Body & Clothing Stay Dry | 30 seconds | Polyester | Engineered Polyfleece | 0.5 lbs | Hook & Loop | Navy | S - 3X |

HEAT STRESS

EVAPORATIVE



EZ-COOL® COOLING NECK WRAP

| | |
|------------------|--------------------|
| COOLING TYPE | Evaporative |
| ACTIVATION TIME | 30 Seconds |
| OUTER | PVA |
| SIZE | 4" x 30" |
| STYLE NUMBER | COLOR |
| 393-650-B | Blue |
| 393-650-L | Hi-Vis Lime Yellow |
| 393-650-P | Pink |



UV PROTECTION

EZ-COOL® MAX COOLING TOWEL

| | |
|---------------------|--------------------------------|
| COOLING TYPE | Evaporative |
| ACTIVATION TIME | 30 Seconds |
| OUTER | Nylon Hollow Fiber / Polyester |
| SIZE | 12" x 33" |
| STYLE NUMBER | COLOR |
| 396-EZ900-NV | Blue |
| 396-EZ900-LY | Hi-Vis Lime Yellow |
| 396-EZ900-PK | Pink |
| 396-EZ900-GC | Digital Camo |



EVAPORATIVE COOLING TECHNOLOGY

SUPER ABSORBENT & SUPER COOL



EZ-COOL® COOLING TOWEL

| | |
|------------------|--------------------|
| COOLING TYPE | Evaporative |
| ACTIVATION TIME | 30 Seconds |
| OUTER | PVA |
| SIZE | 13" x 31" |
| STYLE NUMBER | COLOR |
| 396-602-B | Blue |
| 396-602-L | Hi-Vis Lime Yellow |
| 396-602-P | Pink |



393-EZ201-PAT



393-100-DGC

EZ-COOL® COOLING BANDANA

| | |
|----------------------|----------------------|
| COOLING TYPE | Evaporative |
| ACTIVATION TIME | 1-2 Minutes |
| OUTER | Polyester Mesh |
| INNER | HyperKewl™ |
| CLOSURE | Tie / Breakaway Snap |
| STYLE NUMBER | COLOR |
| 393-EZ201-NVY | Navy |
| 393-EZ201-KHK | Khaki |
| 393-EZ201-PAT | Patriotic Flag |
| 393-EZ201-RTC | REALTREE® Max5® Camo |

VALUE COOLING BANDANA

| | |
|---------------------|------------------|
| COOLING TYPE | Evaporative |
| ACTIVATION TIME | 20-30 Minutes |
| OUTER | Poly Cotton |
| INNER | Cooling Crystals |
| CLOSURE | Tie |
| STYLE NUMBER | COLOR |
| 393-100-BLU | Blue |
| 393-100-CBL | Cowboy Blue |
| 393-100-CRD | Cowboy Red |
| 393-100-DGC | Digital Camo |
| 393-100-KHK | Khaki |
| 393-100-NAVY | Navy |
| 393-100-PAT | Patriotic Flag |

EXTENDED COOLING COMFORT



EZ-COOL® COOLING TIE HAT

| | | |
|----------------------|---|--|
| COOLING TYPE | Evaporative | |
| ACTIVATION TIME | 1-2 Minutes | |
| OUTER | Polyester Mesh | |
| INNER | HyperKewl™ | |
| CLOSURE | Tie | |
| STYLE NUMBER | COLOR | |
| 396-EZ205 | <input type="checkbox"/> Blue | |
| 396-EZ205-RTC | <input type="checkbox"/> REALTREE® Max5® Camo | |



EZ-COOL® COOLING RANGER HAT WITH NECK SHADE

| | | |
|----------------------|---|------------------|
| COOLING TYPE | Evaporative | |
| ACTIVATION TIME | 1-2 Minutes | |
| OUTER | Cotton | |
| INNER | HyperKewl™ | |
| CLOSURE | Drawstring | |
| STYLE NUMBER | COLOR | SIZE |
| 396-EZ450-KHK | <input type="checkbox"/> Khaki | S/M, L/XL, 2X/3X |
| 396-EZ450-RTC | <input type="checkbox"/> REALTREE® Max5® Camo | S/M, L/XL, 2X/3X |
| 396-EZ450-LY | <input type="checkbox"/> Hi-Vis Lime Yellow | S/M, L/XL, 2X/3X |



VALUE COOLING TIE HAT

| | | |
|--------------------|---|--|
| COOLING TYPE | Evaporative | |
| ACTIVATION TIME | 20-30 Minutes | |
| OUTER | Poly Cotton | |
| INNER | Cooling Crystals | |
| CLOSURE | Tie | |
| STYLE NUMBER | COLOR | |
| 396-300-NAV | <input type="checkbox"/> Navy | |
| 396-300-CBL | <input type="checkbox"/> Cowboy Blue | |
| 396-300-PAT | <input type="checkbox"/> Patriotic Flag | |



VALUE COOLING RANGER HAT WITH NECK SHADE

| | | |
|--------------------|--------------------------------|--------|
| COOLING TYPE | Evaporative | |
| ACTIVATION TIME | 20-30 Minutes | |
| OUTER | Poly Cotton | |
| INNER | Cooling Crystals | |
| CLOSURE | Hook & Loop | |
| STYLE NUMBER | COLOR | SIZE |
| 396-425-KHK | <input type="checkbox"/> Khaki | M - XL |

NOTE: RECOMMENDED TO SIZE UP - MAY RUN SMALL



EVAPORATIVE
COOLING TECHNOLOGY



EVAPORATIVE
COOLING TECHNOLOGY



**EZ-COOL® COOLING
HARD HAT NECK SHADE**

| | |
|------------------|---------------|
| COOLING TYPE | Evaporative |
| ACTIVATION TIME | 1-2 Minutes |
| OUTER | Polyester |
| INNER | HyperKewl™ |
| CLOSURE | Hook & Loop |
| STYLE NUMBER | HI-VIS COLOR |
| 396-EZ810 | ■ Lime Yellow |



**EZ-COOL® COOLING FR
HARD HAT NECK SHADE**

| | |
|--------------------|-----------------|
| COOLING TYPE | Evaporative |
| ACTIVATION TIME | 1-2 Minutes |
| OUTER | FR Cotton Banox |
| INNER | HyperKewl™ |
| CLOSURE | Hook & Loop |
| STYLE NUMBER | COLOR |
| 396-EZ811FR | ■ Navy |



**VALUE COOLING
HARD HAT PAD WITH NECK SHADE**

| | |
|-----------------|------------------|
| COOLING TYPE | Evaporative |
| ACTIVATION TIME | 20-30 Minutes |
| OUTER | Poly Cotton |
| INNER | Cooling Crystals |
| CLOSURE | Hook & Loop |
| STYLE NUMBER | COLOR |
| 396-405 | ■ Blue |



**VALUE COOLING
HARD HAT PAD**

| | |
|--------------------|------------------|
| COOLING TYPE | Evaporative |
| ACTIVATION TIME | 20-30 Minutes |
| OUTER | Poly Cotton |
| INNER | Cooling Crystals |
| CLOSURE | Hook & Loop |
| STYLE NUMBER | COLOR |
| 396-400-BLU | ■ Blue |

COOLING COMFORT UNDER HARD HATS

HEAT STRESS

ABSORPTIVE & SUN PROTECTION

KEEPING COOL: NO SWEAT



ABSORPTIVE COOLING TECHNOLOGY

HARD HAT TERRY SWEATBAND

| | |
|----------------------|--------------------|
| COOLING TYPE | Absorptive |
| OUTER | Cotton Terry Cloth |
| CLOSURE | Snaps |
| STYLE NUMBER | COLOR |
| 396-20870-NAV | ■ Navy |
| 396-20870-BGE | ■ Beige |



DISPOSABLE SWEATBANDS

| STYLE NUMBER | COLOR | COOLING TYPE | OUTER | CLOSURE |
|----------------|--------|--------------|--------------------------|---------|
| 396-500 | ■ Blue | Absorptive | 100% Cellulose | Elastic |
| 396-505 | ■ Teal | Absorptive | 100% Polyester Non-Woven | Elastic |



▲ **396-800-LY**

▲ **396-801FR-LY**

SOLID POLYESTER

MESH POLYESTER

HARD HAT VISOR WITH NECK SHADE

| | | |
|------------------|--|----------|
| COOLING TYPE | Shading | |
| OUTER | ANSI Compliant Polyester Hi-Vis with Reflective Tape | |
| CLOSURE | Elastic | |
| STYLE NUMBER | HI-VIS COLOR | MATERIAL |
| 396-800 | ■ Lime Yellow | Solid |
| 396-801FR | ■ Lime Yellow | Mesh |



SUN PROTECTION COOLING TECHNOLOGY

BLOCK HARMFUL SUN RAYS



FR TREATED HI-VIS HARD HAT NECK SHADE

| | | |
|---------------------|--|--|
| COOLING TYPE | Shading | |
| OUTER | ANSI Compliant Polyester Hi-Vis with Reflective Tape | |
| CLOSURE | Elastic | |
| STYLE NUMBER | HI-VIS COLOR | |
| 396-700FR-LY | ■ Lime Yellow | |
| 396-700FR-OR | ■ Orange | |



HI VISIBILITY RANGER HAT

| | | |
|-------------------|--|--|
| COOLING TYPE | Shading | |
| OUTER | ANSI Compliant Polyester Hi-Vis with Reflective Tape | |
| CLOSURE | Drawstring | |
| STYLE NUMBER | HI-VIS COLOR | |
| 350-RANGER | ■ Lime Yellow | |

| ITEM NUMBER | PAGE NUMBER |
|-----------------------------|-------------|
| 07-K200 | 54 |
| 07-K259 | 54 |
| 07-K300 | 54 |
| 07-K320 | 54 |
| 07-K350 | 53 |
| 07-K390 | 49 |
| 07-KA700 | 51 |
| 07-KA710 | 51 |
| 07-KA720 | 49 |
| 07-KA730 | 49 |
| 07-KA740 | 51 |
| 07-KA744 | 53 |
| 08-K200PD | 54 |
| 08-K200PDD | 54 |
| 08-K252 | 54 |
| 08-K259PDD | 54 |
| 08-K300PD | 54 |
| 08-K300PDD | 54 |
| 08-K300PS | 54 |
| 08-K300XC | 54 |
| 08-K312 | 54 |
| 08-K350PDD | 53 |
| 08-K385 | 49 |
| 08-K412PDD | 53 |
| 08-KA700PD | 49 |
| 08-KA700PDD | 49 |
| 08-KA720PD | 49 |
| 08-KA720PDD | 49 |
| 08-KA728PD | 49 |
| 08-KA728PDD | 49 |
| 08-KA740PD | 51 |
| 08-KA740PDD | 51 |
| 08-KA740RT | 51 |
| 08-KA744PD | 53 |
| 08-KA744PDD | 53 |
| 08-KA750PD | 51 |
| 08-KA750PDD | 51 |
| 09-K1218 | 35 |
| 09-K1250 | 42 |
| 09-K1300 | 29 |
| 09-K1310 | 35 |
| 09-K1350 | 35, 120 |
| 09-K1400 | 42 |
| 09-K1450 | 28 |

| ITEM NUMBER | PAGE NUMBER |
|------------------------------------|-------------|
| 09-K1444 | 35 |
| 09-K1450 | 42 |
| 09-K1600 | 29 |
| 09-K1618 | 35 |
| 09-K1630 | 29 |
| 09-K1640 | 29 |
| 09-K1660 | 42 |
| 09-K1700 | 29 |
| 09-K300LP | 51 |
| 09-K3700 | 117 |
| 09-K3700 | 54 |
| 09-K3720 | 54, 117 |
| 09-K3750 | 54, 118 |
| 10-21ACPCB18TH | 133 |
| 10-21HACPNY18-ET | 133 |
| 10-21KVACPM18-ET | 133 |
| 10-21KVACPMBK18-ET | 133 |
| 10-21KVHACP18TH | 133 |
| 10-4IK157 | 143 |
| 10-BKDS18 | 137 |
| 10-BKS18 | 137 |
| 10-K4622 | 145 |
| 10-K4626 | 145 |
| 10-K4722 | 143 |
| 10-K4726 | 143 |
| 10-K4826 | 143 |
| 10-KA18 | 135 |
| 10-KA18CL | 135 |
| 10-KA18KL | 135 |
| 10-KA18S | 135 |
| 10-KA24SCTOT | 135 |
| 10-KAM18 | 145 |
| 10-KAN018 | 135 |
| 10-KAN018CL | 135 |
| 10-KAN018KL | 135 |
| 10-KAN018S | 135 |
| 10-KANP18 | 135 |
| 10-KANP18CL | 135 |
| 10-KANP18KL | 135 |
| 10-KANP18S | 135 |
| 10-KANY18 | 135 |
| 10-KANY18CL | 135 |
| 10-KANY18KL | 135 |
| 10-KANY18S | 135 |

| ITEM NUMBER | PAGE NUMBER |
|----------------------------------|-------------|
| 10-KS18 | 137 |
| 10-KS18CL | 137 |
| 10-KS18S | 137 |
| 10-KSB18 | 143 |
| 10-KVS18DGH | 143 |
| 10-KVS18RD | 143 |
| 10-KVS18YBH | 143 |
| 10-KVSDGH | 29 |
| 10-KVSRD | 29 |
| 10-KVSYBH | 29 |
| 11-45153 | 145 |
| 11-45182 | 145 |
| 11-45183 | 145 |
| 14-ASP700 | 51 |
| 14-ASP700PDD | 51 |
| 14-PK700 | 51 |
| 15-210 | 25 |
| 15-215 | 25 |
| 15-218BKL | 140 |
| 15-218BKS | 140 |
| 15-218NOL | 140 |
| 15-218NOS | 140 |
| 15-218NPL | 140 |
| 15-218NPS | 140 |
| 15-218NPL | 140 |
| 15-218NYS | 140 |
| 15-218WL | 140 |
| 15-218WS | 140 |
| 15-21KVBK18 | 133 |
| 15-21KVBK18TH | 133 |
| 15-21PRI18BL | 140 |
| 15-21PRI18KVBL | 140 |
| 15-21PRI18WL | 140 |
| 15-21PRIBPS18-ET | 133 |
| 15-21PRIWPS18-ET | 133 |
| 15-340 | 25 |
| 15-440 | 25 |
| 16-150 | 41 |
| 16-318V | 41 |
| 16-323 | 39 |
| 16-330 | 39 |
| 16-334 | 39 |
| 16-340LG | 34 |
| 16-3400R | 34 |

| ITEM NUMBER | PAGE NUMBER |
|---------------------------|-------------|
| 16-343LG | 39 |
| 16-3430R | 39 |
| 16-350 | 34 |
| 16-355 | 39 |
| 16-520HY | 34 |
| 16-530 | 41 |
| 16-560 | 27 |
| 16-747 | 34 |
| 16-813 | 39 |
| 16-815 | 34 |
| 16-820 | 34 |
| 16-D622 | 41 |
| 16-X310 | 23 |
| 16-X320 | 23 |
| 16-X540 | 23 |
| 16-X570 | 23 |
| 16-X575 | 23 |
| 17-D200 | 54 |
| 17-D300 | 54 |
| 17-D350 | 53 |
| 17-DA700 | 51 |
| 17-DA720 | 51 |
| 17-DL200 | 54 |
| 17-DL300 | 53 |
| 17-SD200 | 54 |
| 17-SD300 | 54 |
| 17-SD350 | 53 |
| 18-570 | 43 |
| 18-575 | 43 |
| 18-SD385 | 49 |
| 19-D310 | 33 |
| 19-D313 | 27 |
| 19-D315 | 27 |
| 19-D318 | 38 |
| 19-D320 | 33 |
| 19-D322 | 33 |
| 19-D324 | 38 |
| 19-D325 | 33 |
| 19-D326 | 33 |
| 19-D327 | 33 |
| 19-D330 | 27 |
| 19-D334 | 33 |
| 19-D340LG | 27 |
| 19-D3400R | 27 |

| ITEM NUMBER | PAGE NUMBER |
|--------------------------------|-------------|
| 19-D350 | 38 |
| 19-D355 | 33 |
| 19-D360 | 33 |
| 19-D470 | 30 |
| 19-D475 | 30 |
| 19-D526B | 27 |
| 19-D534B | 27 |
| 19-D650 | 41 |
| 19-D655 | 41 |
| 20-21DACP18-ET | 133 |
| 20-D18 | 139 |
| 20-DA18 | 139 |
| 20-DA18CL | 139 |
| 20-DA18S | 139 |
| 20-DA4210 | 139 |
| 20-DAPB22TOV | 139 |
| 20-SD18 | 139 |
| 20-TG18 | 139 |
| 20-TG18S | 139 |
| 22-600 | 49 |
| 22-600BK | 49 |
| 22-601 | 49 |
| 22-615 | 49 |
| 22-650 | 49 |
| 22-720 | 49 |
| 22-730 | 51 |
| 22-750 | 49 |
| 22-751 | 49 |
| 22-760 | 49 |
| 22-760BB | 49 |
| 22-760BG | 49 |
| 22-760G | 49 |
| 22-760GRN | 49 |
| 22-760NP | 49 |
| 22-7600R | 49 |
| 22-770 | 49 |
| 22-900 | 49 |
| 23-44182 | 144 |
| 25-612 | 144 |
| 25-618 | 144 |
| 25-621 | 144 |
| 25-7612BB | 144 |
| 25-7612BG | 144 |
| 25-7612GRN | 144 |

| ITEM NUMBER | PAGE NUMBER |
|---------------------------|-------------|
| 25-7612NP | 144 |
| 30-6775B | 144 |
| 30-6775W | 144 |
| 30-6795B | 144 |
| 30-6795W | 144 |
| 31-48182 | 144 |
| 31-C-18 | 140 |
| 31-CDS18 | 140 |
| 31-CS18 | 140 |
| 33-115 | 64 |
| 33-125 | 64 |
| 33-325 | 64 |
| 33-425LY | 64 |
| 33-4250R | 64 |
| 33-825 | 64 |
| 33-B115 | 64 |
| 33-B125 | 64 |
| 33-G115 | 64 |
| 33-G125 | 64 |
| 33-GT125 | 64 |
| 34-1743 | 44 |
| 34-225 | 62 |
| 34-244 | 59 |
| 34-245 | 59 |
| 34-274 | 59 |
| 34-275 | 59 |
| 34-300 | 62 |
| 34-400 | 62 |
| 34-500 | 62 |
| 34-600 | 65 |
| 34-6743 | 44 |
| 34-800 | 60 |
| 34-8014 | 57 |
| 34-824 | 60 |
| 34-8264 | 60 |
| 34-844 | 58 |
| 34-8443 | 44 |
| 34-845 | 58 |
| 34-8453 | 44 |
| 34-846 | 58 |
| 34-874 | 57 |
| 34-8743 | 44 |
| 34-8743FY | 44 |
| 34-8745 | 58 |

INDEX

BRINGING THE BEST OF THE WORLD TO YOU®

| ITEM NUMBER | PAGE NUMBER |
|-------------------------------|-------------|
| 34-874FY | 57 |
| 34-875 | 57 |
| 34-8753 | 44 |
| 34-876 | 57 |
| 34-900 | 60 |
| 34-9025 | 60 |
| 34-C229 | 62 |
| 34-C232 | 62 |
| 34-C234 | 62 |
| 35-C103 | 68 |
| 35-C104 | 68 |
| 35-C110 | 68 |
| 35-C115 | 68 |
| 35-C119 | 68 |
| 35-C2110 | 68 |
| 35-C2113 | 68 |
| 35-C410 | 68 |
| 35-C500 | 68 |
| 35-C510 | 68 |
| 35-CB110 | 68 |
| 35-CB604 | 68 |
| 35-G410 | 68 |
| 35-G510 | 68 |
| 36-110BB | 67 |
| 36-110PC-BK | 67 |
| 36-110PC-BL | 67 |
| 36-110PD | 67 |
| 36-110PDD | 67 |
| 36-110PDD-WT | 67 |
| 36-110VV | 67 |
| 36-112PDD | 67 |
| 36-C330PD | 67 |
| 36-C330PDD | 67 |
| 37-C110B | 67 |
| 37-C110BB | 67 |
| 37-C110PC-BK | 67 |
| 37-C110PC-BL | 67 |
| 37-C110PD | 67 |
| 37-C110PDD | 67 |
| 37-C110PDD-BL | 67 |
| 37-C110PDD-WT | 67 |
| 37-C112PDD | 67 |
| 37-C119PD | 67 |
| 37-C119PDD | 67 |

| ITEM NUMBER | PAGE NUMBER |
|-------------------------------|-------------|
| 37-C2110PC-BL | 67 |
| 37-C2110PC-RT | 67 |
| 37-C2110PD | 67 |
| 37-C2110PDD | 67 |
| 37-C2110PD-WT | 67 |
| 37-C500BB-BL | 67 |
| 37-C500PDD | 67 |
| 37-C512PDD-BL | 67 |
| 38-1410 | 62 |
| 38-1460 | 62 |
| 38-620 | 62 |
| 38-625 | 62 |
| 38-630 | 62 |
| 38-635 | 62 |
| 38-720 | 126 |
| 38-720 | 67 |
| 38-N2110PC | 67 |
| 39-1310 | 63 |
| 39-3013 | 67 |
| 39-C120 | 63 |
| 39-C121 | 63 |
| 39-C122 | 63 |
| 39-C1300 | 63 |
| 39-C1305 | 63 |
| 39-C1375 | 63, 117 |
| 39-C1500 | 63 |
| 39-C1600 | 63 |
| 40-130 | 105 |
| 40-230 | 105 |
| 40-630 | 105 |
| 40-6410 | 105 |
| 40-6411 | 105 |
| 40-6415 | 105 |
| 40-6416 | 105 |
| 40-730 | 105 |
| 40-732 | 105 |
| 40-736 | 105 |
| 40-750 | 105 |
| 40-C125 | 105 |
| 40-C2130 | 105 |
| 40-C2210 | 105 |
| 41-001 | 121 |
| 41-001NB | 121 |
| 41-001W | 121 |

| ITEM NUMBER | PAGE NUMBER |
|--------------------------|-------------|
| 41-002 | 121 |
| 41-005 | 121 |
| 41-010 | 121 |
| 41-011 | 121 |
| 41-013 | 121 |
| 41-070 | 121 |
| 41-075 | 121 |
| 41-130 | 121 |
| 41-1400 | 119 |
| 41-1405 | 119 |
| 41-1415 | 62, 120 |
| 41-1420 | 120 |
| 41-1425 | 63, 120 |
| 41-1430 | 119 |
| 41-1475 | 119 |
| 42-215 | 125 |
| 42-329 | 125 |
| 42-811 | 125 |
| 42-853 | 125 |
| 42-857 | 125 |
| 42-C700 | 125 |
| 42-C713 | 125 |
| 42-C750 | 125 |
| 42-C753 | 125 |
| 42-C920 | 125 |
| 43-500 | 126 |
| 43-502 | 126 |
| 43-552 | 126 |
| 43-802 | 126 |
| 43-850 | 126 |
| 43-851 | 126 |
| 43-858 | 126 |
| 43-859 | 126 |
| 44-1745 | 36 |
| 44-3445 | 36 |
| 44-3455 | 36 |
| 44-3745 | 36 |
| 44-3755 | 36 |
| 44-6745 | 36 |
| 47-L161B | 85 |
| 47-L161N | 85 |
| 47-L170Y | 85 |
| 47-L171B | 85 |
| 47-L171N | 85 |

| ITEM NUMBER | PAGE NUMBER |
|---------------------------|-------------|
| 47-L210T | 85 |
| 47-L442 | 85 |
| 48-L140Y | 85 |
| 48-L160Y | 85 |
| 48-L162Y | 85 |
| 48-L185B | 85 |
| 48-L185P | 85 |
| 48-L185T | 85 |
| 48-L185Y | 85 |
| 48-L187Y | 85 |
| 48-L2125Y | 85 |
| 48-L212Y | 85 |
| 48-L300K | 85 |
| 48-L302T | 85 |
| 50-N092B | 86 |
| 50-N110G | 86 |
| 50-N115G | 86 |
| 50-N140B | 86 |
| 50-N140G | 86 |
| 50-N150G | 86 |
| 50-N160B | 86 |
| 50-N160G | 86 |
| 50-N2250G | 86 |
| 50-N2272G | 86 |
| 50-NKHT1 | 86 |
| 52-3665 | 87 |
| 52-3670 | 87 |
| 52-3671 | 87 |
| 52-3672 | 87 |
| 55-1600 | 63 |
| 55-1635 | 85 |
| 55-3243 | 69 |
| 55-3253 | 69 |
| 55-3271 | 69 |
| 55-3273 | 69 |
| 55-3274 | 69 |
| 55-AG315 | 63 |
| 55-AG316 | 63 |
| 55-AG317 | 63 |
| 56-3143 | 71 |
| 56-3145 | 71 |
| 56-3147 | 71 |
| 56-3151 | 71 |
| 56-3152 | 71 |

| ITEM NUMBER | PAGE NUMBER |
|---------------------------|-------------|
| 56-3153 | 71 |
| 56-3154 | 71 |
| 56-3170 | 71 |
| 56-3171 | 71 |
| 56-3175 | 71 |
| 56-3176 | 71 |
| 56-3180 | 71 |
| 56-3185 | 71 |
| 56-3186 | 71 |
| 56-3195 | 71 |
| 56-424 | 61 |
| 56-425 | 61 |
| 56-426 | 61 |
| 56-451 | 61 |
| 56-530 | 61 |
| 56-630 | 89 |
| 56-633 | 89 |
| 56-635 | 89 |
| 56-AG566 | 93 |
| 56-AG567 | 93 |
| 56-AG585 | 93 |
| 56-AG586 | 93 |
| 56-AG588 | 93 |
| 57-8615 | 93 |
| 57-8630 | 93 |
| 57-8630R | 93 |
| 57-8640R | 93 |
| 57-8643R | 93 |
| 57-8645 | 93 |
| 57-8645R | 93 |
| 57-8653R | 93 |
| 57-8675 | 93 |
| 58-7303 | 92, 121 |
| 58-7304 | 92, 121 |
| 58-7305 | 92, 121 |
| 58-7313 | 92, 121 |
| 58-7315 | 92, 121 |
| 58-8015 | 91 |
| 58-8015DD | 91 |
| 58-8015R | 91 |
| 58-8020 | 91 |
| 58-8020DD | 91 |
| 58-8020R | 91 |
| 58-8025DD | 91 |

| ITEM NUMBER | PAGE NUMBER |
|---------------------------|-------------|
| 58-8030 | 91 |
| 58-8030DD | 91 |
| 58-8030R | 91 |
| 58-8030Y | 91 |
| 58-8035DD | 91 |
| 58-8040 | 91 |
| 58-8040DD | 91 |
| 58-8040R | 91 |
| 58-8040Y | 91 |
| 58-8060 | 91 |
| 58-8115DD | 91 |
| 58-8120DD | 91 |
| 58-8130DD | 91 |
| 58-8140DD | 91 |
| 58-8215DD | 91 |
| 58-8230DD | 91 |
| 58-8240DD | 91 |
| 58-8362 | 91 |
| 58-8364 | 91 |
| 58-8414R | 91 |
| 58-8431R | 91 |
| 58-8650 | 92, 121 |
| 58-8651 | 92, 121 |
| 58-8655 | 92 |
| 58-8656 | 92 |
| 58-8657 | 92 |
| 58-8658DL | 92 |
| 58-8658K | 91 |
| 59-2115 | 72 |
| 59-2515 | 72 |
| 60-3105 | 72 |
| 60-3106 | 72 |
| 60-3107 | 72 |
| 60-3140 | 72 |
| 61-249L | 72 |
| 61-249M | 72 |
| 62-310 | 98 |
| 62-321PF | 98 |
| 62-322 | 98 |
| 62-322PF | 98 |
| 62-323 | 98 |
| 62-323PF | 98 |
| 62-327 | 99 |
| 62-327PF | 99 |

| ITEM NUMBER | PAGE NUMBER |
|----------------------------|-------------|
| 62-350 | 98 |
| 63-230PF | 96 |
| 63-3314PF | 96 |
| 63-331PF | 96 |
| 63-332 | 96 |
| 63-332PF | 96 |
| 63-336 | 96 |
| 63-336PF | 96 |
| 63-338 | 96 |
| 63-338PF | 96 |
| 63-510PF | 96 |
| 63-532 | 96 |
| 63-532PF | 96 |
| 63-550PF | 96 |
| 63-632PF | 96 |
| 63-732PF | 96 |
| 64-346 | 100 |
| 64-346PF | 100 |
| 64-433 | 100 |
| 64-436 | 100 |
| 64-V2000 | 100 |
| 64-V2000PF | 100 |
| 64-V3000 | 100 |
| 64-V3000PF | 100 |
| 64-V77B | 100 |
| 64-V77BPF | 100 |
| 65-543 | 100 |
| 65-544 | 100 |
| 65-545 | 100 |
| 65-553 | 100 |
| 67-246 | 97 |
| 67-306 | 97 |
| 67-308 | 97 |
| 68-101 | 77 |
| 68-101G | 77 |
| 68-103 | 77 |
| 68-105 | 77 |
| 68-106 | 77 |
| 68-116 | 77 |
| 68-118 | 77 |
| 68-153 | 77 |
| 68-158 | 77 |
| 68-161SB | 77 |
| 68-162 | 77 |

| ITEM NUMBER | PAGE NUMBER |
|----------------------------|-------------|
| 68-162SB | 77 |
| 68-163 | 77 |
| 68-163HV | 77 |
| 68-163SB | 77 |
| 68-165 | 77 |
| 68-165HV | 77 |
| 68-168 | 77 |
| 69-134 | 78 |
| 69-138 | 78 |
| 69-148 | 78 |
| 69-189 | 78 |
| 70-300 | 77 |
| 70-301 | 77 |
| 70-318 | 77 |
| 70-360 | 77 |
| 70-360SB | 77 |
| 70-361 | 77 |
| 70-368 | 77 |
| 71-3600 | 77 |
| 71-3601 | 77 |
| 71-3618 | 77 |
| 73-1700 | 118 |
| 73-1703 | 117 |
| 73-2000 | 117 |
| 73-7007 | 123 |
| 73-7007LHO | 123 |
| 73-7007RHO | 123 |
| 73-7015 | 123 |
| 73-7015A | 123 |
| 73-7018 | 123 |
| 73-7080 | 123 |
| 73-7085 | 123 |
| 73-7088 | 123 |
| 73-7150 | 123 |
| 73-7250 | 123 |
| 73-888 | 123 |
| 73-888A | 123 |
| 73-888LHO | 123 |
| 73-888RHO | 123 |
| 73-K1800 | 29, 118 |
| 74-SC7104 | 124 |
| 75-2022 | 124 |
| 75-2026 | 124 |
| 75-320 | 124 |

| ITEM NUMBER | PAGE NUMBER |
|-----------------------------|-------------|
| 75-320/LHO | 124 |
| 75-320/RHO | 124 |
| 75-4854 | 124 |
| 75-4904 | 124 |
| 77-208 | 122 |
| 77-218 | 122 |
| 77-238 | 122 |
| 77-265 | 122 |
| 77-268 | 122 |
| 77-269 | 122 |
| 77-289 | 122 |
| 77-289TL | 122 |
| 77-298 | 122 |
| 77-418 | 122 |
| 77-468 | 122 |
| 77-469 | 122 |
| 78-3927 | 122 |
| 78-3927KW | 122 |
| 78-7825 | 122 |
| 78-7863B | 122 |
| 80-8800 | 81 |
| 80-8844 | 81 |
| 80-8846 | 81 |
| 80-8855 | 82 |
| 80-8866 | 82 |
| 80-8889 | 81 |
| 81-7563YB | 81 |
| 82-5044 | 81 |
| 82-5066 | 81 |
| 82-7563 | 81 |
| 82-7563ID | 82 |
| 82-7583 | 81 |
| 82-7663 | 81 |
| 82-7683D | 81 |
| 82-7763 | 82 |
| 83-6033 | 81 |
| 83-6563 | 81 |
| 83-6563/LHO | 81 |
| 83-6563/RHO | 81 |
| 83-6663 | 81 |
| 83-6733 | 82 |
| 83-6763 | 82 |
| 84-6532 | 82 |
| 84-7532 | 82 |

| ITEM NUMBER | PAGE NUMBER |
|----------------------------|-------------|
| 84-7532A | 82 |
| 84-7533 | 82 |
| 84-7533J | 82 |
| 84-7632 | 82 |
| 84-7633 | 82 |
| 85-7500 | 82 |
| 85-7500P | 82 |
| 85-7500S | 82 |
| 85-7512 | 82 |
| 85-7512C | 82 |
| 85-7512CS | 82 |
| 85-7512J | 82 |
| 85-7513P | 82 |
| 85-7612S | 82 |
| 85-DB7563 | 82 |
| 85-DB7563P | 82 |
| 86-4104 | 82 |
| 86-4104C | 82 |
| 86-4104P | 82 |
| 86-4144 | 82 |
| 86-4244 | 81 |
| 86-6044 | 81 |
| 87-1563 | 79 |
| 87-1563P | 79 |
| 87-1663 | 79 |
| 87-1944 | 79 |
| 87-2066 | 79 |
| 87-3501 | 79 |
| 87-3563 | 79 |
| 90-908 | 74 |
| 90-908/5KW | 74 |
| 90-908BT | 74 |
| 90-908BW | 74 |
| 90-908C | 74 |
| 90-908CI | 74 |
| 90-908I | 74 |
| 90-909I | 74 |
| 90-910 | 74 |
| 90-910C | 74 |
| 90-910G | 74 |
| 90-910GA | 74 |
| 90-910I | 74 |
| 90-912 | 74 |
| 90-912I | 74 |

| ITEM NUMBER | PAGE NUMBER |
|-----------------------------|-------------|
| 91-908PD | 73 |
| 91-908PDC | 73 |
| 91-908PDI | 73 |
| 91-910PD | 73 |
| 91-910PDI | 73 |
| 91-910PDL | 73 |
| 91-910PDL-R | 73 |
| 91-910PDO | 73 |
| 92-918 | 74 |
| 92-918BT | 74 |
| 92-918BTO | 74 |
| 92-918G | 74 |
| 92-918GO | 74 |
| 92-918O | 74 |
| 92-918PC | 74 |
| 92-918PCG | 74 |
| 92-918PCGB | 74 |
| 92-918PCO | 74 |
| 92-918PCY | 74 |
| 93-548 | 75 |
| 93-568 | 75 |
| 93-578G | 75 |
| 93-588 | 75 |
| 93-589 | 75 |
| 93-598 | 75 |
| 94-924 | 125 |
| 94-924G | 125 |
| 94-924I | 125 |
| 94-924R | 125 |
| 94-928 | 125 |
| 94-928G | 125 |
| 94-928I | 125 |
| 94-930 | 125 |
| 94-932 | 125 |
| 94-932G | 125 |
| 94-934 | 125 |
| 95-606 | 75 |
| 95-606B | 75 |
| 95-606C | 75 |
| 95-806 | 75 |
| 95-806C | 75 |
| 95-808 | 75 |
| 95-809 | 75 |
| 95-809C | 75 |

| ITEM NUMBER | PAGE NUMBER |
|-----------------------------|-------------|
| 95-809PD | 75 |
| 95-809PDC | 75 |
| 95-864 | 75 |
| 95-890 | 75 |
| 97-500 | 106 |
| 97-500/10 | 106 |
| 97-500/12 | 106 |
| 97-500/14 | 106 |
| 97-500/14I | 106 |
| 97-500/14NI | 106 |
| 97-500H | 106 |
| 97-500I | 106 |
| 97-500J | 106 |
| 97-501 | 106 |
| 97-501/10 | 106 |
| 97-501/12 | 106 |
| 97-501H | 106 |
| 97-501I | 106 |
| 97-511 | 106 |
| 97-520 | 106, 130 |
| 97-520/10 | 106 |
| 97-520/12 | 106 |
| 97-520/12R | 106 |
| 97-520/14 | 106 |
| 97-520H | 106, 130 |
| 97-520J | 106 |
| 97-520R | 106, 130 |
| 97-521 | 106, 130 |
| 97-521/10 | 106 |
| 97-521H | 106 |
| 97-540 | 107 |
| 97-540/12 | 107 |
| 97-540H | 107 |
| 97-540R | 107 |
| 97-541 | 107 |
| 97-541/12 | 107 |
| 97-541H | 107 |
| 98-700 | 107 |
| 98-701 | 107 |
| 98-702 | 107 |
| 98-702/12 | 107 |
| 98-702I | 107 |
| 98-703 | 107 |

INDEX

BRINGING THE BEST OF THE WORLD TO YOU®

| ITEM NUMBER | PAGE NUMBER |
|-------------------------------|-------------|
| 98-703/12 | 107 |
| 98-703I | 107 |
| 98-712 | 107 |
| 98-713 | 107 |
| 98-740 | 107 |
| 98-741 | 107 |
| 99-126 | 105 |
| 100-2824 | 103 |
| 100-2830 | 103 |
| 100-3201PF | 102 |
| 100-322400 | 103 |
| 100-323000 | 103 |
| 100-323010 | 103 |
| 100-332400 | 103 |
| 100-333000 | 103 |
| 100-333010 | 103 |
| 100-93-183638 | 108 |
| 100-93-184538 | 108 |
| 100-93-243638 | 108 |
| 100-93-264538 | 108 |
| 100-93-264564 | 108 |
| 100-93-363638 | 108 |
| 100-93-363664 | 108 |
| 100-93-364538 | 108 |
| 100-93-364564 | 108 |
| 100-93-366064 | 108 |
| 100-95-501 | 108 |
| 120-4000 | 110 |
| 120-4050 | 110 |
| 120-4070 | 110 |
| 120-4100 | 113 |
| 120-4150 | 113 |
| 120-4200 | 113 |
| 120-4300 | 114 |
| 120-4400 | 114 |
| 120-4500 | 114 |
| 120-4600 | 114 |
| 120-4700 | 112 |
| 120-4720 | 112 |
| 120-4800 | 117 |
| 120-4900 | 114 |
| 120-5130 | 46, 110 |
| 120-5150 | 46, 110 |
| 120-5200 | 111 |

| ITEM NUMBER | PAGE NUMBER |
|-----------------------------|-------------|
| 120-5250 | 111 |
| 120-5275 | 111 |
| 120-5300 | 111 |
| 120-5900 | 112 |
| 120-MX2805 | 115 |
| 120-MX2820 | 115 |
| 120-MX2830 | 115 |
| 120-MX2840 | 115 |
| 122-169 | 116 |
| 122-AV14 | 116 |
| 122-AV20 | 116 |
| 122-AV40 | 116 |
| 122-AV70 | 116 |
| 122-AV71 | 116 |
| 125-348 | 77 |
| 125-368 | 77 |
| 125-7563 | 81 |
| 130-100GM | 130 |
| 130-100WM | 130 |
| 130-100WMNZ | 107, 130 |
| 130-100WMPD | 130 |
| 130-150WM | 130 |
| 130-600WL | 129 |
| 130-600WM | 129 |
| 130-650BM | 129 |
| 130-650WL | 129 |
| 130-650WM | 129 |
| 147-00-11 | 259 |
| 147-0-11 | 259 |
| 147-1-14 | 259 |
| 147-2-14 | 259 |
| 147-SK-0 | 260 |
| 147-SK-00 | 260 |
| 147-SK-1 | 260 |
| 147-SK-2 | 260 |
| 148-1000 | 260 |
| 148-2000 | 260 |
| 148-2136 | 260 |
| 148-2142 | 260 |
| 148-4000 | 260 |
| 148-5000 | 260 |
| 148-6000 | 260 |
| 148-6011 | 260 |
| 148-6014 | 260 |

| ITEM NUMBER | PAGE NUMBER |
|---------------------------|-------------|
| 148-6016 | 260 |
| 148-6018 | 260 |
| 148-7000 | 260 |
| 150-00-11 | 259 |
| 150-00-14 | 259 |
| 150-0-11 | 259 |
| 150-0-14 | 259 |
| 150-1-14 | 259 |
| 150-2-14 | 259 |
| 150-3-16 | 259 |
| 150-3-18 | 259 |
| 150-SK-0 | 260 |
| 150-SK-00 | 260 |
| 150-SK-1 | 260 |
| 150-SK-2 | 260 |
| 151-2-18 | 259 |
| 151-3-18 | 259 |
| 152-2-16 | 259 |
| 152-2-18 | 259 |
| 153-00-11 | 259 |
| 153-0-11 | 259 |
| 153-1-14 | 259 |
| 154-2-16 | 259 |
| 154-2-18 | 259 |
| 155-0-11 | 259 |
| 155-1-14 | 259 |
| 155-1-16 | 259 |
| 155-2-14 | 259 |
| 155-2-16 | 259 |
| 155-2-18 | 259 |
| 155-3-16 | 259 |
| 155-3-18 | 259 |
| 155-4-16 | 259 |
| 155-4-18 | 259 |
| 155-SK-2 | 260 |
| 156-2-14 | 259 |
| 158-1-18 | 259 |
| 158-2-18 | 259 |
| 158-3-18 | 259 |
| 158-4-18 | 259 |
| 159-2-16 | 259 |
| 159-2-18 | 259 |
| 159-3-16 | 259 |
| 159-3-18 | 259 |

| ITEM NUMBER | PAGE NUMBER |
|-------------------------------|-------------|
| 159-4-16 | 259 |
| 159-4-18 | 259 |
| 161-2-16 | 259 |
| 161-2-18 | 259 |
| 162-2-18 | 259 |
| 170-00-11 | 259 |
| 170-00-14 | 259 |
| 170-0-11 | 259 |
| 170-0-14 | 259 |
| 170-2-14 | 259 |
| 190-2-LARGE | 259 |
| 190-2-REGULAR | 259 |
| 190-2-XLARGE | 259 |
| 195-2-LARGE | 259 |
| 195-2-REGULAR | 259 |
| 195-2-XLARGE | 259 |
| 197-2-LARGE | 259 |
| 197-2-REGULAR | 259 |
| 197-2-XLARGE | 259 |
| 200-010 | 242 |
| 200-01001 | 242 |
| 200-01002 | 242 |
| 200-011 | 242 |
| 200-012 | 242 |
| 200-06001 | 242 |
| 200-06002 | 242 |
| 200-07501 | 242 |
| 200-08001 | 242 |
| 200-12501 | 242 |
| 200-20001 | 242 |
| 200-91018 | 242 |
| 200-BC18 | 242 |
| 200-BC21 | 242 |
| 200-BC24 | 242 |
| 200-BG01 | 242 |
| 201-100 | 240 |
| 201-250 | 240 |
| 201-300 | 240 |
| 201-320 | 240 |
| 201-322 | 240 |
| 201-340 | 240 |
| 201-350 | 240 |
| 201-350B | 240 |
| 201-350J | 240 |

| ITEM NUMBER | PAGE NUMBER |
|-------------------------------|-------------|
| 201-350P | 240 |
| 201-355 | 240 |
| 201-360 | 240 |
| 201-370 | 240 |
| 201-650B | 237 |
| 201-650C | 237 |
| 201-650J | 237 |
| 202-100 | 166 |
| 202-101 | 166 |
| 202-1012 | 108 |
| 202-1015 | 108 |
| 202-1019 | 108 |
| 202-102 | 166 |
| 202-1027 | 108 |
| 202-110 | 166 |
| 202-112 | 166 |
| 202-130 | 166 |
| 202-132 | 166 |
| 202-2036 | 108 |
| 202-2042 | 108 |
| 202-2048 | 108 |
| 202-2054 | 108 |
| 205-300FR | 240 |
| 205-320FR | 240 |
| 205-322FR | 240 |
| 205-370FR | 240 |
| 205-375FR | 238 |
| 205-420B | 236 |
| 205-420CV | 236 |
| 205-420JH | 236 |
| 248-4400-300 | 211 |
| 248-4400-400 | 211 |
| 248-4401-300 | 211 |
| 248-4401-400 | 211 |
| 248-5090-300B | 211 |
| 248-5090-400B | 211 |
| 248-5190-300B | 211 |
| 248-5190-400B | 211 |
| 248-5290-300B | 211 |
| 248-5290-400B | 211 |
| 249-5907-207 | 200 |
| 249-5907-400 | 200 |
| 249-5907-401 | 200 |
| 250-00-0000 | 191 |

| ITEM NUMBER | PAGE NUMBER |
|-----------------------------|-------------|
| 250-00-0001 | 191 |
| 250-00-0002 | 191 |
| 250-00-0020 | 191 |
| 250-00-0900 | 191 |
| 250-00-0920 | 191 |
| 250-01-0000 | 190 |
| 250-01-0001 | 190 |
| 250-01-0002 | 190 |
| 250-01-0004 | 190 |
| 250-01-0005 | 190 |
| 250-01-0020 | 190 |
| 250-01-0021 | 190 |
| 250-01-0080 | 190 |
| 250-01-0900 | 190 |
| 250-01-0902 | 190 |
| 250-01-0920 | 190 |
| 250-01-0980 | 190 |
| 250-01-5503 | 190 |
| 250-01-5504 | 190 |
| 250-01-5509 | 190 |
| 250-01-F020 | 205 |
| 250-01-F021 | 205 |
| 250-01-F022 | 205 |
| 250-03-0000 | 203 |
| 250-03-0001 | 203 |
| 250-03-0080 | 203 |
| 250-06-0000 | 191 |
| 250-06-0002 | 191 |
| 250-06-0005 | 191 |
| 250-06-0006 | 191 |
| 250-06-0020 | 191 |
| 250-06-0080 | 191 |
| 250-06-5501 | 191 |
| 250-06-5503 | 191 |
| 250-06-5504 | 191 |
| 250-06-5509 | 191 |
| 250-06-5521 | 191 |
| 250-08-0000 | 191 |
| 250-08-0001 | 191 |
| 250-08-0002 | 191 |
| 250-08-0005 | 191 |
| 250-08-0020 | 191 |
| 250-08-0021 | 191 |
| 250-08-5503 | 191 |

| ITEM NUMBER | PAGE NUMBER |
|-----------------------------|-------------|
| 250-08-5509 | 191 |
| 250-09-0000 | 189 |
| 250-09-0001 | 189 |
| 250-09-0002 | 189 |
| 250-09-0020 | 189 |
| 250-09-0021 | 189 |
| 250-10-0900 | 192 |
| 250-10-0904 | 192 |
| 250-10-0920 | 192 |
| 250-10-5501 | 192 |
| 250-11-0900 | 192 |
| 250-11-0904 | 192 |
| 250-11-0920 | 192 |
| 250-11-5501 | 192 |
| 250-12-0100 | 192, 207 |
| 250-12-0125 | 192, 207 |
| 250-12-0150 | 192, 207 |
| 250-12-0175 | 192, 207 |
| 250-12-0200 | 192, 207 |
| 250-12-0225 | 192, 207 |
| 250-12-0250 | 192, 207 |
| 250-12-0275 | 192, 207 |
| 250-12-0300 | 192, 207 |
| 250-21-0100 | 198 |
| 250-21-0101 | 198 |
| 250-21-0102 | 198 |
| 250-21-0120 | 198 |
| 250-21-0400 | 198 |
| 250-21-0401 | 198 |
| 250-21-0402 | 198 |
| 250-21-0403 | 198 |
| 250-21-0409 | 198 |
| 250-21-0420 | 198 |
| 250-21-0421 | 198 |
| 250-24-0000 | 198 |
| 250-24-0001 | 198 |
| 250-24-0080 | 198 |
| 250-24-0300 | 198 |
| 250-24-0301 | 198 |
| 250-25-0010 | 207 |
| 250-25-0015 | 207 |
| 250-25-0020 | 207 |
| 250-25-0025 | 207 |
| 250-25-0030 | 207 |

| ITEM NUMBER | PAGE NUMBER |
|-----------------------------|-------------|
| 250-25-0115 | 207 |
| 250-25-0120 | 207 |
| 250-25-0125 | 207 |
| 250-25-0130 | 207 |
| 250-25-1515 | 207 |
| 250-25-2020 | 207 |
| 250-25-2525 | 207 |
| 250-26-0010 | 206 |
| 250-26-0012 | 206 |
| 250-26-0015 | 206 |
| 250-26-0017 | 206 |
| 250-26-0020 | 206 |
| 250-26-0022 | 206 |
| 250-26-0025 | 206 |
| 250-26-0030 | 206 |
| 250-27-0010 | 206 |
| 250-27-0012 | 206 |
| 250-27-0015 | 206 |
| 250-27-0017 | 206 |
| 250-27-0020 | 206 |
| 250-27-0022 | 206 |
| 250-27-0025 | 206 |
| 250-27-0027 | 206 |
| 250-27-0030 | 206 |
| 250-27-0115 | 206 |
| 250-27-0120 | 206 |
| 250-27-0125 | 206 |
| 250-27-0130 | 206 |
| 250-28-0000 | 199 |
| 250-28-0001 | 199 |
| 250-28-0002 | 199 |
| 250-28-0003 | 199 |
| 250-28-0006 | 199 |
| 250-28-0009 | 199 |
| 250-28-0020 | 199 |
| 250-28-0021 | 199 |
| 250-31-0010 | 196 |
| 250-31-0020 | 196 |
| 250-31-0021 | 196 |
| 250-31-0023 | 196 |
| 250-31-0026 | 196 |
| 250-31-0029 | 196 |
| 250-31-0031 | 196 |
| 250-31-0226 | 196 |

| ITEM NUMBER | PAGE NUMBER |
|-----------------------------|-------------|
| 250-32-0010 | 186 |
| 250-32-0020 | 186 |
| 250-32-0021 | 186 |
| 250-32-0031 | 186 |
| 250-32-0226 | 186 |
| 250-32-0520 | 186 |
| 250-32-0521 | 186 |
| 250-33-0010 | 181 |
| 250-33-0020 | 181 |
| 250-33-0021 | 181 |
| 250-33-0041 | 181 |
| 250-33-0226 | 181 |
| 250-33-1010 | 181 |
| 250-33-1020 | 181 |
| 250-33-1024 | 181 |
| 250-33-1042 | 181 |
| 250-33-1226 | 181 |
| 250-34-0010 | 197, 205 |
| 250-34-0020 | 197, 205 |
| 250-34-0021 | 197, 205 |
| 250-34-0031 | 197, 205 |
| 250-34-0226 | 197, 205 |
| 250-34-FOAM | 197, 205 |
| 250-36-0010 | 184 |
| 250-36-0020 | 184 |
| 250-36-0021 | 184 |
| 250-36-0025 | 184 |
| 250-36-0226 | 184 |
| 250-36-1010 | 184 |
| 250-36-1020 | 184 |
| 250-36-1021 | 184 |
| 250-36-1226 | 184 |
| 250-37-0900 | 203 |
| 250-37-0980 | 203 |
| 250-45-0010 | 185 |
| 250-45-0020 | 185 |
| 250-45-0021 | 185 |
| 250-45-0226 | 185 |
| 250-45-1010 | 185 |
| 250-45-1020 | 185 |
| 250-45-1021 | 185 |
| 250-45-1226 | 185 |
| 250-46-0010 | 187 |
| 250-46-0020 | 187 |

| ITEM NUMBER | PAGE NUMBER |
|-----------------------------|-------------|
| 250-46-0021 | 187 |
| 250-46-0226 | 187 |
| 250-46-0520 | 187 |
| 250-46-0521 | 187 |
| 250-47-0004 | 178 |
| 250-47-0005 | 178 |
| 250-47-0006 | 178 |
| 250-47-0007 | 178 |
| 250-47-0020 | 178 |
| 250-47-0021 | 178 |
| 250-47-0041 | 178 |
| 250-47-1008 | 178 |
| 250-47-1042 | 178 |
| 250-48-0006 | 198 |
| 250-48-0021 | 198 |
| 250-48-0226 | 198 |
| 250-49-0000 | 195 |
| 250-49-0020 | 195 |
| 250-49-0021 | 195 |
| 250-49-0022 | 195 |
| 250-50-0420 | 204 |
| 250-50-0421 | 204 |
| 250-50-0422 | 204 |
| 250-50-0425 | 204 |
| 250-50-0426 | 204 |
| 250-50-0429 | 204 |
| 250-50-0520 | 204 |
| 250-50-0521 | 204 |
| 250-51-0015 | 204, 207 |
| 250-51-0020 | 204, 207 |
| 250-51-0025 | 204, 207 |
| 250-51-0030 | 204, 207 |
| 250-53-0006 | 179 |
| 250-53-0020 | 179 |
| 250-53-0021 | 179 |
| 250-53-0022 | 179 |
| 250-53-1024 | 179 |
| 250-57-0004 | 180 |
| 250-57-0008 | 180 |
| 250-57-0020 | 180 |
| 250-57-0021 | 180 |
| 250-57-0226 | 180 |
| 250-60-0020 | 201 |
| 250-60-0620 | 201 |

| ITEM NUMBER | PAGE NUMBER |
|------------------------------|-------------|
| 250-60-0625 | 201 |
| 250-60-0626 | 201 |
| 250-60-0628 | 201 |
| 250-60-0630 | 201 |
| 250-71-0000 | 195 |
| 250-71-0001 | 195 |
| 250-71-0002 | 195 |
| 250-71-0005 | 195 |
| 250-71-0020 | 195 |
| 250-71-0021 | 195 |
| 250-92-0000 | 194 |
| 250-92-0001 | 194 |
| 250-92-0002 | 194 |
| 250-92-0005 | 194 |
| 250-92-0009 | 194 |
| 250-92-0020 | 194 |
| 250-92-0021 | 194 |
| 250-98-0000 | 203 |
| 250-98-0013 | 203 |
| 250-98-0020 | 203 |
| 250-98-0080 | 203 |
| 250-99-0900 | 202 |
| 250-99-0901 | 202 |
| 250-99-0980 | 202 |
| 250-AN-10110 | 183 |
| 250-AN-10111 | 183 |
| 250-AN-10112 | 183 |
| 250-AN-10113 | 183 |
| 250-AN-10114 | 183 |
| 250-AN-10115 | 183 |
| 250-AN-10116 | 183 |
| 250-AN-10117 | 183 |
| 250-AN-10118 | 183 |
| 250-AN-10119 | 183 |
| 250-AN-10120 | 183 |
| 250-AN-10121 | 183 |
| 250-AN-10122 | 183 |
| 250-AN-10123 | 183 |
| 250-AN-10124 | 183 |
| 250-AN-10125 | 183 |
| 250-AN-10126 | 183 |
| 250-AN-10127 | 183 |
| 250-AN-10128 | 183 |
| 250-AN-10130 | 183 |

| ITEM NUMBER | PAGE NUMBER |
|----------------------------------|-------------|
| 250-AN-10131 | 183 |
| 250-CE-10090 | 205 |
| 250-CE-10091 | 205 |
| 250-CE-10092 | 205 |
| 250-CE-10093 | 205 |
| 250-CE-10095 | 205 |
| 250-EVS-0000 | 158 |
| 250-EVS-0001 | 158 |
| 250-EVS-0002 | 158 |
| 250-MT-10070 | 195 |
| 250-MT-10071 | 195 |
| 250-MT-10072 | 195 |
| 250-MT-10074 | 195 |
| 250-MT-10075 | 195 |
| 251-01-5200 | 213 |
| 251-01-5201 | 213 |
| 251-01-5211 | 213 |
| 251-01-5212 | 213 |
| 251-01-5225 | 213 |
| 251-01-5270 | 213 |
| 251-01-5271 | 213 |
| 251-01-5400 | 213 |
| 251-01-6201 | 159, 213 |
| 251-01-6211 | 159, 213 |
| 251-01-6225 | 159, 213 |
| 251-01-6230-JSP | 213 |
| 251-01-7204 | 213 |
| 251-01-7206 | 213 |
| 251-01-7214 | 213 |
| 251-01-7301 | 213 |
| 251-01-7311 | 213 |
| 251-01-7312 | 213 |
| 251-01-7313 | 213 |
| 251-01-7315 | 213 |
| 251-01-7401 | 213 |
| 251-01-7701 | 213 |
| 251-5300-000 | 208 |
| 251-5300-400 | 208 |
| 251-5300-400-RHB | 208 |
| 251-5300-402 | 208 |
| 251-60-000V | 208 |
| 251-60-0020 | 208 |
| 251-65-0020 | 209 |
| 251-65-0020-RHB | 209 |

INDEX

BRINGING THE BEST OF THE WORLD TO YOU®

| ITEM NUMBER | PAGE NUMBER |
|---------------------------------|-------------|
| 251-65-0021-RHB | 209 |
| 251-80-0020 | 208 |
| 251-80-0020-RHB | 208 |
| 252-CDL-06 | 214 |
| 252-CDS-12 | 214 |
| 252-FB30 | 214 |
| 252-FX-0001 | 214 |
| 252-L401 | 214 |
| 252-L404 | 214 |
| 252-L407 | 214 |
| 252-LCS08 | 214 |
| 252-LCT100 | 214 |
| 262-AEJ030-50 | 172 |
| 262-AEK010HV | 172 |
| 262-AEK020HV | 172 |
| 263-11001 | 172 |
| 263-41001 | 168 |
| 263-41002 | 168 |
| 263-41003 | 168 |
| 263-42001 | 168 |
| 263-42002 | 168 |
| 263-42003 | 168 |
| 263-43001 | 168 |
| 263-43002 | 168 |
| 263-43003 | 168 |
| 263-99400 | 172 |
| 263-99401 | 172 |
| 264-45002 | 169 |
| 264-45102 | 169 |
| 264-46002 | 169 |
| 264-46102 | 169 |
| 264-47002 | 169 |
| 264-47102 | 169 |
| 264-99403 | 172 |
| 265-100C | 170 |
| 265-200U | 170 |
| 267-HPB200 | 171 |
| 267-HPB300 | 171 |
| 267-HPD100 | 172 |
| 267-HPF200 | 170 |
| 267-HPF200-1 | 170 |
| 267-HPF200-1 | 172 |
| 267-HPF200C | 170 |
| 267-HPF200D | 171 |

| ITEM NUMBER | PAGE NUMBER |
|--------------------------------|-------------|
| 267-HPF300 | 170 |
| 267-HPF300-1 | 170, 172 |
| 267-HPF300C | 170 |
| 267-HPF700 | 170 |
| 267-HPF700C | 170 |
| 267-HPR200 | 171 |
| 267-HPR200C | 171 |
| 267-HPR300 | 171 |
| 267-HPR300C | 171 |
| 267-HPR300D | 171 |
| 270-1000 | 267 |
| 270-1101 | 267 |
| 270-2000 | 266 |
| 270-2050 | 266 |
| 270-3000 | 266 |
| 270-3050 | 266 |
| 270-4000 | 267 |
| 280-AHS150-10 | 150 |
| 280-AHS150-20 | 150 |
| 280-AHS150-50 | 150 |
| 280-AHS150V-10 | 150 |
| 280-AHS240-10 | 150 |
| 280-AHS240-20 | 150 |
| 280-AHS240-50 | 150 |
| 280-AHS240V-10 | 150 |
| 280-AJS260-10 | 156 |
| 280-EV6121-10 | 154 |
| 280-EV6121-20 | 154 |
| 280-EV6121-30 | 154 |
| 280-EV6121-39 | 154 |
| 280-EV6121-40 | 154 |
| 280-EV6121-50 | 154 |
| 280-EV6121-60 | 154 |
| 280-EV6121-LY | 154 |
| 280-EV6121-OR | 154 |
| 280-EV6131-10 | 154 |
| 280-EV6131-20 | 154 |
| 280-EV6131-30 | 154 |
| 280-EV6131-50 | 154 |
| 280-EV6131-60 | 154 |
| 280-EV6131-LY | 154 |
| 280-EV6131-OR | 154 |
| 280-EV6131V-10 | 154 |
| 280-EV6131V-20 | 154 |

| ITEM NUMBER | PAGE NUMBER |
|-----------------------------------|-------------|
| 280-EV6141-10 | 154 |
| 280-EV6141-20 | 154 |
| 280-EV6141-30 | 154 |
| 280-EV6141-50 | 154 |
| 280-EV6141-60 | 154 |
| 280-EV6141-LY | 154 |
| 280-EV6141-OR | 154 |
| 280-EV6141V-10 | 154 |
| 280-EV6141V-20 | 154 |
| 280-EV6151-10 | 153 |
| 280-EV6151-11 | 153 |
| 280-EV6151-20 | 153 |
| 280-EV6151-30 | 153 |
| 280-EV6151-39 | 153 |
| 280-EV6151-40 | 153 |
| 280-EV6151-50 | 153 |
| 280-EV6151-60 | 153 |
| 280-EV6151-LY | 153 |
| 280-EV6151M-10 | 156 |
| 280-EV6151M-20 | 156 |
| 280-EV6151M-30 | 156 |
| 280-EV6151M-50 | 156 |
| 280-EV6151M-60 | 156 |
| 280-EV6151MCR2-XX | 156 |
| 280-EV6151M-LY | 156 |
| 280-EV6151M-OR | 156 |
| 280-EV6151-OR | 153 |
| 280-EV6151S-10 | 153 |
| 280-EV6151S-20 | 153 |
| 280-EV6151SV-10 | 153 |
| 280-EV6151SV-20 | 153 |
| 280-EV6151SV-50 | 153 |
| 280-EV6151V-10 | 153 |
| 280-EV6151V-20 | 153 |
| 280-EV6151V-40 | 153 |
| 280-EV6151V-50 | 153 |
| 280-EV6151V-LY | 153 |
| 280-EV6151V-OR | 153 |
| 280-EV6161-10 | 152 |
| 280-EV6161-20 | 152 |
| 280-EV6161-30 | 152 |
| 280-EV6161-40 | 152 |
| 280-EV6161-50 | 152 |
| 280-EV6161-60 | 152 |

| ITEM NUMBER | PAGE NUMBER |
|-----------------------------------|-------------|
| 280-EV6161-LY | 152 |
| 280-EV6161M-10 | 156 |
| 280-EV6161M-20 | 156 |
| 280-EV6161M-30 | 156 |
| 280-EV6161M-50 | 156 |
| 280-EV6161M-60 | 156 |
| 280-EV6161MCR2-XX | 156 |
| 280-EV6161M-LY | 156 |
| 280-EV6161M-OR | 156 |
| 280-EV6161-OR | 152 |
| 280-EV6161V-10 | 152 |
| 280-EV6161V-20 | 152 |
| 280-EV6161V-30 | 152 |
| 280-EV6161V-40 | 152 |
| 280-EV6161V-50 | 152 |
| 280-EV6161V-60 | 152 |
| 280-EV6161V-LY | 152 |
| 280-EV6161V-OR | 152 |
| 280-ML5151-10 | 153 |
| 280-ML5151-20 | 153 |
| 280-ML5151-30 | 153 |
| 280-ML5151-39 | 153 |
| 280-ML5151-50 | 153 |
| 280-ML5151-60 | 153 |
| 280-ML5151-80 | 153 |
| 281-CAP-LED | 161 |
| 281-CL-SET | 158 |
| 281-CR2-10 | 157 |
| 281-CR2-10-BL | 157 |
| 281-CR2-10-GR | 157 |
| 281-CR2-10-OR | 157 |
| 281-CR2-10-RE | 157 |
| 281-CR2-10-YE | 157 |
| 281-CR2FB-10 | 157 |
| 281-CR2FB-10-BL | 157 |
| 281-CR2FB-10-GR | 157 |
| 281-CR2FB-10-OR | 157 |
| 281-CR2FB-10-RE | 157 |
| 281-CR2FB-10-YE | 157 |
| 281-CR2SW-10 | 157 |
| 281-CS-2PT | 159 |
| 281-CS-4PT | 159 |
| 281-CSD-2PT | 159 |
| 281-SB-CHN | 159 |

| ITEM NUMBER | PAGE NUMBER |
|-------------------------------------|-------------|
| 281-SB-NBF | 159 |
| 281-SB-NBF/CP | 159 |
| 281-SSE-CAP | 159 |
| 281-SSE-FB | 159 |
| 282-ABM130-11 | 160 |
| 282-ABM130-12 | 160 |
| 282-ABM130-21 | 160 |
| 282-ABR170-11 | 160 |
| 282-ABR170-12 | 160 |
| 282-ABR170-18 | 160 |
| 282-ABR170-21 | 160 |
| 282-ABR170-52 | 160 |
| 282-ABR170-62 | 160 |
| 282-ABR170-CAMO | 160 |
| 282-ABR170-LY | 160 |
| 282-ABR170-OR | 160 |
| 282-ABS150-11 | 160 |
| 282-ABS150-12 | 160 |
| 282-ABS150-18 | 160 |
| 282-ABS150-21 | 160 |
| 282-ABS150-62 | 160 |
| 282-AEM130-11 | 161 |
| 282-AEM130-21 | 161 |
| 282-AEP-10 | 161 |
| 282-AES150-11 | 161 |
| 282-AES150-21 | 161 |
| 282-AFB375-21 | 161 |
| 282-AFB375-LY | 161 |
| 289-GTW-6121-L/XL | 155 |
| 289-GTW-6121-M/L | 155 |
| 289-GTW-6121-M/M-39 | 155 |
| 289-GTW-6121-XL/XXL | 155 |
| 289-GTW-6141-L/XL | 155 |
| 289-GTW-6141-M/L | 155 |
| 289-GTW-6141-XL/XXL | 155 |
| 290-440L | 264 |
| 290-440M | 264 |
| 290-440S | 264 |
| 290-440XL | 264 |
| 290-440XXL | 264 |
| 290-550L | 264 |
| 290-550M | 264 |
| 290-550XL | 264 |
| 290-550XXL | 264 |

| ITEM NUMBER | PAGE NUMBER |
|-----------------------------|-------------|
| 290-9000L | 262 |
| 290-9000M | 262 |
| 290-9000S | 262 |
| 290-9000XL | 262 |
| 290-9001L | 262 |
| 290-9001M | 262 |
| 290-9001S | 262 |
| 290-9001XL | 262 |
| 290-9010BGE | 262 |
| 290-9010BLK | 262 |
| 290-9011BLK | 262 |
| 290-9013L | 262 |
| 290-9013M | 262 |
| 290-9013S | 262 |
| 290-9013XL | 262 |
| 290-9015 | 262 |
| 290-9020L | 263 |
| 290-9020M | 263 |
| 290-9020S | 263 |
| 290-9020XL | 263 |
| 291-100 | 263 |
| 291-110 | 263 |
| 291-130 | 263 |
| 299-13210 | 268 |
| 299-13215 | 269 |
| 299-13225 | 268 |
| 299-13255 | 268 |
| 299-13285 | 268 |
| 299-13290 | 268 |
| 299-13293 | 268 |
| 299-13295 | 270 |
| 299-17030 | 269 |
| 300-0800-LY | 227 |
| 300-0800-OR | 227 |
| 300-0900-LY | 227 |
| 300-0900-OR | 227 |
| 300-1000-BL | 227 |
| 300-1000-RD | 227 |
| 300-1502 | 226 |
| 300-1504 | 226 |
| 300-1505 | 226 |
| 300-1507 | 226 |
| 300-1508 | 226 |
| 300-1510 | 226 |

| ITEM NUMBER | PAGE NUMBER |
|-------------------------------|-------------|
| 300-1511 | 226 |
| 300-1516 | 226 |
| 300-2501 | 226 |
| 300-2502 | 226 |
| 300-2503 | 226 |
| 300-2504 | 226 |
| 300-2505 | 226 |
| 300-2506 | 226 |
| 300-2507 | 226 |
| 300-2508 | 226 |
| 300-2509 | 226 |
| 300-2510 | 226 |
| 300-2511 | 226 |
| 300-2512 | 226 |
| 300-2513 | 226 |
| 300-2514 | 226 |
| 300-2515 | 226 |
| 300-EVOR-E-LY | 227 |
| 300-EVOR-E-OR | 227 |
| 300-EVOR-P-LY | 227 |
| 300-EVOR-P-OR | 227 |
| 301-0150-LY | 227 |
| 301-0150-OR | 227 |
| 302-0210-LY | 221 |
| 302-0210-OR | 221 |
| 302-0211-LY | 221 |
| 302-0211-OR | 221 |
| 302-0212-LY | 221 |
| 302-0212-OR | 221 |
| 302-0215-LY | 224 |
| 302-0215-OR | 224 |
| 302-0500M-LY | 223 |
| 302-0500M-OR | 223 |
| 302-0500-LY | 223 |
| 302-0500S-LY | 223 |
| 302-0500S-OR | 223 |
| 302-0500-YEL | 223 |
| 302-0590E-LY | 221 |
| 302-0590E-OR | 221 |
| 302-0600D-LY | 224 |
| 302-0600D-OR | 224 |
| 302-0650D-LY | 223 |
| 302-0650D-OR | 223 |
| 302-0700-LY | 223 |

| ITEM NUMBER | PAGE NUMBER |
|--------------------------------|-------------|
| 302-0700-OR | 223 |
| 302-0702-LY | 218 |
| 302-0702-OR | 218 |
| 302-0702Z-LY | 218 |
| 302-0702Z-OR | 218 |
| 302-0750-LY | 223 |
| 302-0750-OR | 223 |
| 302-0800D-BK | 223 |
| 302-0800D-LY | 223 |
| 302-0800D-OR | 223 |
| 302-0900-LY | 223 |
| 302-0900-OR | 223 |
| 302-5PMV-LY | 221 |
| 302-5PMV-OR | 221 |
| 302-5PV-LY | 221 |
| 302-5PV-OR | 221 |
| 302-MAP-LY | 223 |
| 302-MAPM-LY | 223 |
| 302-MAPM-OR | 223 |
| 302-MAP-OR | 223 |
| 302-MVAT-LY | 224 |
| 302-MVAT-OR | 224 |
| 302-MVG-LY | 218 |
| 302-MVG-OR | 218 |
| 302-MVGZ4P-LY | 218 |
| 302-MVGZ4P-OR | 218 |
| 302-MVGZ-LY | 218 |
| 302-MVGZ-OR | 218 |
| 302-MV-LY | 224 |
| 302-MV-OR | 224 |
| 302-MVZP-LY | 224 |
| 302-MVZP-OR | 224 |
| 302-MVZT-LY | 224 |
| 302-MVZT-OR | 224 |
| 302-P070-LY | 226 |
| 302-PSV-BLK | 226 |
| 302-PSV-BLK-NL | 226 |
| 302-PSV-BLU | 226 |
| 302-PSV-BLU-NL | 226 |
| 302-PSV-GRN | 226 |
| 302-PSV-RED | 226 |
| 302-PSV-RED-NL | 226 |
| 302-USV5-LY | 221 |
| 302-USV5-OR | 221 |

| ITEM NUMBER | PAGE NUMBER |
|--------------------------------|-------------|
| 302-V100-LY | 218 |
| 302-V100-OR | 218 |
| 302-WCENG-LY | 218 |
| 302-WCENG-OR | 218 |
| 302-WCENGZ-LY | 218 |
| 302-WCENGZ-OR | 218 |
| 303-0500M-LY | 223 |
| 303-0500M-OR | 223 |
| 303-0500-OR | 223 |
| 303-0500-YEL | 223 |
| 303-0800D-LY | 223 |
| 303-0800D-OR | 223 |
| 303-5PMTT-LY | 221 |
| 303-5PMTT-OR | 221 |
| 303-HSVE-LY | 218 |
| 303-HSVE-OR | 218 |
| 303-MVGZ4P-LY | 218 |
| 303-MVGZ4P-OR | 218 |
| 305-2000 | 246 |
| 305-2100 | 246 |
| 305-3000 | 246 |
| 305-3100 | 246 |
| 305-5PVFR-LY | 225 |
| 305-5PVFR-OR | 225 |
| 305-HSSVFR-LY | 225 |
| 305-HSSVFR-OR | 225 |
| 305-HSVPFR-LY | 225 |
| 305-HSVPFR-OR | 225 |
| 305-MVFR-LY | 225 |
| 305-MVFR-OR | 225 |
| 305-USV5FR-LY | 225 |
| 305-USV5FR-OR | 225 |
| 305-WCENGFR-LY | 225 |
| 305-WCENGFR-OR | 225 |
| 310-1100-LY | 229 |
| 310-1100-OR | 229 |
| 310-1150B-LY | 229 |
| 310-950B-LY | 229 |
| 310-CNTSN-LY | 229 |
| 310-CNTSN-OR | 229 |
| 312-1200-LY | 229 |
| 312-1200-OR | 229 |
| 312-1250B-LY | 229 |
| 312-1250B-OR | 229 |

| ITEM NUMBER | PAGE NUMBER |
|-------------------------------------|-------------|
| 312-1350B-LY | 229 |
| 312-1350B-OR | 229 |
| 312-1360B-LY | 229 |
| 312-1360B-OR | 229 |
| 313-1300-LY | 229 |
| 313-1300-OR | 229 |
| 313-1375B-LY | 229 |
| 313-1375B-OR | 229 |
| 313-1400-LY | 229 |
| 313-1400-OR | 229 |
| 313-CNTSE-LY | 229 |
| 313-CNTSELY*-PRI18W | 141, 229 |
| 313-CNTSE-OR | 229 |
| 313-CNTSP-LY | 229 |
| 313-CNTSP-OR | 229 |
| 315-1350FR | 245 |
| 315-1350FR-LY | 229 |
| 318-1757-LY | 234 |
| 318-1757-OR | 234 |
| 318-1771-LY | 234 |
| 318-1771-OR | 234 |
| 319-GT1 | 234 |
| 319-GT2 | 234 |
| 319-MTP-LY | 234 |
| 323-1330B-LY | 230 |
| 323-1330B-OR | 230 |
| 323-1350B-LY | 230 |
| 323-1350B-OR | 230 |
| 323-1370B-LY | 230 |
| 323-1370B-OR | 230 |
| 323-CNSSE-LY | 230 |
| 323-CNSSE-OR | 230 |
| 323-HSSE-LY | 230 |
| 323-HSSE-OR | 230 |
| 323-HSSP-LY | 230 |
| 333-1550-LY | 233 |
| 333-1740-LY | 233 |
| 333-1740-OR | 233 |
| 333-1762-LY | 233 |
| 333-1762-OR | 233 |
| 333-1766-LY | 233 |
| 333-1766-OR | 233 |
| 333-1770-LY | 233 |
| 333-1770-OR | 233 |

| ITEM NUMBER | PAGE NUMBER |
|--------------------------------|-------------|
| 333-WB-LY | 233 |
| 333-WB-OR | 233 |
| 343-1755-LY | 233 |
| 343-1755-OR | 233 |
| 343-1756-LY | 233 |
| 343-1756-OR | 233 |
| 350-RANGER | 280 |
| 353-1000-LY | 239 |
| 353-1000-OR | 239 |
| 353-1048-LY | 239 |
| 353-1048-OR | 239 |
| 353-2000-OR | 239 |
| 353-2000-YEL | 239 |
| 353-2001-OR | 239 |
| 353-2001-YEL | 239 |
| 353-2002-OR | 239 |
| 353-2002-YEL | 239 |
| 355-2500AR-LY | 239 |
| 355-2501AR-LY | 239 |
| 355-2505AR-LY | 239 |
| 360-1500FR-BK | 165 |
| 360-BEANNIELY | 165 |
| 360-BEANNIEOR | 165 |
| 363-1ML2FB | 165 |
| 363-1RL2B | 165 |
| 363-1RL3QB | 165 |
| 363-1SL2FB | 165 |
| 364-1170 | 165 |
| 364-ML2FB | 165 |
| 364-ML2FMP | 165 |
| 364-ML2SB | 165 |
| 364-RL2B | 165 |
| 364-RL3QB | 165 |
| 364-SL1FB | 165 |
| 364-SL2FB | 165 |
| 364-SL2SB | 165 |
| 365-1502-BK | 165 |
| 365-1505-BK | 165 |
| 365-1510FR-BK | 165 |
| 365-1520FR-BK | 165 |
| 365-1620 | 165 |
| 385-1370FR | 244 |
| 385-1370FR-LY | 230 |
| 385-FRBL-11-NV | 256 |

| ITEM NUMBER | PAGE NUMBER |
|--------------------------------|-------------|
| 385-FRBL-11-OR | 256 |
| 385-FRCJ | 248 |
| 385-FRHN-LG | 245 |
| 385-FRHN-NV | 245 |
| 385-FRHN-OR | 245 |
| 385-FRLS-LG | 245 |
| 385-FRLS-NV | 245 |
| 385-FRLS-OR | 245 |
| 385-FRPH-NV | 245 |
| 385-FRPH-OR | 245 |
| 385-FRRJ | 248 |
| 385-FRSC-KH | 249 |
| 385-FRSC-NV | 249 |
| 385-FRSS-LG | 245 |
| 385-FRSS-NV | 245 |
| 385-FRWS-KH | 248 |
| 385-FRWS-NV | 248 |
| 385-FRZH-NV | 245 |
| 385-FRZH-OR | 245 |
| 385-HDFR13-NV | 256 |
| 385-HDFR13-OR | 256 |
| 390-10 | 276 |
| 390-EZ100 | 276 |
| 390-EZ150 | 276 |
| 390-EZ202 | 276 |
| 390-EZFRPC | 276 |
| 390-EZSPC | 276 |
| 390-PC099 | 276 |
| 390-PCVCP1 | 276 |
| 390-PCVKT1 | 276 |
| 393-100-BLU | 277 |
| 393-100-CBL | 277 |
| 393-100-CRD | 277 |
| 393-100-DGC | 277 |
| 393-100-KHK | 277 |
| 393-100-NAVY | 277 |
| 393-100-PAT | 277 |
| 393-650-B | 277 |
| 393-650-L | 277 |
| 393-650-P | 277 |
| 393-EZ201-KHK | 277 |
| 393-EZ201-NVY | 277 |
| 393-EZ201-PAT | 277 |
| 393-EZ201-RTC | 277 |

INDEX

BRINGING THE BEST OF THE WORLD TO YOU®

| ITEM NUMBER | PAGE NUMBER | ITEM NUMBER | PAGE NUMBER |
|-------------------------------|-------------|----------------------------------|-------------|
| 396-20870-BGE | 280 | 903-GB652 | 162 |
| 396-20870-NAV | 280 | 903-GB653 | 162 |
| 396-300-CBL | 278 | 906-100NOM7 | 166 |
| 396-300-NAV | 278 | 906-100NOM7B | 166 |
| 396-300-PAT | 278 | 906-100NOM7BLKB | 166 |
| 396-400-BLU | 279 | 906-208ONOL7 | 166 |
| 396-405 | 279 | 906-208ONOL7B | 166 |
| 396-425-KHK | 278 | 906-208ONOL7BLK | 166 |
| 396-500 | 280 | 906-208ONOL7BLKB | 166 |
| 396-505 | 280 | 906-8416CBX | 166 |
| 396-602-B | 277 | 906-8416CT | 166 |
| 396-602-L | 277 | 910-P735 | 127 |
| 396-602-P | 277 | 910-P775 | 127 |
| 396-700FR-LY | 280 | 911-AX9 | 128 |
| 396-700FR-OR | 280 | 911-AX9P | 128 |
| 396-800 | 280 | 935-004 | 274 |
| 396-801FR | 280 | 935-006B | 274 |
| 396-EZ205 | 278 | 939-AT280-A | 273 |
| 396-EZ205-RTC | 278 | 939-AT280-R | 273 |
| 396-EZ450-KHK | 278 | 939-AT290-A | 272 |
| 396-EZ450-LY | 278 | 939-AT290-B | 272 |
| 396-EZ450-RTC | 278 | 939-AT290-G | 272 |
| 396-EZ810 | 279 | 939-AT290-R | 272 |
| 396-EZ811FR | 279 | 939-AT290-W | 272 |
| 396-EZ900-GC | 277 | 939-AT293-A/W | 272 |
| 396-EZ900-LY | 277 | 939-AT293-B/W | 272 |
| 396-EZ900-NV | 277 | 939-AT293-R/A | 272 |
| 396-EZ900-PK | 277 | 939-AT293-R/B | 272 |
| 399-HEATPACK | 119 | 939-AT293-R/W | 272 |
| 805-3455 | 162 | 939-EF350-A | 273 |
| 805-3479 | 162 | 939-EF350-R | 273 |
| 828-0378 | 163 | 939-EFAVBASE | 273 |
| 828-0379 | 163 | 939-EFBAG-2 | 273 |
| 828-0380 | 163 | 939-EFBAG-4 | 273 |
| 828-0382 | 163 | 939-EFBASE | 273 |
| 841-0398 | 163 | 939-EFCLIP | 273 |
| 841-0399 | 163 | 939-EFFLCL/L | 273 |
| 841-0400 | 163 | 939-EFMAGBASE | 273 |
| 841-0401 | 163 | 939-EFMAGCLIP | 273 |
| 856-6323 | 162 | 939-TB10-R | 273 |
| 856-6324 | 162 | 939-TF250-B-ASY | 273 |
| 856-6325 | 162 | 9010-51200 | 260 |
| 856-6326 | 162 | 9100-2100D | 249 |
| 903-GB651 | 162 | 9100-2110D | 249 |

| ITEM NUMBER | PAGE NUMBER | ITEM NUMBER | PAGE NUMBER |
|-----------------------------|-------------|-----------------------------|-------------|
| 9100-2120D | 249 | 9100-52422 | 247 |
| 9100-2160D | 247, 249 | 9100-52424 | 247 |
| 9100-2170D | 247, 249 | 9100-524UL | 247, 253 |
| 9100-21721 | 247 | 9100-52564 | 247 |
| 9100-21731 | 247 | 9100-52680 | 247 |
| 9100-21782 | 247 | 9100-52750 | 247 |
| 9100-22070 | 247 | 9100-52758 | 247 |
| 9100-240UL | 247 | 9100-52772 | 247 |
| 9100-52412 | 247 | 9100-530UL | 247, 253 |
| 9100-52422 | 247 | 9100-53680 | 247 |
| 9100-524UL | 247, 253 | 9100-53750 | 247 |
| 9100-52564 | 247 | 9100-75000 | 247 |
| 9100-52680 | 247 | 9100-75001 | 247 |
| 9100-52750 | 247 | 9100-HDFR12 | 256 |
| 9100-52758 | 247 | 9100-HDFR15 | 256 |
| 9100-52772 | 247 | 9150-21712 | 252 |
| 9100-530UL | 247, 253 | 9150-5236V | 253, 255 |
| 9100-53680 | 247 | 9150-523UL | 253, 255 |
| 9100-53750 | 247 | 9150-52436 | 252 |
| 9100-75000 | 247 | 9150-52436B | 252 |
| 9100-75001 | 247 | 9150-52500 | 251 |
| 9150-21712 | 252 | 9150-52508 | 251 |
| 9150-5236V | 253, 255 | 9150-52512 | 251 |
| 9150-523UL | 253, 255 | 9150-52515 | 255 |
| 9150-52436 | 252 | 9150-52548 | 255 |
| 9150-52436B | 252 | 9150-52609 | 252 |
| 9150-52500 | 251 | 9150-52685 | 255 |
| 9150-52508 | 251 | 9150-52689 | 255 |
| 9150-52512 | 251 | 9150-52730 | 252 |
| 9150-52515 | 255 | 9150-52730B | 252 |
| 9150-52548 | 255 | 9150-52804 | 251 |
| 9150-52609 | 252 | 9150-52810 | 251 |
| 9150-52685 | 255 | 9150-52815 | 252 |
| 9150-52689 | 255 | 9150-52821 | 252 |
| 9150-52730 | 252 | 9150-52850 | 255 |
| 9150-52730B | 252 | 9150-52917 | 252 |

| ITEM NUMBER | PAGE NUMBER | ITEM NUMBER | PAGE NUMBER |
|-----------------------------|-------------|-----------------------------|-------------|
| 9150-52946 | 252 | 9150-5388E | 251 |
| 9150-53003 | 252 | 9150-540UL | 252 |
| 9150-53018 | 252 | 9150-540ULB | 252 |
| 9150-53018 | 252 | 9150-5488E | 251 |
| 9150-53871 | 251 | 9150-5488EB | 251 |
| 9150-5388E | 251 | 9150-54VUL | 252 |
| 9150-5388EB | 251 | 9150-54VULB | 252 |
| 9150-540UL | 252 | 9150-56510 | 251 |
| 9150-540ULB | 252 | 9150-56511 | 251 |
| 9150-5488E | 251 | 9150-75002 | 255 |
| 9150-5488EB | 251 | 9150-75050 | 252 |
| 9150-54VUL | 252 | 9150-75050B | 252 |
| 9150-54VULB | 252 | 9400-52501 | 254 |
| 9150-56510 | 251 | 9400-52502 | 254 |
| 9150-56511 | 251 | 9400-52503 | 254 |
| 9150-75002 | 255 | 9400-52504 | 254 |
| 9150-75050 | 252 | 9400-52505 | 254 |
| 9150-75050B | 252 | 9400-52506 | 254 |
| 9400-52501 | 254 | 9400-52507 | 254 |
| 9400-52502 | 254 | 9400-52508 | 254 |
| 9400-52503 | 254 | 9400-52509 | 254 |
| 9400-52504 | 254 | 9400-52511 | 254 |
| 9400-52505 | 254 | 9400-52514 | 256 |
| 9400-52506 | 254 | 9400-52517 | 255 |
| 9400-52507 | 254 | 9400-52599 | 256 |
| 9400-52508 | 254 | 9400-52686 | 255 |
| 9400-52509 | 254 | 9400-52699 | 255 |
| 9400-52511 | 254 | 9400-53502 | 254 |
| 9400-52514 | 256 | 9400-53504 | 254 |
| 9400-52517 | 255 | 9400-53512 | 254 |
| 9400-52599 | 256 | 9400-53514 | 254 |
| 9400-52686 | 255 | 9400-53520 | 254 |
| 9400-52699 | 255 | 9400-80016 | 254 |
| 9400-53502 | 254 | | |
| 9400-53504 | 254 | | |
| 9400-53512 | 254 | | |
| 9400-53514 | 254 | | |
| 9400-53520 | 254 | | |
| 9400-80016 | 254 | | |

TRADEMARKS

3GX®, ACP™, Adversary™, Air Force™, Ambi-dex™, Ambi-Thix®, Anti-ReflectivePLUS™, ArmorFlex®, ArmorGrip®, ArmorLite®, ArmorLiteXT®, AmorTuff™, AmorTuff XT®, Assurance®, Assurance® Plus, AutoXT™, Black Pearl, Blue Bison™, Bouton™ Optical, Bringing the Best of the World to You®, Brahma Quality®, Cabaret™, ChemGrip™, CleanTeam™, Cut Risk Hazard Matrix™, Double V™, Duo-Pro™, E-Flare™, ESP™, Eva®, Excalibur®, EZ-COOL™, Falcon™, FingerNails®, FlashFire™, Fogless® 3Sixty™, Fuselage™, GP™, Great White®, Grippaz™, G-Tek®, Hi-Voltage AC™, Hi-Voltage ARC™, KEV™, K-Force™, Lady Eva®, Mag Readers™, Maximum Safety™, MirrorPLUS™, Neofoam™, PermFlex™, PolarizedXL5™, PolyKor™, Pritex™, ProCoat™, Red Viper™, SafetyGear by PIP®, Smart Fit™, Supreme™, The Scout™, U-Fit®, XCrystal™, XtraTuff™, Zenon Z11sm™, Zenon Z12™, Zenon Z12R™, Zenon Z13™, Zenon Z14sm™, Zenon Z28™, Zenon Z36™, and Zenon Z44™ are registered trademarks or trademarks pending registration of Protective Industrial Products, Inc.

Active™, AD-APT®, AIRtech®, Comfort™, Elite™, Endurance™, MaxiChem®, MaxiCut®, MaxiCut® Ultimate DT™, MaxiDry®, MaxiDry® Plus™, MaxiDry® Zero™, MaxiFlex® Ultimate™ and MaxiFoam™, are registered trademarks or trademarks pending registration of ATG®.

EverGrip™, Kut Gard® and Temp-Gard® are registered trademarks or trademarks pending registration of PR Industries.

Dare Bigger™, DuPont®, Kevlar®, Lycra®, Nomex® and Protera® are trademarks or registered trademarks of E.I. du Pont de Nemours and Company.

Velcro® is a registered trademark of Velcro Industries B.V.

3M™ and Thinsulate™ are trademarks of 3M™.

Dyneema® is a registered trademark of DSM.

HyperKewl™ is a trademark of TechNiche International.

REALTREE® is a registered trademark of Jordan Outdoor Enterprises, Ltd.

UltraSoft® is a registered trademark of Westex®.

Actifresh® is a registered trademark of British Sanitized Limited.

Aerolite™, Bushmaster™, Classic™ Extreme, Comfort Plus™, EasyJust®, EVOLite® Skyworker™, Evolution®, EVOSpec™, Hard Cap A1+™, Inter EXV™, Inter GPV™, J Muff™, MKB Evolution®, PowerCap®, Surefit™ and Top Cap™, are registered trademarks or trademarks pending registration of JSP®.

Secure™ is a trademark of Hellberg® Safety AB.

Novax® is a registered trade mark of GB Industries.

ActivGrip™ Advance, ActivGrip™, MicroFinish™, N-Spector XRT and PowerGrab® are registered trademarks or trademarks pending registration of the TOWA Corporation.

LIMITED WARRANTY

Protective Industrial Products, Inc.® (PIP) warrants only that PIP products will be free from defects in materials and workmanship at the time of sale. Upon receipt of each shipment, the customer must examine the products for defect or shortage and notify PIP in writing within thirty (30) days after such receipt of any claims reasonably discernible within such thirty (30) day period. All claims not reasonably discernible within thirty (30) days must be made in writing within one (1) year after receipt of shipment. Any claim not timely made shall be waived. This limited warranty is exclusive and in lieu of all other warranties, express, implied or statutory. PIP's entire obligation and the exclusive remedy to any party for breach of this limited warranty shall be limited to replacement of the defective product or refund of the original purchase price of the product, at PIP's option. PIP's limited warranty shall not apply to PIP products that have been subject to misuse, accident, negligence, handling, storage, or use.

DISCLAIMER OF IMPLIED WARRANTIES

All implied warranties which may arise by implication of law or application, course of dealing, usage of trade, including, but not limited to, implied warranties of merchantability, fitness for a particular purpose title, and non-infringement are expressly excluded. The user is solely responsible for the suitability of the product selected for a particular application. This catalog is the exclusive property of Protective Industrial Products, Inc.® It may not be copied, duplicated or reproduced in whole or in part by any means without the written permission of Protective Industrial Products, Inc.®

TRIAL-ORDER PROGRAM

Trial orders are available to customers of Protective Industrial Products distributors on a satisfaction or no-pay basis. The program lets end-users evaluate PIP gloves, in their actual application and on-site condition, on a satisfaction-or-they-don't-pay basis to make sure they're the right gloves for the job. For more information about our "Satisfaction-or-No-Pay" guaranteed Trial Order Program, please contact your PIP Sales Representative.



PROTECTIVE INDUSTRIAL PRODUCTS, INC.

BRINGING THE BEST OF THE WORLD TO YOU®

AMERICAS

Corporate Headquarters & Sales Center
Latham, NY
Phone: 518-861-0133 · Toll Free: 800-262-5755
sales@pipusa.com · www.pipusa.com

New York Distribution Center
Guiderland Center, NY

California Sales & Distribution Center
Rancho Cucamonga, CA
Phone: 909-987-2350 · Toll Free: 800-225-9225

Tennessee Sales & Distribution Center
Memphis, TN
Phone: 901-370-5828 · Toll Free: 888-456-8378

USA Manufacturing Facility
Guiderland Center, NY

USA Manufacturing Facility
Bluffton, IN
Phone: 260-824-8146

USA Manufacturing Facility
Chaska, MN
Phone: 952-448-7430

Canada Distribution Center, Shipments & Returns
Bolton (Toronto), Ontario
Phone: 800-262-5755 x7258
www.pipcanada.ca

Mexico Sales & Distribution
Monterrey, N.L., Mexico
Phone: +52 (81) 8372-1825
www.pipmex.com

Mexico Regional Sales Office
San Pedro Garza Garcia, N.L., Mexico
Phone: +52 (81) 8335-4744 · +52 (81) 1365-9569

Latin America Independent Affiliate
Panamá, República de Panamá
Phone: (+507) 263-0175

Distributed by:

EUROPE

France Administrative & Sales Offices
L'hermenault, France
Phone: + 33 (0) 2 51 50 19 80
www.pipeurope.com

Spain Logistics & Distribution
Marines (Valencia), Spain
Phone: +34-96182.41.48

Greece Independent Affiliate
Athens, Greece
Phone: +30-210-3463910

ASIA PACIFIC

Asia Pacific Administrative Headquarters
Hong Kong, China
Phone: 852-2475-9228
www.pipasiapacific.com

China Administrative & Sales Center
Shanghai, China
Phone: 86-021-63170303

China Regional Sales Office
Yantai City, Shandong Province, China
Phone: 86-0535-6602843

Singapore Sales Office
Singapore
Phone: +65-91557756

Malaysia Sales Office
Penang, Malaysia
Phone: 6-04-399-3328

AUSTRALIA

Australia Independent Affiliate
Eagle Farm, Queensland, Australia
Phone: 1300 656 010
www.pipaus.com



616314225499

Part Number:
.84256

2/2017 • 60M
© Copyright 2017 Protective Industrial Products, Inc.
Printed in the U.S.A.

WWW.PIPUSA.COM